

AMIGA FORMAT

ISSUE 44 ■ MARCH 1993 ■ £3.25

Great Guns!
On this issue!
Psygnosis' *Hired Guns*
Our best ever game demo

Unlock the power of your Amiga!

The Amiga Format Instant Software Library - from word processing to ray tracing. We name the best buys and the biggest bargains!



Hard Driving

Get more from your Amiga with a hard drive. We tell you how to get the most K for the least cash!

AMIGA Arcade Issue 44
FORMAT

Hired Guns
Our best demo ever! Spectacular sci-fi roleplaying from Psygnosis and DMA Design. Don't miss it!

Voltage Controller
DIY hardware project. AMOS example program included.

Bootfix
Now Workbench 1.3 users can store their bootblocks against the virus threat.

Source code to read a four-button joystick

Devpac continued

1 Mb needed • All Amigas • 1 Mb needed

Personal Paint versus Deluxe Paint IV AGA

It's a 256-colour war as the new breed of paint packages fight for the honours!

REVIEWED: Wing Commander Dark Seed, Legends of Valour, Sleepwalker, and lots more!
PAGESETTER 3: Budget DTP in 256 colours tested inside

Future
PUBLISHING
Your guarantee of value



Award winning innovative products from



Scanners

"If you're in the market for a hand scanner then forget the rest and get Powerscan"

Amiga Format July 1992

Power Scanner v3.0



- 100-400 DPI scanning resolutions
- 64 greyscales
- Thru'port for printer
- Award winning editing, image manipulation & scanning software

Power Scanner v3.0£115
Power Scanner Colour£239

Epson GT-6500



- 600 DPI Colour flatbed scanner
- 24-bit colour
- Software included

GT-6500 inc. Powerscan v3.0£799
GT-6500 inc. ASDG Software.....£899
Transparency Adaptor Unit.....£499
Document Feeder.....£399

Epson GT-8000

- 800 DPI colour flatbed scanner
- 24-bit colour
- Software included

Epson GT-8000£1199

Upgrade Offers

If you consider your scanner system to be inferior to the Power Scanner, we will happily upgrade your software and interface. (Power Scanner is compatible with most scanning heads)

v3.0 Upgrade (inc. interface).....£49.95
v3.0 Software upgrade for PowerScanner users (send SAE)£15

The Amiga can only display 16 greyscales

Floppy Drives

"This drive contains more gadgets than Batman's utility belt"

Amiga Computing Feb 1992

PC880B Power Drive



- Award winning drive manufactured by Power Computing
- Super slim design
- Anti-click (Cures that annoying click)
- Virus blocker (Prevents viruses)
- Built-in backup hardware

PC880B with Blitz Amiga£60
PC880B with Blitz & XCopy£75
PC880B (Cyclone compatible)*£65
PC880B in black case£65

*This drive is only available to registered owners of XCopy Professional. You must provide proof of purchase of XCopy Professional

Power Drives

PC880E Economy drive£49.95
PC881 A500 Internal drive£40.00
PC882 A2000 Internal drive£45.00

Dual Drive

- Two high quality disk drives built into one compact unit
- Same features as PC880B

Dual drive£125

Blitz Amiga

- Backup disks at lightning speeds
- Stops all external drives from clicking
- Contains anti-virus from being written into the bootblocker

Blitz Amiga£20

1.44MB Power Drive

- 1.44MB disk drive
- High density floppy disk drive

1.44MB Power Drive £POA

PCMCIA Memory

- Ultra slim memory cards
- 1MB & 2MB
- For A600/A1200

1MB Memory card£POA
2MB Memory card£POA

RAM Expansions

A600 Memory Cards

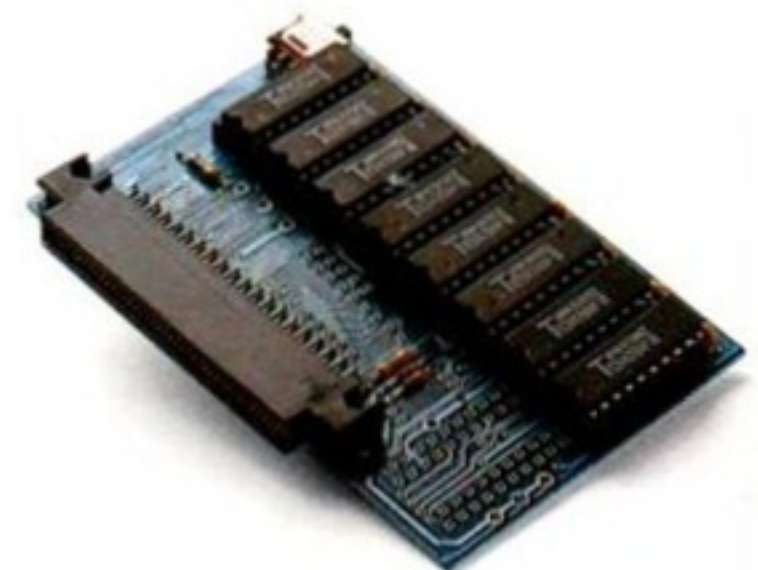

1MB RAM with clock£39.95
1MB RAM without clock£34.95

PC501+ RAM Card

Our RAM board is designed especially for the A500+ computer and comes with 1MB of RAM on board to expand your memory to 2MB of chip RAM. Plug-in and go operation (Fits into the trapdoor)

PC501+ RAM card£35.95

8MB for any A500

- Plugs into side slot, fully auto config, full thru'port. Expand 2MB-8MB

2MB £109 4MB £169 8MB £289
1 x 4ZIP chips£14.95

2MB for any A500

- Economy 2MB RAM externally cased
- 16-chip (1 x 1 DIP)
- No thru'port

2MB RAM£79

1.5MB RAM Board

- Fully supports 1MB of chip RAM
- Fully compatible with Fatter Agnus (Kickstart 1.3 and above, not compatible with A500+) (Your Amiga needs to be opened, this may effect your warranty)

1.5MB RAM board£75

1MB with Thru'port

- Expand your A500's memory up to a total of 2MB without disposing of your existing 512K upgrade
- Works with 1MB of Chip RAM

(512K RAM must be 4 chip type or not exceeding 9cm in length) (Your Amiga needs to be opened, this may effect your Warranty)

1MB with thru'port£45

A500 RAM Card

- 512K RAM expansion with clock & free software (A500+ compatible)

512K RAM (4 chip)£29
512K RAM without clock£24
512K RAM (16 chip) with clock£24
512K RAM (16 chip) without clock£19

Auto ROM Sharer



- Kick-off is the latest Amiga add-on from Power
- One of the most advanced kickstart ROM sharers available
- A clever design on a small reliable board
- Fits A500, A500+, A1500
- Kickstart ROM can be selected from the keyboard
- No messing about with switches
- No "CIA adaptor" or other trailing wires
- Jumper to select which ROM boots on switches
- Compatible with old Amiga board revisions
- Simple internal fitting*

* Kick-off requires the lid to be removed from the Amiga. This may invalidate your warranty.

ROM Share	£17.95
ROM Share inc. kickstart v2.04	£55
ROM Share inc. kickstart v1.3	£39
ROM Share for A600	£29

Kickstart v2.04

2.04 Kickstart (chip only)	£39.95
2.04 Kickstart ROM, workbench software, install disk 2.04, font disk & extras	£79.95
2.04 kit with ROM sharer	£99

Video Backup System

- Use VCR as a backup storage device
- Blank video tape is all that is required
- 200 Amiga floppy disks will fit on a 4 hour tape
- Can be used for hard disk backup
- There is room for 175MB of data
- Backup an Amiga diskette in 1 minute
- Restore even to an unformatted disk
- Hard disk backup, software allows you to specify which files and directories to be stored
- Low cost storage, 2 pence per MB
- Menu driven software
- Allows you to watch TV on a 1084s monitor
- Very high reliability
- Log files, contain title and counter position of every backup
- Video connection check, ensures fool proof operation
- Effective error-correction scheme
- Easy to understand manual

Video Backup System	£59.95
---------------------------	---------------

A500 Hard Drives

GVP A530 Turbo HD



- 40MHz 68030EC accelerator
- Optional 68882 maths co-processor
- Up to 8MB 32-bit FASTRAM on-board
- Award winning

42QMB HD 0MB RAM	£549
80QMB HD 0MB RAM	£649
240MB HD 0MB RAM	£1054
68882 Upgrade kit	£224

GVP Series 2 HD

- Up to 8MB FASTRAM on board
- | | | | |
|-----------------|-------------|-----------------|-------------|
| 40QMB 0MB | £329 | 80QMB 0MB | £399 |
| 40QMB 2MB | £379 | 80QMB 2MB | £449 |
| 40QMB 4MB | £440 | 80QMB 4MB | £499 |
| 40QMB 8MB | £509 | 80QMB 8MB | £549 |

ICD Novia Internal HD

- Fits inside your Amiga 500
 - Comes complete, just plug-in and go
- | | |
|-------------------------|-------------|
| Novia 40I 40MB HD | £279 |
| Novia 80I 80MB HD | £349 |

ICD Flicker Fixer

Flicker Free Video 2

- Stop that annoying flicker
 - Fits internally in the A500
 - Multi-sync monitor required
- | | |
|----------------------------------|-------------|
| Flicker Free Video 2 | £199 |
| NEC 4FG Multi-sync monitor | £549 |

Chips

4MB x 8SIMM	£90
1MB x 8SIMM	£25
256K x 4DRAM	£4.00
1MB x 1DRAM	£3.95
1 x 4 ZIP	£14.95
1 x 4 DIP	£19.95
A3000 Static column RAM	£19.95
SIMM 32 x 1MB-60	£65
SIM 32 x 4MB-60	£243

(These chips cover most memory & hard drives i.e. GVP, Supra, Commodore)

The Power BBS

- Free technical and buying advice
- Thousands of free files available for download
- Great discounts on all Power products
- On-line ordering to ensure speed of delivery
- Conferencing with top computer magazines
- Regular bulletins with latest product information

The Power House BBS

0 2 3 4 8 4 1 5 0 3

24 hours

All speeds up to 16.8K

Commodore CDTV



- CDTV player
 - Welcome disk + caddy
 - Keyboard
 - Floppy disk drive (black)
 - Wired mouse
 - Workbench 1.3 and manuals
 - Infrared remote control
- | | |
|---------------------------------|-------------|
| CDTV multi-media pack | £599 |
| A570 CD-ROM drive for A500..... | £349 |

CDTV Software

A Bun for Barney.....	£29.99
Barney Bear goes camping	£29.99
Battlechess	£39.99
Case of the Cautious Condor	£34.99
CD Remix v2	£34.99
Fred Fish CDPD Collection	£19.95
Fun School 3 (under 5's)	£24.99
Fun School (5-7yrs)	£24.99
Fun School (Over 7yrs)	£24.99
Guinness CDTV Disc of Records	£34.99
Illustrated Holy Bible	£29.99
Music Maker	£34.99
NASA Heroic Age of Space	£19.99
Power Pinball	£29.99
Sim City	£29.99
Trivial Pursuit	£49.99
World Vista Atlas	£54.99
Xenon 2 Megablast	£29.99

More titles available

POWER

Award Winning Manufacturers

Power products come with full technical support

"The Power Mouse is my pick of the month" **CU Amiga**

PC880B "Well worth spending your hard earned pennies on, an excellent buy" **Amiga Computing**

Dual Drive "Now this is a bit special" **Amiga Computing**

Power Scanner **Amiga Shopper Best Buy**

Power Scanner **Amiga Format Gold**

"Power Scan is quite simply the best Amiga hand scanner available" **Amiga Format**

Credit Card Hotline

0234 843388
1 0 L I N E S

Fax **0234 840234**

Technical **0234 841882**

VAT included

(UK mainland only)
48Hr delivery **£2.50**
24Hr delivery **£4.50**
Parcel post delivery **£1**
(Not for orders over **£50**)

Power Computing Ltd
Unit 8 Railton Road
Woburn Road Ind. Estate
Kempston Bedford
MK42 7PN



Established 1985

Specifications & prices subject to change with out notice
All trademarks acknowledged

AMIGA FORMAT 44 MARCH 1993

EDITORIAL DEPARTMENT

EDITOR Marcus Dyson
REVIEWS EDITOR Neil Jackson
TECHNICAL EDITOR Pat McDonald
PRODUCTION EDITOR Gary Lord
STAFF WRITER Andrew Nuttall
PRODUCTION ASSISTANT Stephen Bradley

ART DEPARTMENT

ACTING ART EDITOR Sue White
DESIGN Derek Davis

ADVERTISING DEPARTMENT

GROUP AD MANAGER Jonathan Bint
AD MANAGER Duncan Ferguson
SENIOR SALES EXEC Robert Anderson
SALES EXEC Anne Green

PUBLISHING

ADVERTISING PRODUCTION Tracey O'Donnell
PROMOTIONS ASSISTANT Tamara Ward
CIRCULATION DIRECTOR Sue Hartley
CIRCULATION ASSISTANT Kate Elston
PUBLISHER Greg Ingham
ASSISTANT PUBLISHER Damien Noonan

ADVERTISING COMPLAINTS

Contact Alison Winter, Advertising Complaints,
 30 Monmouth Street, Bath BA1 2BW

PRINTED IN THE UK BY

Chase Web Ltd, St Ives PLC, Plymouth
NEWSTRADE DISTRIBUTION, UK
 Future Publishing, 0225 442244
NEWSTRADE DISTRIBUTION, OVERSEAS
 MMC Ltd 0483 211222

AMIGA FORMAT

30 Monmouth Street
 Bath, Avon, BA1 2BW
 Telephone 0225 442244
 Facsimile 0225 446019

SUBSCRIPTIONS, BACK ISSUES and MAIL ORDER

Future Publishing, Somerton,
 Somerset, TA11 6TB

Telephone 0458 74011
 Facsimile 0458 74378



No part of this publication may be transmitted or reproduced in any form without the permission of the publishers.

Thought of the month:
 What are Axl Rose and
 Erinsbrough anagrams of?

Member of the Audit Bureau of Circulations.
 Registered Circulation
ABC 161,256
 Jan - July 1992

News

A1200 repair problem! 15
 Have Commodore left A1200 owners out in the cold?

More news of Amiga Format Live! 19
 Commodore give our show the thumbs up.

Screenplay

59

Adrenalynn108
Bubble Dizzy110
Dark Seed68
Dragon's Lair 398
European Soccer87
Exodus65
Fatal Strokes81
First Class110
FreeWheel racing controller105
Gem'X109

Legends of Valour90
Mega Mix Compilation110
Pipemania108
The Power108
PP Hammer and his Pneumatic Weapon108
Sleepwalker60
Sports Masters Compilation111
Tearaway Thomas72
Trolls86
Wing Commander94

Gamebusters 121
 Full solution for Beast 3 and many more hot game tips

Mastering AMOS 114
 How to use your AMOS Coverdisk to create a game

Reviews

Deluxe Paint IV AGA 132
 The latest version of Electronic Arts' classic.

Personal Paint 136
 A new arrival on the Amiga paint scene, with 256 colours!

Art Expression 138
 Soft Logik's long awaited entry into structured drawing

Dream GMX1 142
 A bargain sound module for all Amiga music fans

PageSetter 3 146
 The new version of Gold Disk's complete DTP system

Clarity 16 149
 16-bit sampling on a budget from Microdeal

Colour Scanners 154
 New offerings from Power and Epson

Excellence! 158
 A new word publisher, from the makers of Scribble!

Regulars

PD 177
 A look at the month's new free and shareware

Workbench 187
 Pat McDonald tackles your technical queries

Answerfile 192
 More technical advice for those niggling little problems

Letters 195
 Have your say, and see what others have to say

Special offers 172
 Amazing Amiga bargains specially selected for you

Subscriptions 168
 Save money on a year's worth of AF, and get a free gift

Competition

Win a fabulous LED printer 162
 Two fabulous OL-400 printers, worth £2,200, up for grabs



REVIEWED
DPaint 4 AGA

DeluxePaint can now handle more colours than you could shake a stick at. We see if it's retained its old virtues
 Page 132



REVIEWED
PageSetter 3

A flexible DTP package, with integral paint program and word processor, for the price of a round of drinks*
 Page 146

* for 30 people



REVIEWED
Epson GT-6500

This new flatbed colour scanner brings the same professional quality we've come to expect from Epson, at an even lower price.
 Page 154

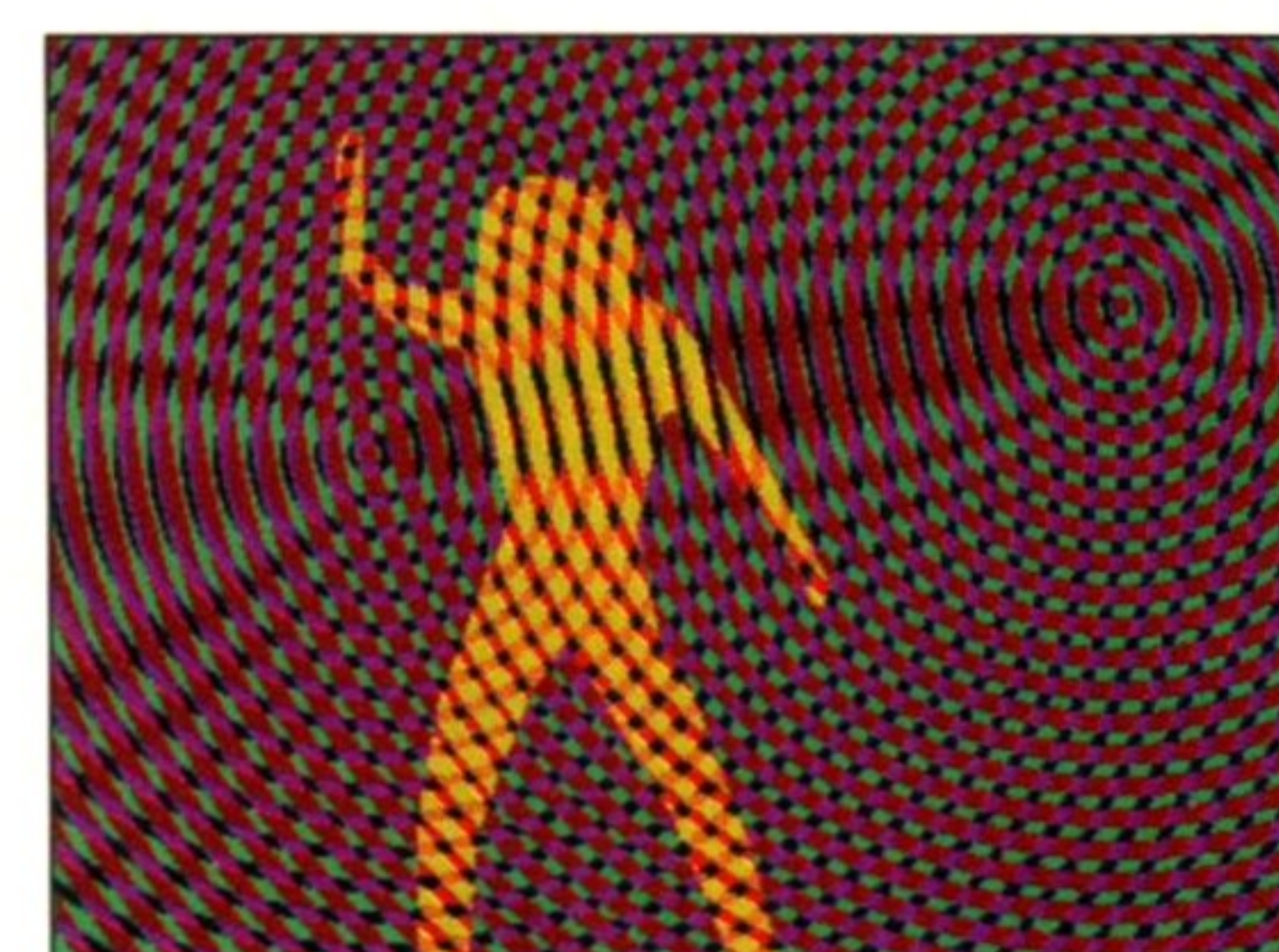

IN PD DEMOS:

State of the Art, as its name suggests, is a state-of-the-art PD demo. Get the low down on this and more in Demo Zone
 Page 177



WIN A PRINTER...

If you can answer 10 simple questions. OK, they're not simple, but what do you expect with a prize this good?
 Page 162

Unlock your Amiga's secret power

They say that you get out of life what you put into it, which may or may not be correct. But it's certainly true when it comes to your Amiga, if you put better software in you'll get better results out.

So, just imagine what would happen if you put the best software there was into your machine! Then you could really unlock the power of your Amiga! But how can you find out which programs are among this hallowed category? We'll tell you how, just turn straight to...

PAGE 29

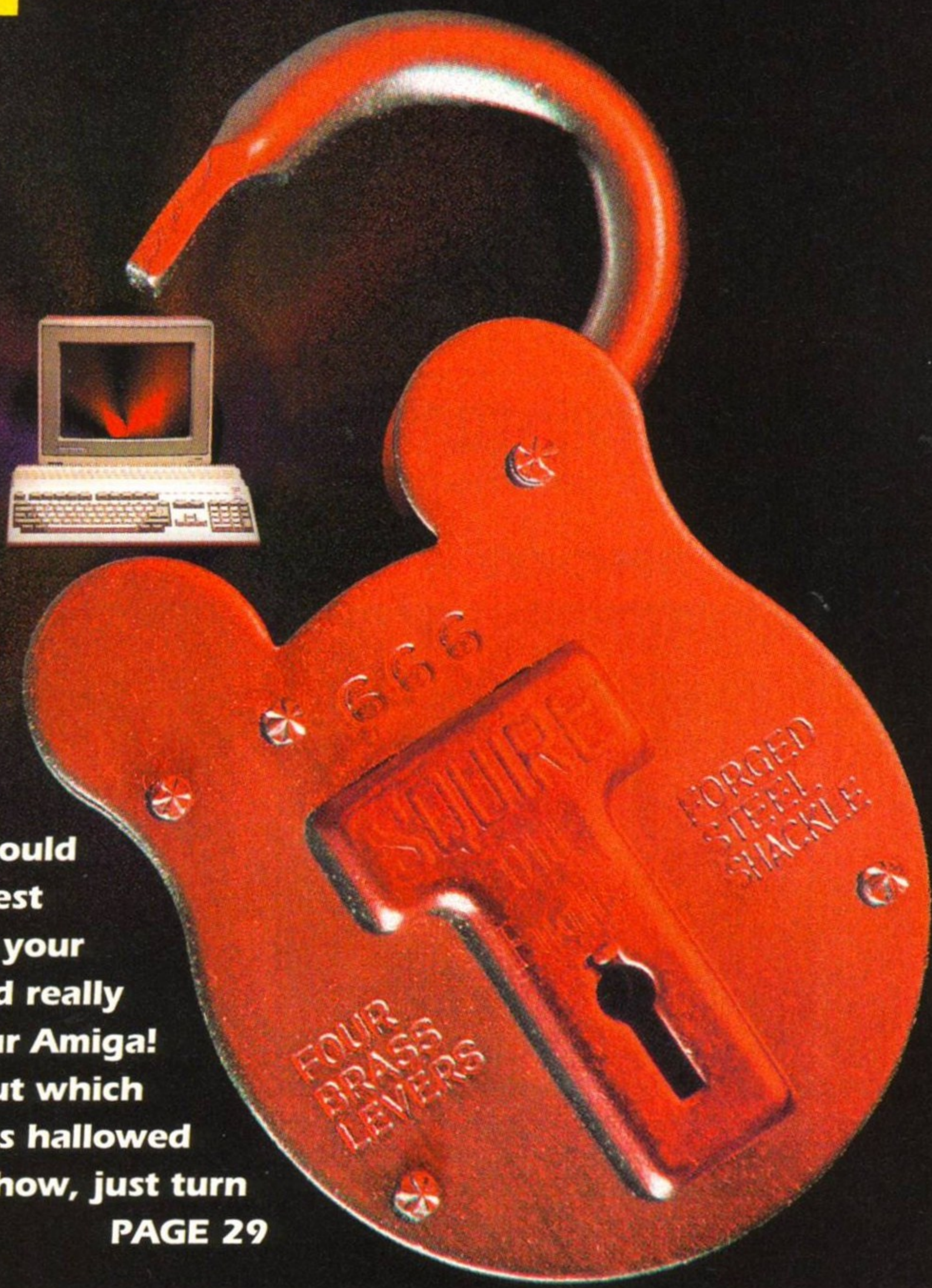

Hard Driving

You can get a lot more pleasure from your computing by doing something as simple as adding a hard drive to your machine. Programs load faster, and you don't have to keep flipping out those floppies. OK, so hard drives aren't cheap, but they aren't as expensive as you might think either. Our indispensable guide to adding storage-power to your Amiga is on...

PAGE 48

Welcome to Amiga Format!

There are a few changes in Amiga Format this month, we'll not bore you with the details, but the upshot is that the photo on the right is of a different person. Me. Hi! I'm Marcus Dyson and I'm the new editor of the mag. If the name sounds familiar it's because I've been art editor of Amiga Format for the last three years. But the slightly uglier picture on the Contents page is about the biggest change you should be able to notice in the mag. Everything else will remain the same, still the same reliable reviews, still the same helpful tips and advice. We'll still be featuring the same opinion-packed Letters pages, and still doing our best to bring you all the news and views from around the Amiga world.

So on to the important stuff, like this month's issue of everyone's favourite Amiga magazine. We've got a big feature on some of the most incredible Amiga software we've ever seen, not your run-of-the-mill stuff, but the really astounding programs that excited

us so much we think everyone should have them. These packages really will let you unlock the power of your Amiga.

Further into the mag there's a feature on hard drives. We take a look at what's so good about them, and why you could hope to benefit from getting one. Then we explain how to get the best buy for your machine, and review a few of the latest hard drive releases.

We also take a look at a couple of exciting new paint packages, both of which can make use of the new screen modes offered by the A1200 and 4000, and work in 256 colours. The first is an update of Electronic Arts' ever-popular Deluxe Paint IV package, the second is a newcomer from the States called Personal Paint. Read on, and enjoy!



Marcus Dyson, editor

ON THIS MONTH'S COVERDISK

AMIGA
FORMAT

Hired Guns

Our best demo ever! Spectacular sci-fi roleplaying from Psygnosis and DMA Design. Don't miss it!

Voltage Controller
DIY hardware project. AMOS example program included.

Bootfix
Now Workbench 1.3 users can store their bootblocks against the virus threat.

Source code to read a four-button joystick

Devpac continued



1 Mb needed • All Amigas • 1 Mb needed

Hired Guns



Possibly our best-ever game demo - take control of a group of futuristic mercenaries in a battle against time (and hordes of nasties of course). Map makers and RPG fans will

love it - and it's the easiest game in the world to control! Full instructions on Page 6

Voltage Controller

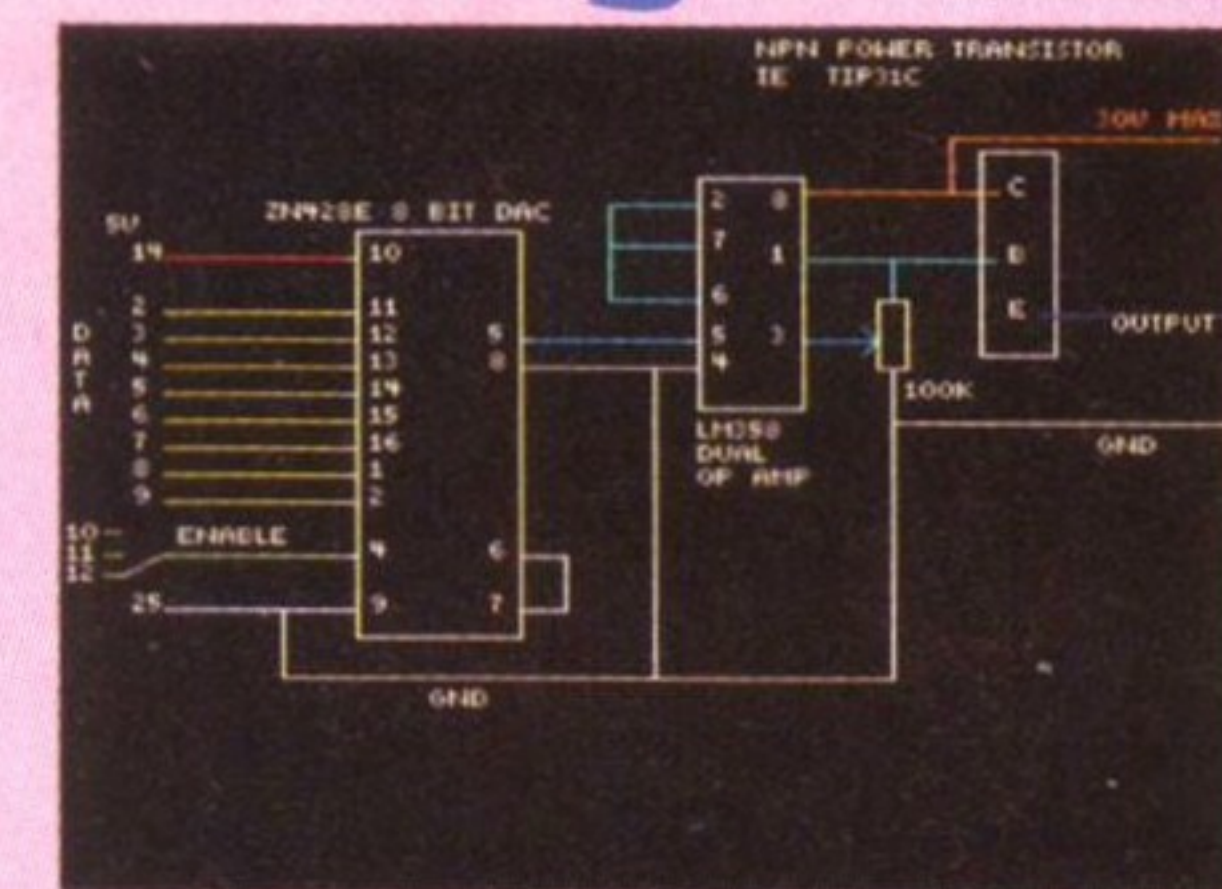

So, you want to drive some external electronics gear, huh? Maybe you've got an information technology qualification to get - this small hardware project could be just

what you're after. Example AMOS code on the Disk, and a parts/price list on Page 190

BootXFix

Hey, you remember that BootX didn't want to work on Kickstart 1.3 machines? This little fix, when run from Workbench, fixes Coverdisk 41b so that the program works fine. More instructions can be found on Page 8

Devpac Continued

Carrying on the Devpac machine code tutorials, here's some example code for reading four-button Sega joypads on any Amiga. Requires some extra hardware (you'll laugh when you see how easy it is to make). One fire-button games not enough? Guidelines for using the code on Page 8

Full Coverdisk instructions on next page...

AMIGA Arcade Issue 44
FORMAT

Hired Guns

Our best demo ever!
Spectacular sci-fi
roleplaying from Psygnosis
and DMA Design. Don't
miss it!

Voltage Controller
DIY hardware project.
AMOS
example program included.

Bootfix
Now Workbench 1.3 users
can store their bootblocks
against the virus threat.

Source code to read a
four-button joystick

Devpac continued



1Mb needed • All Amigas • 1Mb needed

This month we bring you Psygnosis' Hired Guns demo on the Coverdisk. Some say it's the best demo we've ever had, but you can make your own minds up about that, with a little help from these instructions... brought to you by **Pat McDonald**.

Hired Guns

DMA Design/Psygnosis ■ All Amigas

GETTING STARTED

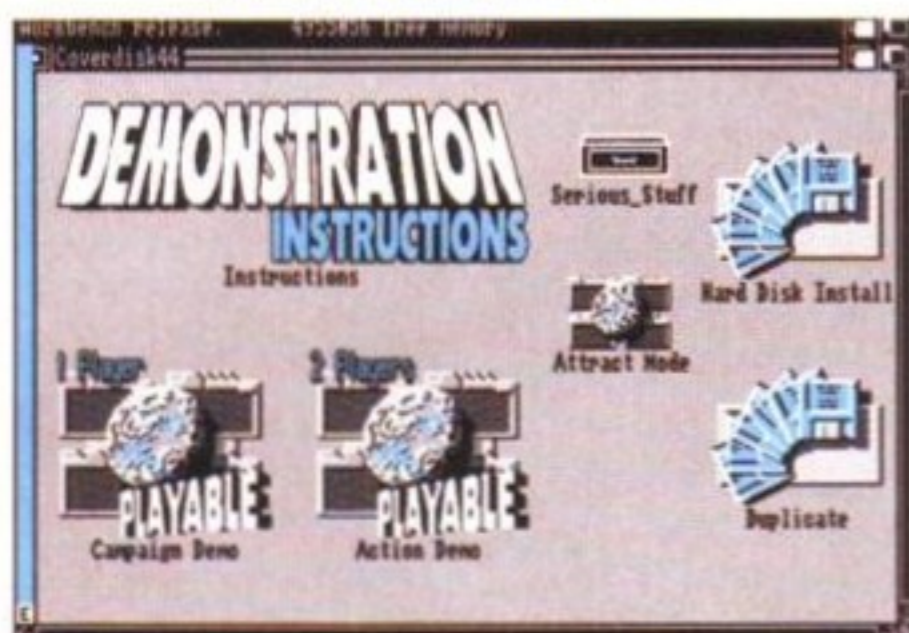

The contents of the Coverdisk, as you should see them. Quite a balanced mix really - have fun!

If you've never used a Coverdisk before, don't worry. This is one of the easiest to use Coverdisks that we've ever had. Simply insert it into any model of Amiga, and eventually a cut-down version of Workbench will load. Move the mouse around - the pointer follows it. Move it to the icon marked 'Coverdisk 44' and double click twice in succession with the left mouse button (do it fast).

A window will open, showing the contents of the disk. Move the mouse pointer again, to one of the icons in the window, and double click with the left mouse button (getting the hang of it yet?). Whatever you just clicked on will start running. The one player, two player and Attract mode icons will all start a version of *Hired Guns*.

To get at the Serious Stuff, you have to double click on the Serious Stuff drawer. Double clicking on any of the icons shown will not run a program - instead, a document or picture will be displayed (as will the Instructions icon you might have noticed). After you've had a browse, either click in the top left hand corner of the screen, or hit the Esc key (in the case of text files).



The *Hired Guns* demo often puts up this message - don't worry, it just takes time to load. Click the left mouse button to continue and be patient.

MOVE & SHOOT - YOU'RE HIT, YOU'RE DEAD!



The key to playing the game is clicking when the mouse pointer is in a certain location. Move it to the left, and it changes to a left arrow. Click and that character will turn left.



When you want your character to move forward, move the mouse pointer to the top of the screen. The pointer changes to a forward arrow - click and that character will move forward.

TAKE CARE OF YOUR EQUIPMENT



The icons at the top of the view window access the back-pack screen. Move the mouse pointer to the equipment that you want to use, and click to move it into the character's hands.



If what you want isn't immediately obvious, you can move up and down the list by moving the pointer to above or below the equipment icons and clicking. The list will move up and down.

KNOW YOUR ENVIRONMENT AND YOURSELF



This is the automap (third top icon). By moving the mouse around, a plan view of a character's surroundings will be displayed. Dead handy when you're drawing your own maps.



This is the most dangerous piece of equipment in the demo. Proximity mines, once activated and dropped, will explode when a character or bad guy walks into it. Handle with care.

ADVANCED TIPS FOR WHEN YOU GET STUCK.

Once you've played a few games of *Hired Guns*, you'll soon realise that, although simple to play, it's a very deep game. Personally, I reckon that it's the best game I've ever seen on the Amiga – but of course we'll have to see the full finished game for an official *Amiga Format* rating.

To go through the doors, move into them – move the mouse pointer to the top of a view and click. The door will open – you have to click again to actually move through, otherwise it will close after a few seconds.

Sometimes, you need a security wafer in order to open certain doors. These can be picked up in the same manner as other items. Don't waste these 'keys'. Sometimes you don't want to use them straight away. When you do use them,

map out the area beyond, and see if you get a real benefit (like getting further into the demo).

Using the lifts is a real puzzle. You have to place one character on the lift, and then use another one to press the activating button – there is usually one within a few squares of each lift. If you've only got one character left alive (all others are MIA – Missing In Action) then I'm afraid you can't use the lifts.

The biggest obstacle in the game is finding your way around. It's really easy to fall down a pit, injuring and isolating one character. Always have a good idea of what's behind you before you move backwards. In the heat of combat though, it's easy to make mistakes! The big grey blocks you encounter can usually be pushed back to

reveal an entrance. Just move the mouse pointer to the middle of a block (it will change to a cross hair) and click. You are best off using your bare hands – don't have an object ready for use or you might waste it. Objects, especially ammunition, are very scarce indeed.

Whatever you do, don't phone me up on a Tuesday to ask me how to complete it. I've played this demo for about five hours solid, and I can still only get to level eight on the one-player version. If you can't get that far, you aren't really trying. I'm sorry, but it's a big demo to be enjoyed, not a five-minute platform wobble. Please, bear in mind all the readers with genuine Amiga problems who really deserve my attention!

Pat McDonald



You should be getting the hang of it now. When you want to turn right, move the mouse pointer to the right hand side of the screen. It changes to a right arrow and clicking will turn the character.



The most useful movement is running away, as Monty Python fans know. Move the pointer to the bottom area and click – but watch out that you don't back into a hole in the ground!

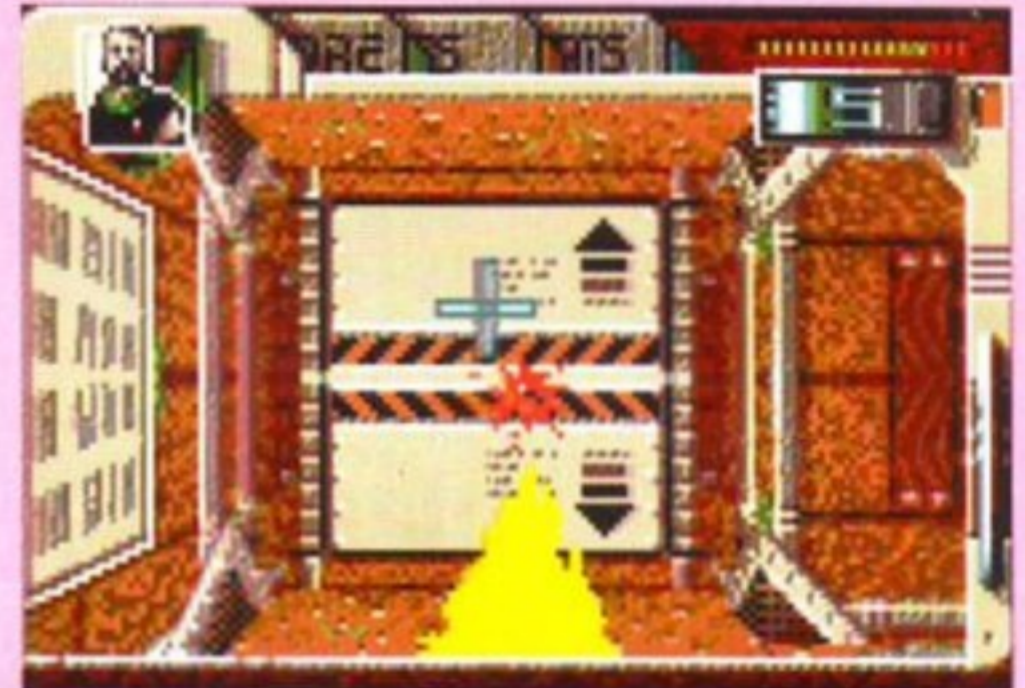

If the mouse pointer is clicked in the middle area (when it's a cross-hair that is) then the character uses what they have in their hands – usually a gun. Take that, you evil mutoid scum!

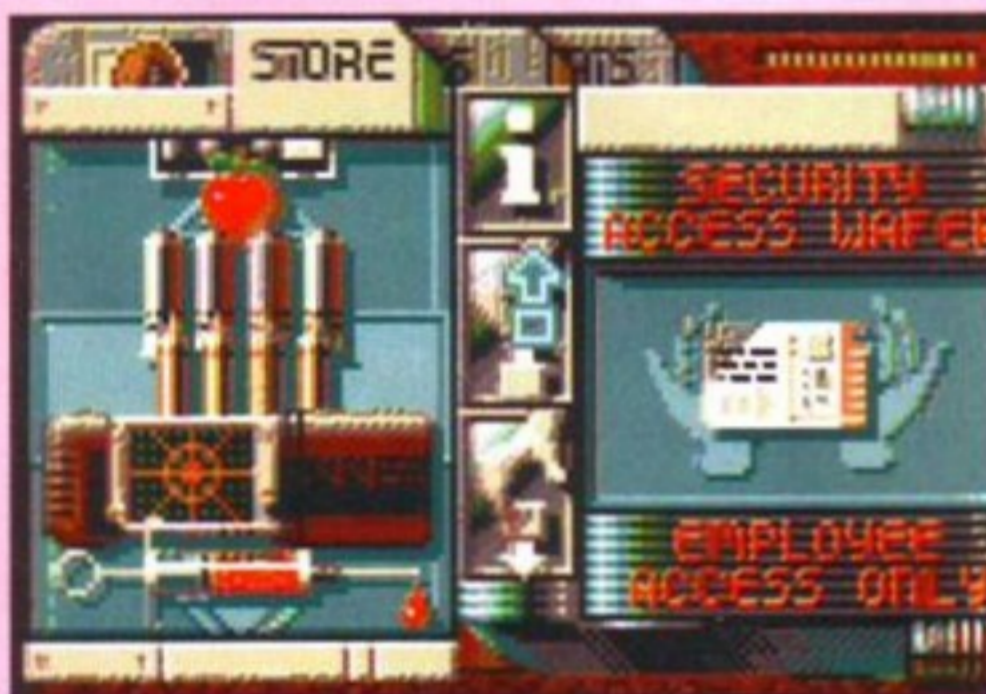

Sometimes, a box appears in the main view. This means you can pick up an item go to the equipment, and move the mouse pointer so it's an up arrow with a box below. Clicking picks up the object.



Dropping the object in the character's hands is very similar. Just move the pointer so it changes to a down arrow with a box above it, and click. It's handy to swap some equipment around the group.



If you click on the I icon, a short description of what it is will be displayed. Note that many objects do not have an information screen – but check each one, as you need all the clues you can get.



The fourth icon at the top of each window displays a character's statistics. If somebody is injured, use a Medikit. Injecting combat drugs before violence occurs can greatly reduce the chance of injury.



This is a view of a character who has just activated a Psi Shied. Psi ratings are displayed on the statistics screen (see left). The higher the rating, the greater a given Psi effect will be.

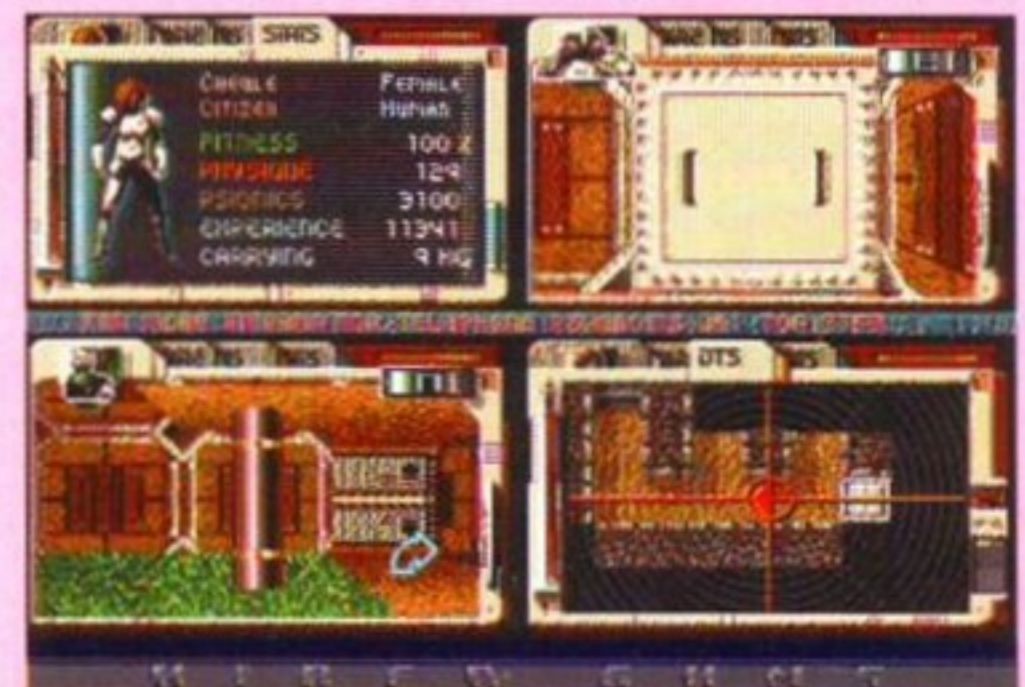

In case you haven't loaded the demo yet, this is what you see – you have to control four characters in the one player demo, or one each in the two-player version. Makes *Eye of the Beholder 2* look a bit tame!

Devpac Continued

ANTHONY BALL AND ED BAMBER
SOURCE ONLY

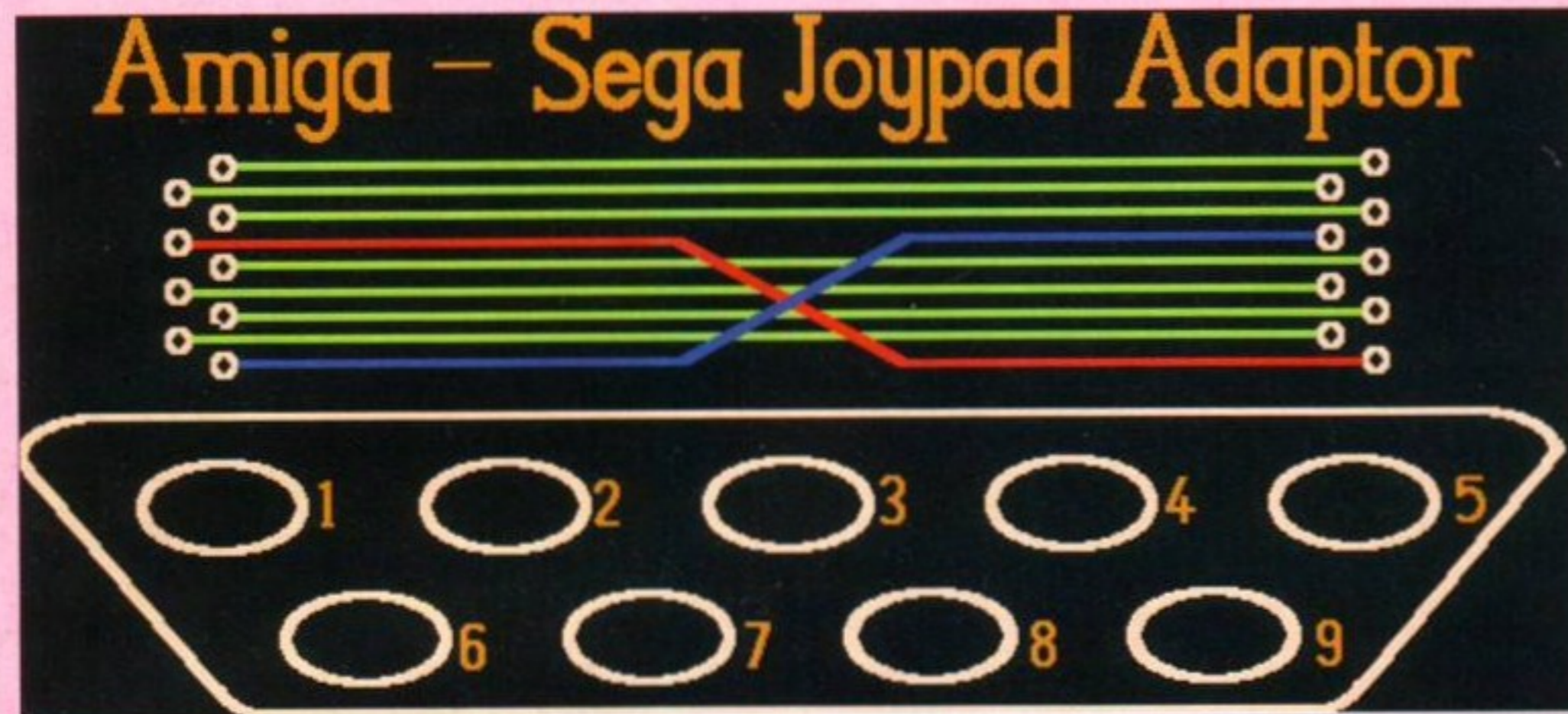

Here's a rough idea of how to make a Sega-Amiga joypad adaptor. Pins 5 and 7 need to be swapped. You need two 9-way D-type connectors - one male to plug the joypad into, and the other female to go into the joystick port of your Amiga. Check the pin numbers written on the connectors - they will be there somewhere, usually in very small type.

THE ORIGINAL AMIGA dates from the Golden Age of home computing. Back then, Spectrums and C64s were in, the ST had just been released and you couldn't get an IBM PC flight sim for love nor money. The Atari VCS games console had been out for about five years, and lots of people still bought cartridges for them. In the USA, a bunch of hippies were busy cooking up the Amiga hardware and in the UK Tim King was laying the foundations of AmigaDOS.

Times change. Spectrums and C64s are out, the ST's just been replaced and you can't move for IBM PC flight sims. The VCS is dead - or is it? Actually, most of the joysticks from that era were cloned from the Atari VCS games console design - which means the Amiga's one-button joystick design is a wee bit out of date by today's games console standards.

All is not lost. By fitting an adaptor to an Amiga joystick port, you can read Sega joypads with an

Amiga. That means you can have three fire-buttons and one start button - effectively a four button joystick. This is especially useful in platform games, beloved of Sega and many Amiga owners alike.

Get one thing straight - unless you're a hacker, you can't do this with an existing game. However, if you are a machine code programmer, then you should find some source code, called *Sega.S*, in the *Serious_Stuff* drawer on this month's Coverdisk. If you use it, please credit the authors in some way on the loading screen, title screen or on the box.

Here's a description of how it works. As well as reading standard one-button digital joysticks, the Amiga can also read analogue (proportional) joysticks. A little know fact is that, as well as reading them, it can also output different resistances. The two hardware registers used for this are called Potgo (a timer that takes on

vertical blank to update) and PotInp (which is used to control the input/output of the joystick port).

The idea behind the code is that you call it every vertical blank - the value returned in the D0 register is what the joystick is reading as for that blank. The top four bits are used for the direction, and the bottom four bits are used for the buttons. Try loading the *Sega.S* file into *Devpac* - it's explained a little better there.

Now, things aren't perfect, because you do have to build a little adaptor for the joystick port. This takes all the wires from your joystick, and plonks them straight into the computer - with the exception of pins 5 and 7. These have to be swapped around. The cost of the adaptor is minimal - I would expect to see them on sale in shops for £5 tops, as they cost less than £2 to make. Ideally, it would be bundled with commercial games as a standard item (possibly with a built-in dongle).

Finally, a word on ethics. It's very silly and a bit cruel to write a game that will only use a Sega joypad. Every single Amiga has got a keyboard with lots and lots of keys on it - so if your game uses lots of controls, leave a keyboard control option in for the people that don't have a Sega joypad.

Ideally, all games should be usable with a standard one-button joystick. But soon, we may not have a lot of choice in the matter. The days of the Atari VCS are long gone. The Amiga (which uses the same joystick system) has to adapt or face the same fate as a mainstream games machine.

VOLTAGE CONTROLLER?

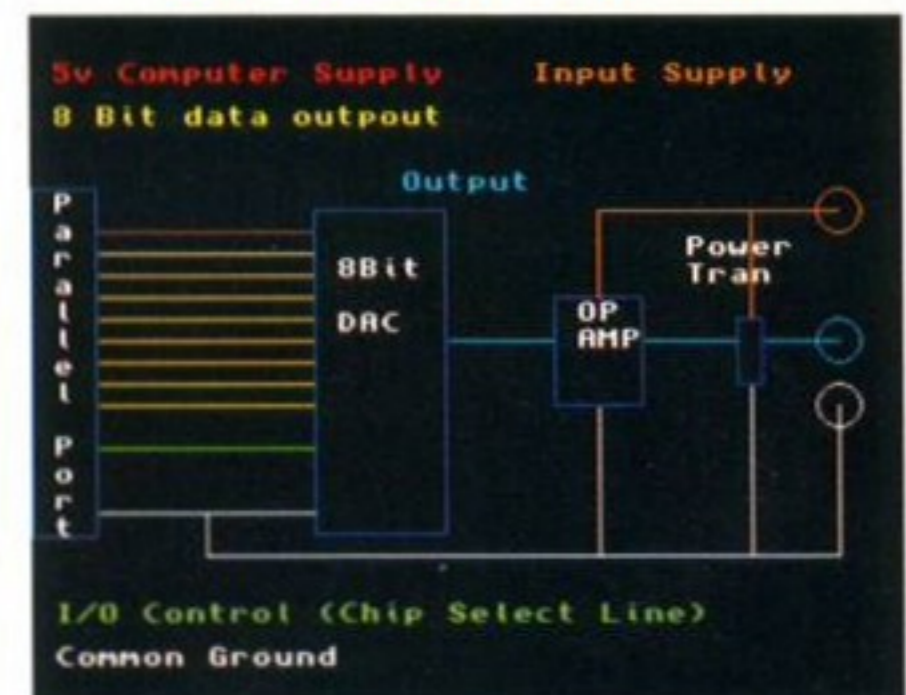

If you want to build one of these, then stop looking at this page and turn to Page 198 instead.

If you're looking for some information on the Voltage Controller circuit, then you're looking on the wrong page. You didn't want to do it like this. Oh no you don't!

Turn to Page 198 for a full low down on what Stuart Taverner is on about, and how to build a voltage controller. Oh yes you do!

BootXFix

BEN MATTHEW
WORKBENCH 1.3

You remember BootX 4.5, from Coverdisk 41b? That particular version wouldn't work on 1.3 machines. This handy fix (which takes about ten minutes) will change a copy of that disk, so that the program works with Kickstart 1.3 machines. As it's a very useful program, for backing up your games' bootblocks, this guy thought a fix would be a good idea. And we had to agree.

First, make a copy of Coverdisk41b. Make sure the copy is write enabled - you can't see through the hole in the corner of the disk. If you can see through the hole, move the tab so that you can't. Unless you do this, the disk cannot be written on

o - and the fix alters the disk.

Right, next boot up with a copy of Workbench 1.3. Once that has loaded, take out the Workbench disk and put in the Coverdisk from this month's issue. Double click with the left mouse button on the Coverdisk icon, again on the *Serious_Stuff* drawer, and again on the *BootXFix* icon.

You will now be asked to swap between Workbench and this month's Coverdisk. This can drive you crazy, so take a deep breath. Be patient and cool. Always wait for the floppy drive light on the front of your Amiga to go out before swapping disks. The Amiga will ask you for each disk - don't try to pre-empt it.

Eventually, the machine will ask for Coverdisk41b, the disk with BootX on it. Put in your copy of that disk, and after a few more disk swaps, the disk will be ready to use.



This is one of the best virus killers around, as well as being able to backup game boot blocks. No Amiga owner should be without it!

DARKMERE



THE NIGHTMARE IS ABOUT TO BEGIN

CORE
DESIGN LIMITED

Using Your Coverdisk

1. Always write-protect your Coverdisk. Move the tab so a hole is showing.
2. Copy the Coverdisk and use the copy, not the original. This may sound like a complicated task, suitable only for techno buffs, but it's surprisingly simple to do, just follow the simple instructions for copying the disk which are given below.
3. Read the instructions when using the programs.

Backing up your Disk

There are two ways of making a copy of your disk, and this is the easy one. Don't be daunted by the fact that you need to use the Shell or CLI: it's actually a lot easier than you might think. Just follow these simple steps...



1 Load your Workbench disk. Open the disk, find the icon that says Shell or CLI and double-click on it.

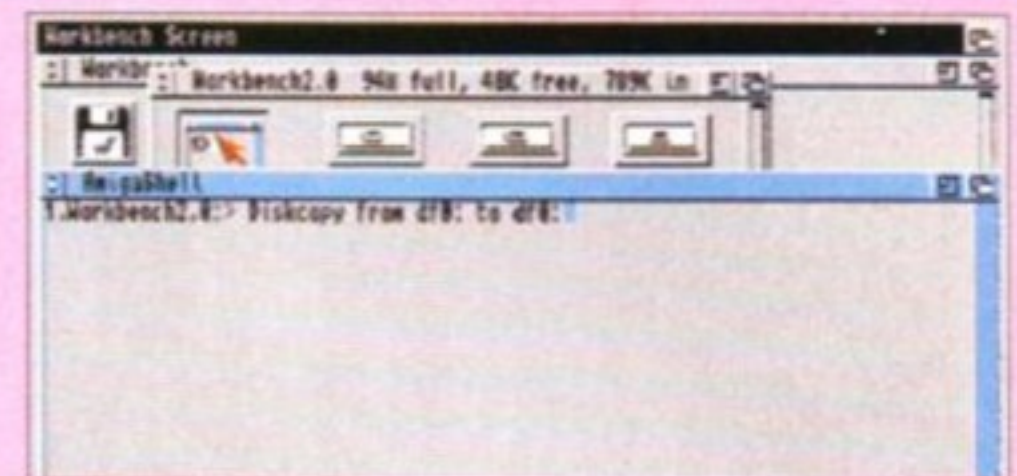

2 When the Shell window appears and the drive light is out, type in:

Diskcopy from DF0: to DF0:
and press the Return key.

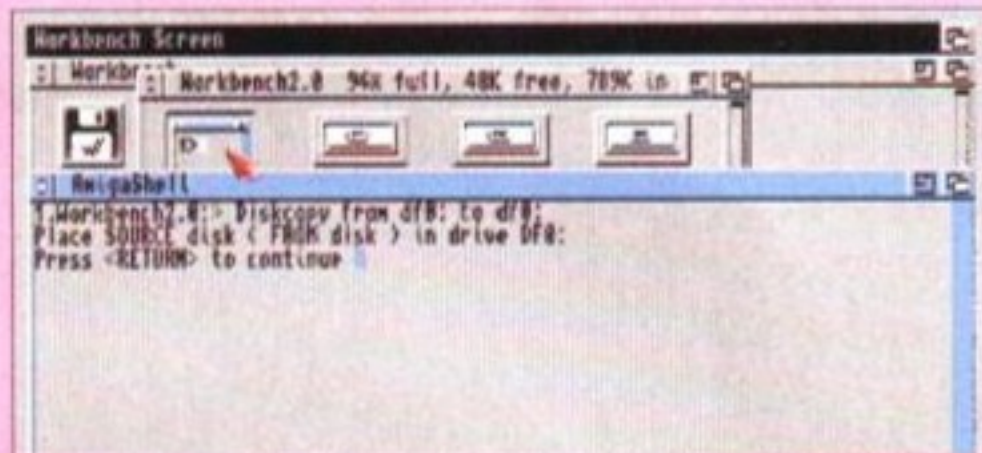

3. The Amiga will now ask you to insert the 'source' disk. It means the disk you want to copy, so put the Coverdisk in the drive and press the Return key.

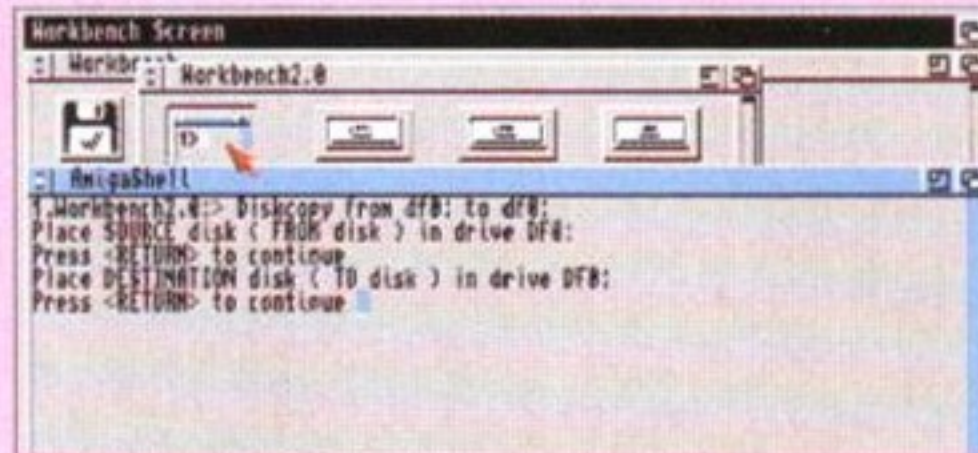

4. Wait for a while and it will read all the information off the Coverdisk, telling you how far it has got. Then it will ask you to insert the 'Destination' disk. Put the disk you want to copy your Coverdisk on to in the drive and press the Return key. Note that the disk does not need to be formatted already.

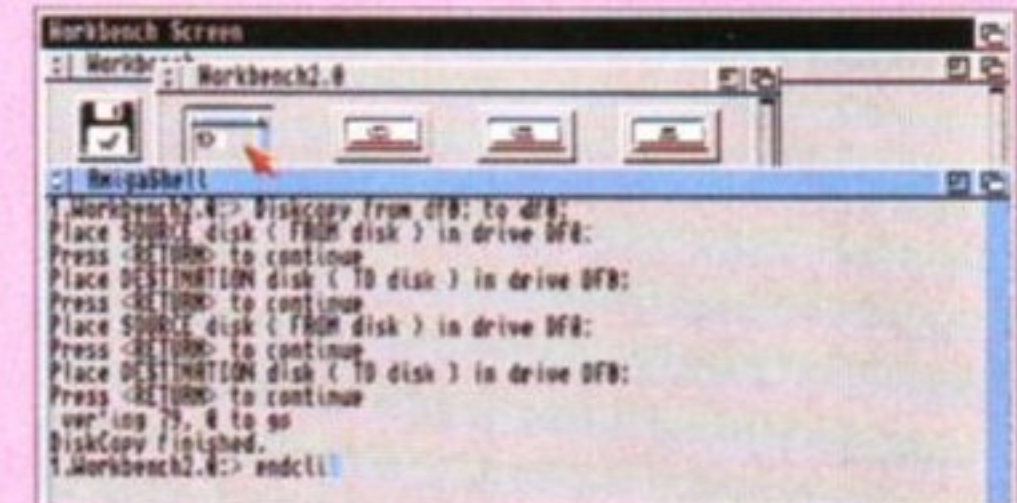

5. Put the source disk and destination disk in a couple more times when the Amiga asks for them. When it says "Diskcopy Finished" just type in:

endcli
to get out of the Shell or CLI. You may have to put the Workbench disk in again. Now your copy is ready!

DISK PROBLEMS?

If you have a problem with the disk – and you're sure the disk is in full working order – then you may need a little help. If you ring us on any Tuesday, and ask to speak to Pat McDonald, he will do his best to help you. Please understand, giving this sort of advice is time-consuming and we are very busy people, so only call if you really have to and do be considerate if we can't talk to you just then. If the problem is particularly complex it is better to send it to us in written detail. It will then be dealt with in the Workbench pages of the magazine.

BE CAREFUL!

We have done our best to check that all of the programs on the **Amiga Format** Coverdisk are simple to use and have no viruses. We cannot usually answer complex telephone queries on the software (see the Disk Problems? box) and we do not accept liability for any consequences of using the numerous programs that are on the disk.

COPYRIGHT

Unless it is specifically stated, the programs on the Coverdisks are not in the Public Domain and the copyright remains with the copyright-holder of the program.

Because some of the programs on the Coverdisks are not PD, selling or distributing them without the copyright-holder's specific permission is against the law.

Disk not working?

We duplicate over 200,000 disks every month. Out of all those, obviously a few will be faulty. If the disk or any of the programs will not load or run properly, there may be a problem. Don't panic!

First try using the *DiskDoctor* utility on your Workbench disk to rescue it before sending it off for a replacement. In-full details of *DiskDoctor* can be found in the user's manual that came with your machine.

However, if your Coverdisk is in fact faulty, you should send it back INCLUDING A STAMPED, ADDRESSED ENVELOPE for a free replacement within one month of the cover date to:

Amiga Format March Disk
Disk Copy Labs Ltd
Units 2&3
Omega Technical Centre
Drayton Fields
Daventry
Northants
NN11 5RT

Ready For Collection

Soccer Stars:

Tackle world class soccer! Go football crazy - football mad - get Soccer Stars!

IBM PC - £25.99
AMIGA - £25.99

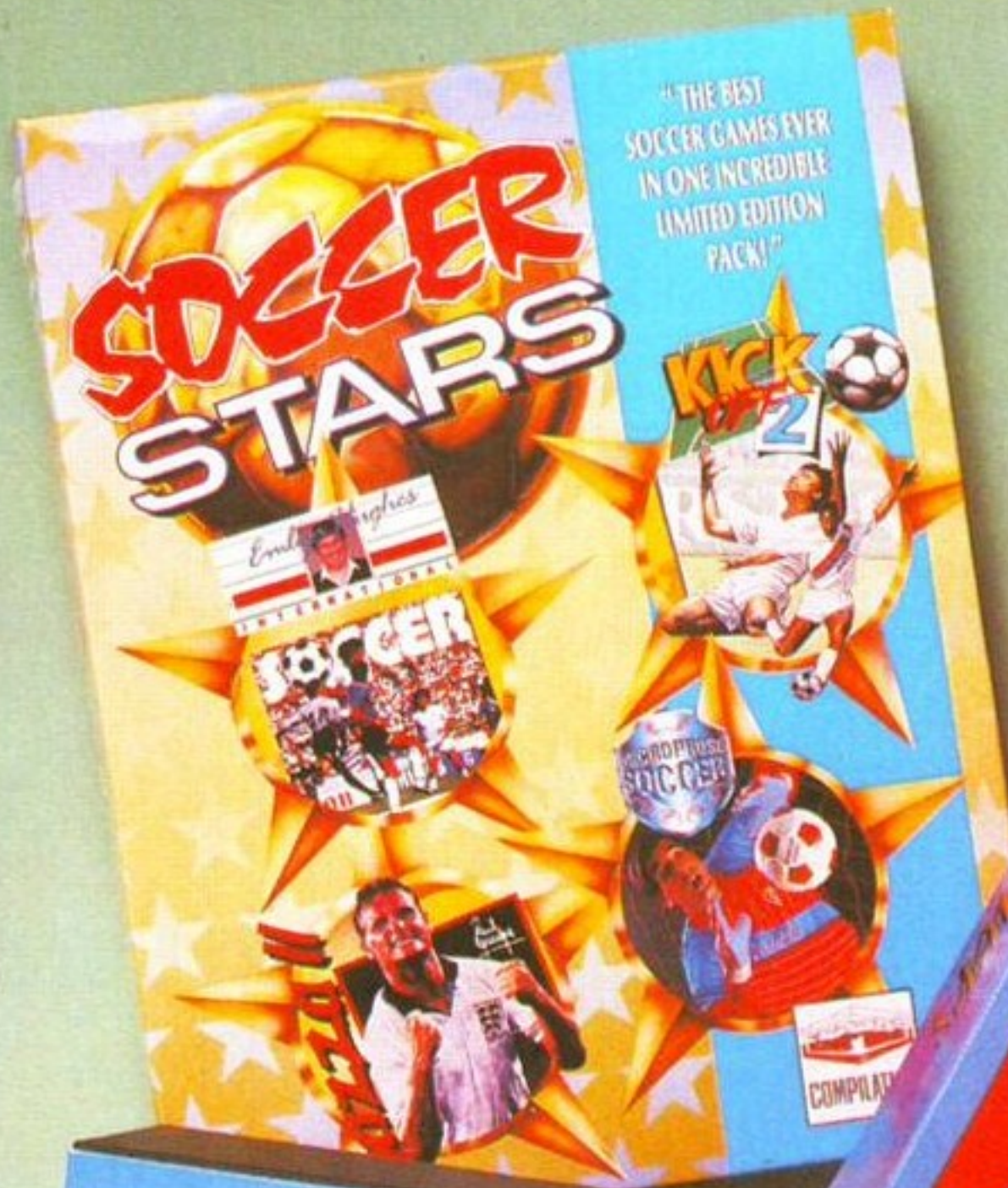

Award Winners:

The definitive games Collection with four chart-topping classics you cannot afford to be without

IBM PC - £29.99
AMIGA - £25.99

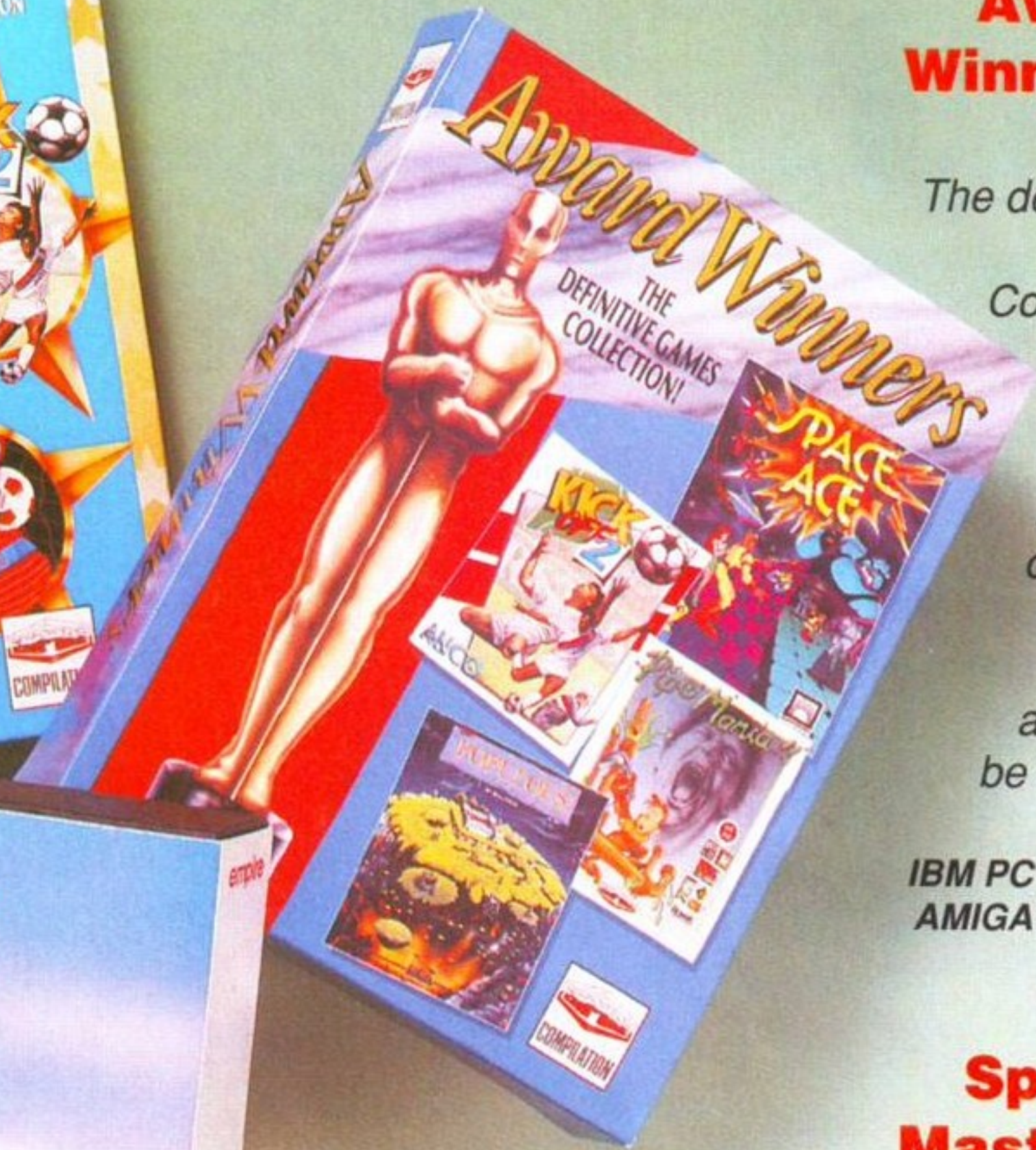

Combat Classics:

Three of the greatest war simulations create the award winning Military Alliance

IBM PC - £34.99
AMIGA - £29.99



F15 STRIKE EAGLE II
688 ATTACK SUB
TEAM YANKEE

Sports Masters:

Experience the challenging world of sports! Team up with four sporting all-time greats!

IBM PC - £34.99
AMIGA - £29.99



Four superb Value Compilation Packs

The essential purchase!

empire
SOFTWARE

AT ECU, WE TAKE YOUR GAME PLAYING SERIOUSLY

TITLE	PUBLISHER	PRICE
3D CONSTRUCTION KIT 2	DOMARK	32.99
4D SPORTS BOXING	CLASSIC	11.99
AIR SUPPORT	PSYGOSIS	16.99
ALIEN BREED SPECIAL ED	TEAM 17	9.99
AQUATIC GAMES	MILLENNIUM	16.99
ARCHER MACLEANS POOL	VIRGIN	16.99
ASSASSIN	TEAM 17	19.99
AV8B HARRIER	DOMARK	23.99
BANE OF COSMIC FORGE	US GOLD	25.50
BAT 2	UBI SOFT	23.99
BATTLECHESS	STAR PERFORMERS	9.99
BATTLE ISLE	UBI SOFT	19.99
BATTLE ISLE ADD-ON	UBI SOFT	14.99
BATTLE OF BRITAIN	LUCASFILM	19.99
B C KID	UBI SOFT	16.99
BEAST 3	PSYGNOSIS	19.99
BIG RUN	STORM	5.99
BILLS TOMATO GAME	PSYGNOSIS	19.99
BODY BLOWS	TEAM 17	17.99
CAMPAIGN	EMPIRE	22.99
CIVILIZATION	MICROPROSE	23.99
COMBAT AIR PATROL	PSYGNOSIS	19.99
COOL WORLD	OCEAN	16.99
COVERT ACTION	MICROPROSE	22.99
CRAZY CARS 3	TITUS	15.99
CRUSADERS OF THE DARK SAVANT	SSI	29.99
CRYSTAL KINGDOM DIZZY	CODEMASTERS	14.99
CURSE OF ENCHANTIA	CORE	22.99
CYTRON	PSYGNOSIS	19.99
D/GENERATION	CLASSIC	11.99
DARKMERE	CORE	23.99
DOODLE BUG	CORE	16.99
DOUBLE DRAGON 3	STORM	7.99
DRAGON'S BREATH	GBH	8.99
DUNE	VIRGIN	19.99
DUNGEON MASTER/CHAOS	PSYGNOSIS	19.99
DYNABLASTERS	UBI SOFT	19.99
EPIC	OCEAN	19.99
EYE OF THE BEHOLDER 2	US GOLD	23.99
EYE OF THE BEHOLDER	US GOLD	15.99
F16 COMBAT PILOT	ACTION 16	8.99
FALCON	ACTION 16	11.99
FIRE AND ICE	RENEGADE	16.99
FIRE FORCE	ICE	13.99
FORMULA ONE GP	MICROPROSE	22.99
GOBLIINS	DREAM FACTORY	16.99
GRAHAM TAYLORS FOOTBALL	KRISALIS	16.99
GUNSHIP 2000	MICROPROSE	23.99
HUMANS	MIRAGE	15.99
INDY JONES FATE OF ATLANTIS	US GOLD	25.50
INDY HEAT	STORM	5.99
INTL RUGBY CHALLENGE	DOMARK	16.99
ISHAR	SILMARILS	13.99
JACK NICKLAUS GOLF	HIT SQUAD	6.99
JAGUAR XJ220	CORE	16.99
JOHN MADDENS FOOTBALL	ELECTRONIC ARTS	16.99
KGB	VIRGIN	19.99
KINGS QUEST V	SIERRA	25.99
LEGEND OF KYRIANDIA	VIRGIN GAMES	19.99
LEGENDS OF VALOUR	US GOLD	26.50
LEMMINGS 2	PSYGNOSIS	19.99
LEMMINGS DOUBLE PACK	PSYGNOSIS	19.99
LETHAL WEAPON 3	OCEAN	14.99
LINKS	US GOLD	24.50
LINKS COURSES DISKS	US GOLD	12.99
LOTUS 3 ULTIMATE CHALL	GREMLIN	14.99
LURE OF THE TEMPTRESS	VIRGIN	19.99



THIS IS THE FRONT COVER TO THE EUROPEAN COMPUTER USER MAGAZINE. FULL DETAILS OF ST, AMIGA AND PC RELEASES, COMMENTARY BY EXPERTS AND NO FAKE SCORES. FOR YOUR COMPLIMENTARY COPY, CALL US TODAY (NO PURCHASE NECESSARY)



europa
computer user

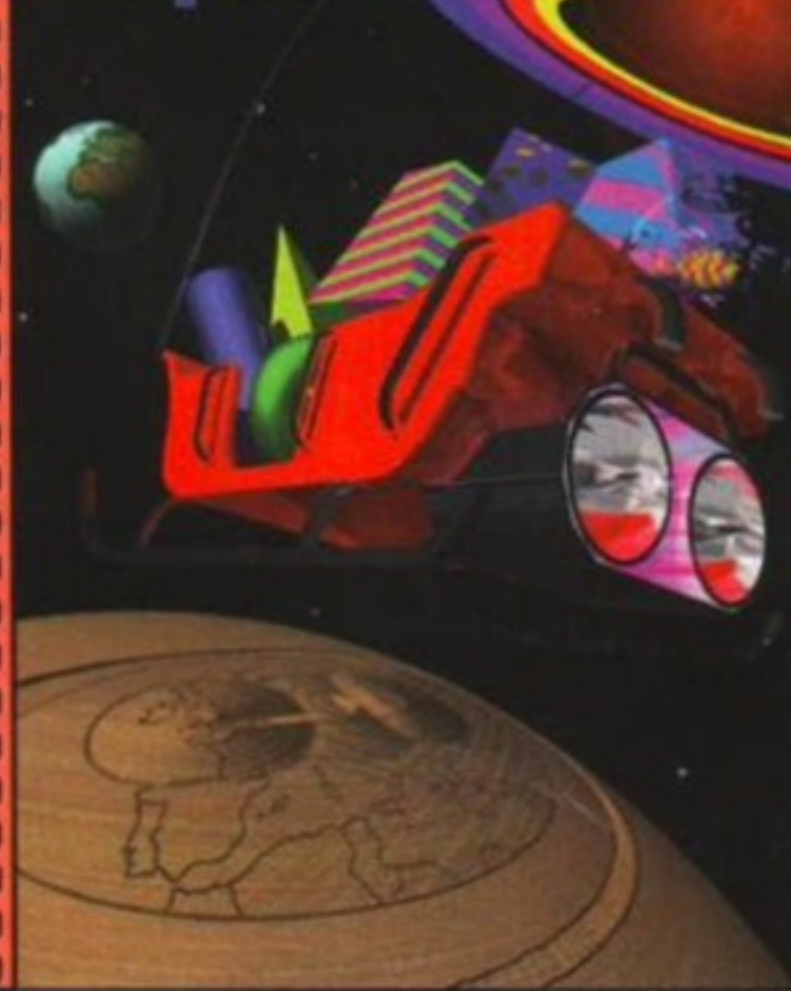

TITLE	PUBLISHER	PRICE
M1 TANK PLATOON	MICROPROSE	19.99
MERCENARY 3	NOVAGEN	9.99
MIGHT & MAGIC 3	SSI	23.99
MONKEY ISLAND 2	US GOLD	25.50
MOTORHEAD	VIRGIN GAMES	12.99
MYTH	SYSTEM 3	9.99
NICK FALDO'S GOLF	GRANDSLAM	23.99
N. MANSELLS WORLD CHAMP	GREMLIN	19.99
NODDY'S PLAYTIME	JUMPING BEAN	16.99
NORTH AND SOUTH	ACTION 16	6.99
PARASOL STARS	OCEAN	16.99
PINBALL DREAMS	21ST CENTURY	16.99
PINBALL FANTASIES	21ST CENTURY	19.99
POPULOUS 2+	ELECTRONIC ARTS	23.99
POPULOUS 2 DATA DISK	ELECTRONIC ARTS	11.99
POPULOUS	STAR PERFORMERS	9.99
PREMIERE	CORE	19.99
PREMIER MANAGER	GREMLIN	16.99
PROJECT X (1 MEG)	TEAM 17	16.99
PUTTY	SYSTEM 3	16.99
REACH FOR THE SKIES (1 MEG)	VIRGIN GAMES	19.99
ROAD RASH	ELECTRONIC ARTS	16.99
ROBOSPORTS	OCEAN	19.99
SABRE TEAM	KRISALIS	16.99
SECRET OF MONKEY ISLAND	US GOLD	16.99
SENSIBLE SOCCER	RENEGADE	16.99
SHADOWWORLDS	KRISALIS	16.99
SHOOT EM UP CONS KIT	PALACE	6.99
SHUTTLE	VIRGIN	19.99
SLEEPWALKER	OCEAN	16.99
SPACE QUEST IV	SIERRA	24.99
STREETFIGHTER 2	US GOLD	17.99
SUPER FROG	TEAM 17	19.99
SUPER HERO	PSYGNOSIS	19.99
SUPER TETRIS	MICROPROSE	19.99
TEAM YANKEE 2	EMPIRE	19.99
THE CHAOS ENGINE	RENEGADE	19.99
THE PERFECT GENERAL	UBISOFT	21.99
TRODDLERS	STORM	14.99
TV SPORTS BASEBALL	MINDSCAPE	11.99
UNIVERSAL MONSTERS	OCEAN	16.99
WAXWORKS	ACCOLADE	23.99
W/C LEADERBOARD	KIXX	8.99
WING COMMANDER	MINDSCAPE	23.99
WIZ KID	OCEAN	16.99
WWF 2 RAMPAGE	OCEAN	16.99
ZOOL	GREMLIN	16.99
COMPILATIONS		
AWARD WINNERS	POPULOUS/K.O.2/PIPEMANIA/SPACE ACE	16.99
BITMAP BROS VOL 1	XENON/CADAVER/SPEEDBALL 2	16.99
COMBAT CLASSICS	TEAM YANKEE/688 ATTACK SUB/F15 STRIKE EAGLE 2	19.99
DIZZY COLLECTION	FAST FOOD/KIXX SNACK/MAGIC LAND/FANTASY WORLD/TREASURE ISLAND	16.99
DIZZYS EXCELLENT ADVENTURES	SPELLBOUND/PANIC/+3 OTHER DIZZY GAMES	16.99
DOUBLE CONFRONTATION	MEGALOMANIA/FIRST SAMURAI	19.99
DREAM TEAM	T2/WWF/SIMPSONS	16.99
FANTASTIC WORLDS	REALMS/PIRATES/WONDERLAND/TETRIS	23.99
LOST TREASURES OF INFOCOM	INFIDEL/SUSPECT/BALLYHOO/HITCHHIKERS/+16 OTHERS	29.99
MAGIC WORLDS	DRAGONS BREATH/STORM MASTER/CRYSTALS OF ARBOREA	19.99
MEGAMIX	LEANDER/AGONY/ORK	19.99
MEGASPORTS	SUMMER GAMES 1 & 2/CALIFORNIA GAMES/WINTER GAMES/THE GAMES	19.99
POWERPACK 2	IT CAME FROM THE DESERT/BATTLEMASTER/PRED 2/WINGS	19.99
PSYCHOS SOCCER COLLECT	KO2/INT SOCC CHALL/WORLD CHAMP SOCC/MAN U	19.99
RAVING MAD	RODLAND/ROBOCOD/MEGATWINS	16.99
SPORTS MASTERS	PGA TOUR/INDY 500/EURO CHAMP 92/ADVANTAGE TENNIS	19.99
STRATEGY MASTER	DEUTEROS/CHESS PLAY 2/150/POPULOUS/SPIRIT EXCAL/HUNTER	21.50
SUPER ALL STARS	STES THE SLUG/MAGIC LAND DIZZY/CAPT DYNAMO/ROBIN HOOD/CJ IN USA	16.99
SUPER FIGHTER	FINAL FIGHT/WWF/PITFIGHTER	16.99

PHONE HOTLINE: 0480 498889
FAX HOTLINE: 0480 496379

EUROPEAN COMPUTER USER Units A2/A3 Edison Road, St Ives, Huntingdon, Cambs, PE17 4LF. Phone 0480 498889, Fax 0480 496379. Office hours Monday to Friday 9.00am to 6.00pm. Answer machine operates outside office hours. Personal callers welcome. Credit card orders charged only on despatch of games (no surcharge). Allow 5 working days from receipt of order for cheque clearance. Make cheques, postal orders and international money orders (sterling only) payable to EUROPEAN COMPUTER USER. All items featured are SUBJECT TO AVAILABILITY. All prices are subject to change without notice. E & O E. All orders are dealt with immediately provided the goods are in stock at the time of your order being processed. However, we may take up to a maximum of 28 days to deliver from receipt of order, with the exception of overseas orders which make take longer.

POST AND PACKAGING: UK, 75p per item 2nd Class, £1.50 per item 1st Class, £1.80 per item 1st class recorded. EEC £2.75 per item, non EEC £3.75 per item, Express Air mail £4.75 per item.

If you do not wish your details to be added to our database for other direct mail, including regular issues of ECU magazine, please tick the box on the form provided, or tell our staff when you call.

VISA

SOME TITLES MAY NOT BE RELEASED AT THE TIME OF GOING TO PRESS. PLEASE TELEPHONE FOR AVAILABILITY AND A COPY OF OUR FULL TERMS AND CONDITIONS.



NAME _____
ADDRESS _____
POSTCODE _____ PHONE _____
ITEM _____ PRICE _____
ITEM _____ PRICE _____
ITEM _____ PRICE _____
POSTAGE _____
TOTAL _____

Visa/Mastercard/Switch Number: _____
Switch issue No: _____ Card Expiry Date: _____

SIGNATURE: _____
 TICK THIS BOX IF YOU DO NOT WISH TO BE ENTERED ONTO THE ECU DATABASE

Make cheques payable to: European Computer User & send to: Units A2/A3 Edison Rd, ST Ives, Huntingdon, CAMBS PE17 4LF

Chuck too

FOLLOWING ON from the success of the fabulous platformer *Chuck Rock*, Core Design are soon to release the sequel –



Son of Chuck. In the game Chuck Senior has been kidnapped by the evil Brick Jagger, and his newly-born son sets out on a mission to save his dad.

The graphics are drawn in a similar style to the original, but the gameplay has subtle differences. Chuck Junior is armed with a club which is twice the size of his body, and he uses it in different ways to get him through the game – including setting fire to it to get him through the darker levels. But hey, kids, remember not to try this at home. Full review next issue.



Son of Chuck: Chuck Senior is kidnapped by the evil Brick Jagger, so junior sets out to rescue him.

A1200 TV shocker

THE DARLING OF the Amiga community, the recently released 32-bit A1200, was looking distinctly tarnished for a short while earlier on this month.

It appears that some A1200s have been experiencing problems with their TV modulators which has resulted in either mono or just plain corrupt signals being shown on standard TV screens.

Users with specialist Amiga monitors need not worry, but on TV screens, not only do images freakishly distort, but the audio output is also affected by what can only be described as sub-standard modulators.

To our knowledge, many A1200s either produce no sound or volume control, or massively over-the-top output that distorts, thus ruining any usage from the machine.

To add insult to injury, it appeared that Commodore UK's appointed maintenance company, Wang (whose parent company in the US was experiencing financial problems last year), either could not, or would not answer the telephone in response to calls from the public regarding the A1200 difficulties.

Amiga Format called 20 times in one day, and one call rang for more than 100 rings to no reply.

With the A1200 widely perceived as being the last bastion of true computing in the face of the console-toy onslaught, and with 1,000s of people having invested in the A1200, this news was hugely disappointing.

We contacted the managing director of Commodore UK, Kelly Sumner, who assured us that everything was under control. He told us that while there were some faulty A1200s, the majority of them had been caught in Commodore's quality-control net.

But the question remains; with Wang not answering



The A1200: some models with sub-standard modulators slipped through Commodore's net but all is now in-hand.

the phones, who is going to deal with those A1200s that *did* get through the quality-control system?

Sumner told us: "Wang recently moved offices from West London to Birmingham. When they did this, they put in a switching device to transfer calls. Unfortunately, Wang realised after a week or so that this switching device was filling up and dropping calls off the end. Wang obviously could not answer calls because they had been lost on the system. I apologise for the inconvenience".

Kelly informs us that by the time you read this, all service calls will have been honoured.

Classic bargain



An A500Plus is for life, not just for a laugh. It's a classic machine, with massive potential.

the useful word processor, *TransWrite*. With the advent of the 32-bit A1200, the 16-bit A500 Plus might seem like a step back, but nevertheless, if you want a tried and tested Amiga with a good value for money software bundle, Silica's offering is well worth considering.

THE A500 PLUS, one of the all-time classic Amigas is being given a new lease of life by Sidcup-based Silica Systems (081-309 1111).

For £249, that's £50 less than the recommended retail price, you can pick up a limited edition A500 Plus and Cartoon Classics bundle – there's just not many of these old troupers left.

The bundle includes the excellent *Deluxe Paint III*, the compulsive *Lemmings*, the dire *Captain Planet*, the *Amiga Format* Gold rated *Zool*, the trend-setting *Pinball Dreams*, the playsome *Striker*, and

QUOTE OF THE MONTH

"JJC are a new company based in High Wycombe with in excess of 12 years experience in the Commodore market."

First of all, how 'new' can a company be with 12 years of experience? Secondly, how many Commodores are in this market? And can you get a few Admirals too?

Get MIDI meal!

AMIGA MUSICIANS LISTEN up! The 4th Annual MIDI Music Show is on at the Wembley Conference and Exhibition Centre from Friday April 23 to Sunday April 25.

With more than 150 exhibitors expected to attend, the show looks as though it will hold plenty of interest for expert and budding musicians alike.

One interesting element for Amiga users will surely be Garry Mason's demonstration of the use of ROM cards (such as the PCMCIA cards used in the A600 and A1200) for synth programming. For more information on the show and to order tickets (£8 on the door, £4 in advance) call 081-547 1183.

Live now, live later

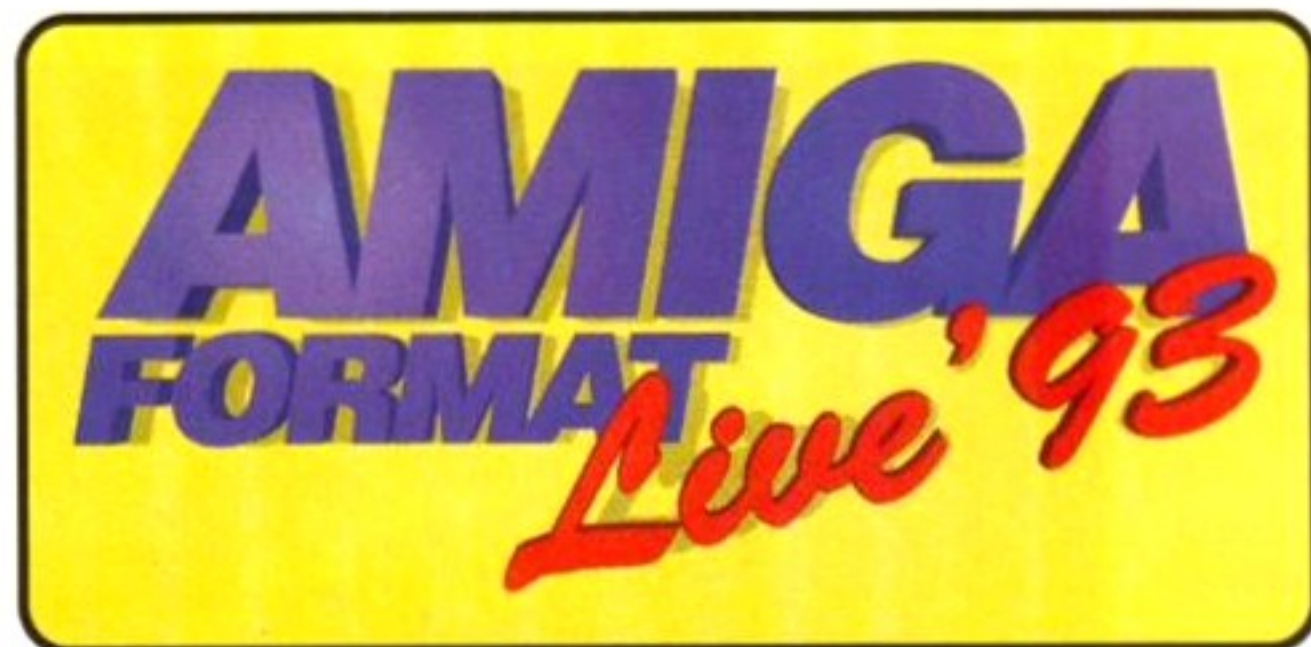

AMIGA FORMAT'S FORAY into live action with the **Amiga Format Live** show (Friday May 7 to Sunday May 9), has really picked up speed this month with exciting news that even Commodore have been wowed by the idea of a single-format show.

Commodore's national marketing manager, Dawn Levack told *Amiga Format*: "We feel that our interests couldn't be in better hands."

Nice to hear, but obviously it's not Commodore's interests that are at the front of our minds. While we are pleased to hear that the company behind the Amiga will be fully

represented, at what should be one of the UK's biggest and most impressive single-format computer shows ever, it is Amiga users (and potential Amiga users) that will really make the *Amiga Format Live* show happen. So don't forget to write to new editor Marcus with ideas for what you want to see and be involved in at the May 7-9 show. Write to My *Amiga Format Live*, *Amiga Format*, 30 Monmouth St, Bath, BA1 2BW. You never know, you might even be lucky (or astute) enough to win some tickets!

ProData update

The **AMIGA** Collection
FORMAT

Prodata

No. 11 RRP £60
FROM ARNOR

Do you realise just how useful a database can be? If not, you soon will, when you start using this powerful complete package!

● All Amigas ● 1Mb Required ● All Amigas ●

IF YOU WERE lucky enough to get the last edition of *Amiga Format*, then you will already be in possession of the excellent *ProData* database that we featured on the Coverdisk (if not, turn to 168 for back issues).

Although we put a fully functioning version of Arnor's incredibly useful program on the Coverdisk, there is still more to come.

If your Amiga has 1Mb of RAM, and you have £30 to spare, you can upgrade to *ProData* 1.2 using the form below (readers in EC countries must stump up £32.50, non-EC residents pay £30).

The upgraded system offers two-across label printing, enhanced file selection, duplicate checking, and automatic record numbering among a host of other features. Arnor are on 0733 68909.

Be a referee in Goal!

FOLLOWING OUR REPORT last month of Dino Dini's signing to Virgin Games, we can inform you that the sequel to *Kick Off 2* is likely to be called *Dino Dini's Goal!*. This is because an existing game is also called *Goal!*, and the name will be changed to avoid confusion.



You could star in the sequel to *Kick Off 2*. See the competition below...

Andy Nuttall, your friendly staff writer, has had an in-depth look at the game, and he can confidently report that it is going to be a massive improvement over *Kick Off 2*. Will the lads at Sensible take this opportunity to develop *Sensible Soccer 2*? We shall see...

COMPETITION TIME!

Virgin Games are offering one lucky Amiga Format reader the chance to be a referee in the sequel to *Kick Off 2*. This is means that you will have your name in what could possibly be the biggest Amiga game ever - just imagine it, millions of computer football games, all played with you as referee! So what do you need to do for this fantastic special prize? Simply answer the following question:

Who refereed in the 1966 World Cup Final?

Answers on a postcard, back of a stuck-down envelope addressed to:
'Ref-Me' Competition, Amiga Format, Future Publishing, Beauford Court, 30 Monmouth St, Bath, AVON, BA1 2BW. Get your entry here by 18 March 1993. Normal competition rules apply.

PRODATA UPGRADE ORDER FORM

Detach and send to Arnor Ltd, 611 Lincoln Rd, Peterborough PE1 3HA.

Please send me my upgrade to Prodata 1.2

Offer ends 30 April

Name _____

I use an Amiga with at least 1Mb memory

Address _____

Payment £30 £32.50

Method of payment: Access Visa Cheque PO

Postcode _____

Card No _____

Phone _____

Expiry Date _____

Special Consideration

FROM THE MAKERS OF THE WORLD'S BEST-SELLING AMIGA MAGAZINE

AMIGA FORMAT SPECIAL

THE
ENCYCLOPAEDIA
OF THE AMIGA

The essential reference work for all Amiga owners
Over 160 pages with more than 2,000 Amiga entries
Researched, written and compiled by Amiga experts
Accurate, informed, up-to-date and fully illustrated



The *Amiga Format Encyclopaedia*: more than 2,000 Amiga facts, figures and points of interest.

How many pages of *Amiga Format* information will there be for you in March? 368, that's how many. That's because the fourth *Amiga Format Special* is due out in the first week of March and it will be a mammoth 164 pages on its own – try binding all of that inside another magazine!

The *Encyclopaedia of the Amiga* contains more than 2,000 Amiga-related facts and figures, and is packed to the gills with exciting colour illustrations. According to *Specials* editor, Tim Smith: "We've been badgering people who have worked with the Amiga since the beginning in order to bring the complete picture to *Amiga Format* readers. I hope this is just the first edition of *The Encyclopaedia* and that we will continue to update it year-by-year. There's so much information out there regarding the Amiga, that my biggest problem is what to leave out!"

The *Encyclopaedia of the Amiga* costs £3.95 and will be on news-stands from early March. Don't miss it.

Down! ARexx

You may not know it, but your Amiga probably comes with one of the most versatile programming languages on any home computer, ARexx is part of Workbench 2 and 3 and is being touted as a replacement for AmigaBASIC. And now there's a sub-industry starting up in order to help you with this wonder language.

One part of this industry comes from Bruce Smith Books (yet another BSB!) with their *Mastering Amiga ARexx*. The 336-page book features tutorials, details of built-in ARexx functions, as well as programming tips and tricks. There is also a disk with various ARexx listings included.

It is written by ARexx expert Paul Overaa and costs £21.95. Contact Bruce Smith Books on 0923 894355.

Delphine back in a Flash

DELPHINE, THE FRENCH software house famous for their smash arcade adventure *Another World* (the game featured in the Commodore Christmas advertising campaign), are set to release their next game in the genre.

Although not strictly a sequel, *Flashback* has a similar look and feel to *Another World*, but Delphine claim that it's six-times larger and features a main character animated at a rate of 24 frames per second – which is the same as most animated movies. To create this effect the animators used a process known as rotoscoping, where they film a real actor going through all the necessary movements, and they then transfer those movements to the Amiga.

Although the game is on the shelves in France, US Gold have not supplied finished versions to any UK magazines as yet. But you can bet as soon as they do, we'll be bringing you the definitive review.



Delphine – the people behind the excellent *Another World* – latest release, *Flashback*, looks just as stunning. See the review next ish.

Stuff and nonsense



Commodore's compact disc forays are being played up and up in the international rumour mill.

take-over bid is highly unlikely, and that the rumours are totally unfounded.

As for a CD-based, low-end Amiga, we know that Commodore UK managing director, Kelly Sumner is a strong advocate of CD technology (see *Amiga Formats* passim) so we see no reason to doubt that such a machine could exist – just read the Future Amiga feature in AF43 and you can see our artist's impression of the beast. But as yet no launch plans for this, or the eagerly awaited A1500/2000 replacement have been announced.

YOU HEARD IT here first... various rumours have been circulating in the international Amiga community concerning Commodore and Panasonic combining on a CD-console project (does anyone remember the ACDC?).

Another element to this rumour is the speculation that not only are Panasonic (who are part of the mammoth Matsushita Electronics empire) working in conjunction with Commodore, but that the Japanese company actually might be thinking of buying out Commodore wholesale. This is unlikely in the extreme.

What we do know, though, is that Panasonic are very interested in the CD-ROM side of computer technology and that they have been working very closely with a number of hardware and software manufacturers worldwide. But then again so have Sony. As far as we have been able to ascertain from sources close to and inside both companies, a

APPLAUSE FOR ADPRO

We said it was good (85 per cent in AF36), and now ASDG's Art Department Professional (or ADPro) has proved it by rating third in MicroPace's list of the Top 50 best-selling Amiga products of 1992. This is an impressive achievement for what many people thought of as just specialist video software. It also proves that this area of Amiga usage is still as popular as ever.

880 into 1200 will go

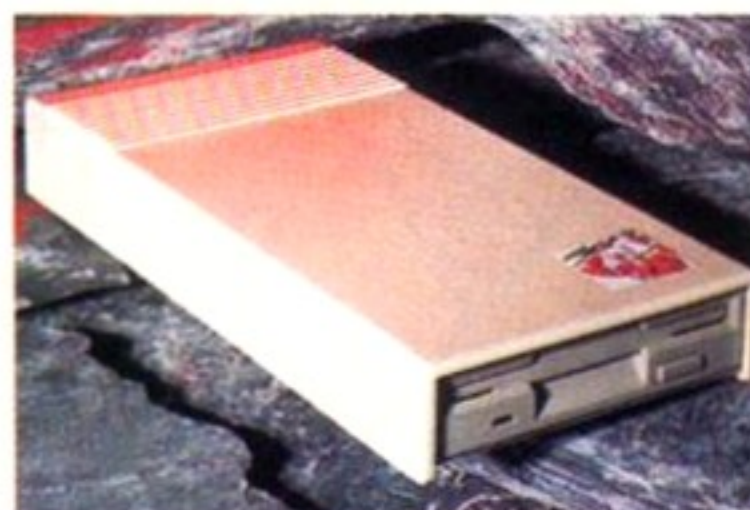

Yet another problem with the A1200 is revealed and then solved.

of £15, including return postage. Just send your drive to Power Computing at Unit 8, Railton Road, Woburn Road Industrial Estate, Kempston, Bedford, MK42 7PN, 0234 843388.

We reported in WorkBench last month that Power Computing's PC880B floppy drive was experiencing some compatibility problems with the A1200. Power have identified the problem, and new drives are now A1200 friendly.

Any owners of drives that are experiencing a problem can get it fixed for the very reasonable price

Action SIXTEEN

CLASSIC
games
PREMIER
prices
SUPREME
value

Original software
at unbeatable
prices

SUPREME

PREMIER

CLASSIC



FALCON
IBM PC, AMIGA,
ST/STE - £14.99



FLIGHT OF THE
INTRUDER
IBM PC, AMIGA,
ST/STE - £14.99



OPERATION
COUNTERSTRIKE
AMIGA, ST/STE - £9.99



TANK
IBM PC - £14.99



OPERATION
FIREFIGHT
AMIGA, ST/STE - £9.99



STUNT DRIVER
IBM PC - £14.99



F-16 COMBAT PILOT
IBM PC, AMIGA,
ST/STE - £9.99



A.D.S.
IBM PC, AMIGA,
ST/STE - £9.99



NORTH & SOUTH
IBM PC, AMIGA,
ST/STE - £7.99

AMIGA
IBM PC
ATARI ST/STE

Send SAE for
FREE catalogue

Available from
leading retail
outlets. In case
of difficulty
phone
0276 684959



A duck called Dong

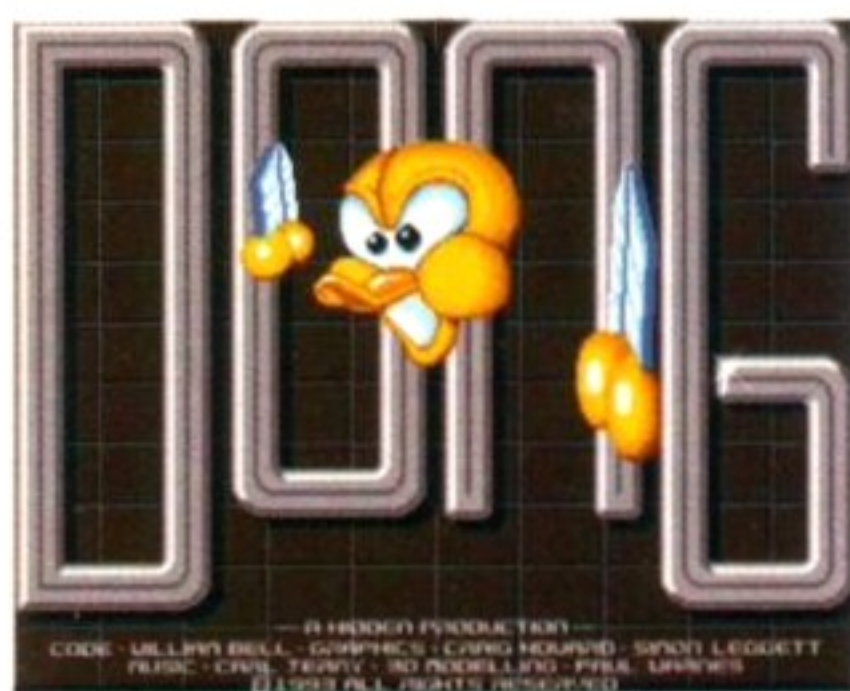

Amiga demo coders are breaking into the mainstream market with the likes of *Dong*.

Dong is a new game from a new team of games programmers and Amiga demo coders, The Hidden. They claim that they are aiming to compete with established programmers such as Team 17.

Although it has dubious name, The Hidden assure us that the sexual references stop at the title.

With some stonking new releases from Team 17 on the cards, The Hidden have quite a job on their hands to achieve their aim, but it's certainly looking good so far. *Amiga Format* readers can decide for themselves next month when we include a playable demo of the game on our cover for you to load at your leisure.

Swedish Hardcore

It's all go from Digital Illusions. They are branching out into the arcade/platform genre with two projects due for completion in September this year. Pictured here is the first, *HardCore*, which looks like a rip-roaring arcade shoot-em-up.

The second, *Ben E Factor*, is a cutesy platformer, which Fredrik says will be similar in style to *Lemmings*. As always, *Amiga Format* will keep you up to date on these games in future issues.

Also from Digital Illusions, the team that created the fantastic *Pinball Dreams* and *Pinball Fantasies*, comes a third pinball game entitled *Pinball Illusions*. According to Digital Illusion's software manager Fredrik Lillégren, the game will be "...the last in the trilogy of smash-hit pinball simulations," and will include loads of new features including multiball.

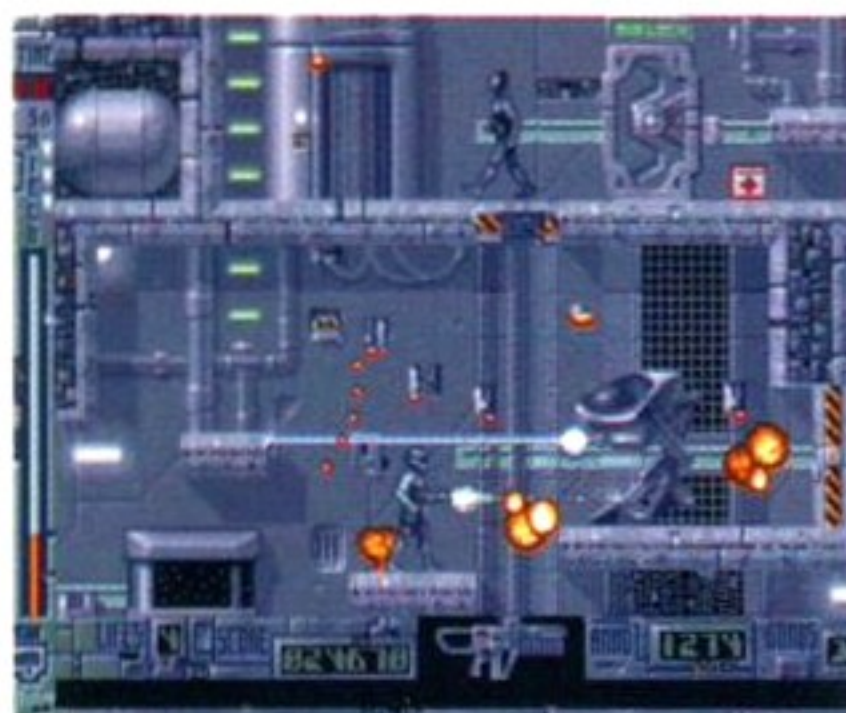

Hardcore, now there's a game name to conjure with. Arcade action from pinball roots.

UK software house 21st Century Entertainment have again got the licence to publish the game.

Team 17's blow to the senses



Team 17's next release is a furious beat-em-up. Is it a *Streetfighter 2* rival.

Challenge or no challenge (see 'A duck called Dong') Team 17 are still beavering away with Amiga games production.

From what we've seen, *Body Blows*, is a very fast, furious beat-em-up inspired by the (incredibly pricey) Neo Geo game *Fatal Fury* and it's the next offering from Yorkshire-based coders Team 17.

From the demo we have seen, the game looks and plays faster than *Streetfighter 2*, so it looks like it's going to be a biggy!

If it's finished in time we will bring you a full review in the next *Amiga Format*, but for the moment look out for it on the coverdisk of our dedicated-to-games sister magazine *Amiga Power*.

The King of Ragnarok 'n' roll!



Mirage's violent answer to chess could be a *Battle Chess* beater.

Coming soon from Mirage, creators of *The Humans*, is *The Legend of Ragnarok*, a game based on an ancient European board-game *The King's Table*. The game sees two teams trying to outwit each other.

The good team is positioned all around the edges of the board, while the evil team is in the centre. The evil side must try to get its king to one of the corners of the board, while the good side tries to capture all the enemy pieces. Similar to *Battle Chess*, the game contains some gory scenes where pieces take one another using various sharp implements, and music plays to add to the atmosphere. Look out for a full review in next month's *Amiga Format*.

This month's top 30



Rank	Change	Game	Score
1	(-)	New <i>Streetfighter 2</i> US Gold	87%
2	(2)	■ <i>Sensible Soccer 92/93</i> Renegade/Mindscape	80%
3	(-)	New <i>Wing Commander</i> Mindscape	83%
4	(1)	▼ <i>Zool</i> Gremlin Graphics	95%
5	(9)	▲ <i>Premier Manager</i> Gremlin Graphics	87%
6	(26)	▲ <i>Indiana Jones - Fate of Atlantis</i> US Gold	FG92%
7	(14)	▲ <i>AV8B Harrier Assault</i> Domark	60%
8	(7)	▼ <i>WWF European Rampage Tour</i> Ocean	18%
9	(4)	▼ <i>Road Rash</i> Electronic Arts	84%
10	(12)	▲ <i>Campaign</i> Empire	79%
11	(22)	▲ <i>PGA Tour +</i> Electronic Arts	Comp
12	(3)	▼ <i>Archer MacLean's Pool</i> Virgin	89%
13	(5)	▼ <i>Pinball Fantasies</i> 21st Century	FG90%
14	(19)	▲ <i>Formula One Grand Prix</i> MicroProse	FG92%
15	(8)	▼ <i>Humans</i> Mirage	72%
16	(11)	▼ <i>Monkey Island 2</i> US Gold	FG95%
17	(15)	▼ <i>Jimmy White's Whirlwind Snooker</i> Virgin Games	FG91%
18	(17)	▼ <i>Civilization</i> MicroProse	FG94%
19	(6)	▼ <i>Putty</i> System 3	FG95%
20	(-)	New <i>Dr Who - Dalek Attack</i> Alternative	59%
21	(18)	▼ <i>Fire and Ice</i> Renegade/Mindscape	89%
22	(13)	▼ <i>Lotus 3: The Ultimate Challenge</i> Gremlin Graphics	76%
23	(-)	New <i>John Madden American Football</i> Electronic Arts	FG94%
24	(10)	▼ <i>Nigel Mansell</i> Gremlin Graphics	55%
25	(20)	▼ <i>Assassin</i> Team 17	85%
26	(-)	New <i>Mini Office</i> Europress Software	84%
27	(-)	New <i>Ultima V</i> Origin/Mindscape	67%
28	(-)	New <i>Sim Earth</i> Ocean	79%
29	(21)	▼ <i>Curse of Enchantia</i> Core Design	62%
30	(-)	New <i>Lemmings</i> Psygnosis	92%

Opal fruits



IF YOU'VE GOT the fabulous OpalVision, and you want to upgrade it, but can't be doing with all the bother of contacting Centaur in the States, you'll be pleased to hear that EM Computergraphic of Clacton-on-Sea have secured the rights to distribute the two upgrade disks in the UK. These disks include OpalPaint 1.4, OpalPresents 1.2, OpalHotkey 1.4, OpalAnimUtils 1.4, OpalLibrary 3.1 and the ADPro display module. The disks cost £5.99.

For more information call EMC on 0255 431389.

Now you can upgrade the fabulous *OpalVision* without having to contact the States – just get to Clacton-on-Sea!

Attic Attack



Now madam consider carefully, do you recognise any of these people at all. Just take your time and point to the face...

"These are legendary Germans, and they come in a new game from the *Realms of Arkania* series." Thank you madam.

GERMAN CODERS ATTIC software are to produce their best-selling PC role-playing game *Blade of Destiny* for the Amiga.

The first game of the promising *Realms of Arkania* series, *Blade of Destiny* boasts over 400 hours of gameplay and a wide variety of sub-games which will 'add colour and excitement to the adventure.' Hmmm?

Well we've been reliably informed that the game has already sold 15,000 copies in Germany alone, and it's due for release in March/April this year. Of course, we will bring you a full review in the next issue.

Also in the role-playing-game genre, International Computer Entertainment are soon to release *Abandoned Places 2*, the aptly named sequel to the best-selling *Abandoned Places*.

In a similar style to the classic SSI dungeon exploration game *Eye of the Beholder 2*, *Abandoned Places 2* features customised spells, 64-colour graphics, 32 large and varied levels, and over 25 different characters.

It certainly sounds impressive enough to be going on with, and we are all eagerly awaiting a half-decent new adventure game!

Futureworld and Dynamite Computers cease trading

AS FAR AS we are aware, two computer retail outlets, Futureworld and Dynamite Computers have ceased trading as of late January.

The good news for people who have ordered goods from these two companies is that, to our knowledge, orders made will be honoured by both companies.

With the knowledge that the recession is still claiming victims, firmly at the front of our minds, the April issue of *Amiga Format* will include an in-depth article with tips and hints to wise and sensible buying. Don't miss it.

Hale the pace

LIFE FOR A1200 owners just seems to get better and better this month.

The latest good news is that Micropace are offering you the chance to jet away from RAM and speed problems – thus making even more use of the A1200's 32-bit technology – with the MBX1200 RAM upgrade/accelerator board. The MBX 1200 comes with up to 8Mb of 32-bit SIMM (single in-line memory module) RAM on-board in unison with a Motorola 68881/8882 FPU (floating point unit) math co-processor.

Prices for the speedy unit start at £149.95 and rise to £389.90 depending on the amount of RAM and the type of copper you require. For more information call MicroPace on 0753 551888.

The games real men play

ARE WE MORE war-literate because of computer games? At *Amiga Format* we reckon given the recent re-emergence of the Gulf War, that sales of war-games must be rising. So we asked two top software houses their opinions regarding the link between military simulations and real-life war, and whether the Gulf war will affect the release of their games.

YVETTE WEIR OF MICROPROSE
GUNSHIP 2000, B-17...

"MicroProse have been producing games for over 10 years. In the past five years we have included Persian Gulf scenarios, and so we can not be accused of cashing in on the hype of a war.

"Our games are simulations of aircrafts, not wars. However, we anticipate a slight increase in sales due to the recent activities in the Gulf."

SIMON JEFFERY
OF ELECTRONIC ARTS
DESERT STRIKE...

"The Amiga version (of *Desert Strike*) is not ready yet. We will have to sit down and assess the current situation in the Gulf as and when it is ready. We certainly haven't seen any increase in sales of the Mega Drive version of the game recently."

Revolutionary Gibbons

Revolution, the team who created *Lure of the Temptress*, have teamed up with comic book artist Dave Gibbons to create *Beneath a Steel Sky*, a cyberpunk-style futuristic adventure. Gibbons' previous credits including the Hugo award for his work on the cult graphic novel *Watchmen*.

Written using a similar engine to *Lure of the Temptress*, the so-called 'Virtual Theatre' system, *Beneath the Steel Sky* tells the story of a man seeking to discover the secrets of a world controlled by computers (it sounds very much like there could be an Arnold Schwarzenegger film tie-in somewhere here).

From what we understand, the game is likely to take advantage of the A1200's 32-bit capabilities, and will be ready for release in the summer through Virgin Games.

STOP PRESS

Also under development from Team 17 is *Alien Breed 2*, and all you lucky A1200 owners out there can rest easy – the A1200 specific version will be released two months before the A500/600 version. This is the kind of trend we think you gamers will have to get used to in the future, as games are more likely to be developed for the A1200 and then ported down to the A600. The future is grand!

Life's a beach
and then you
buy...

Lemmings
The Tribes

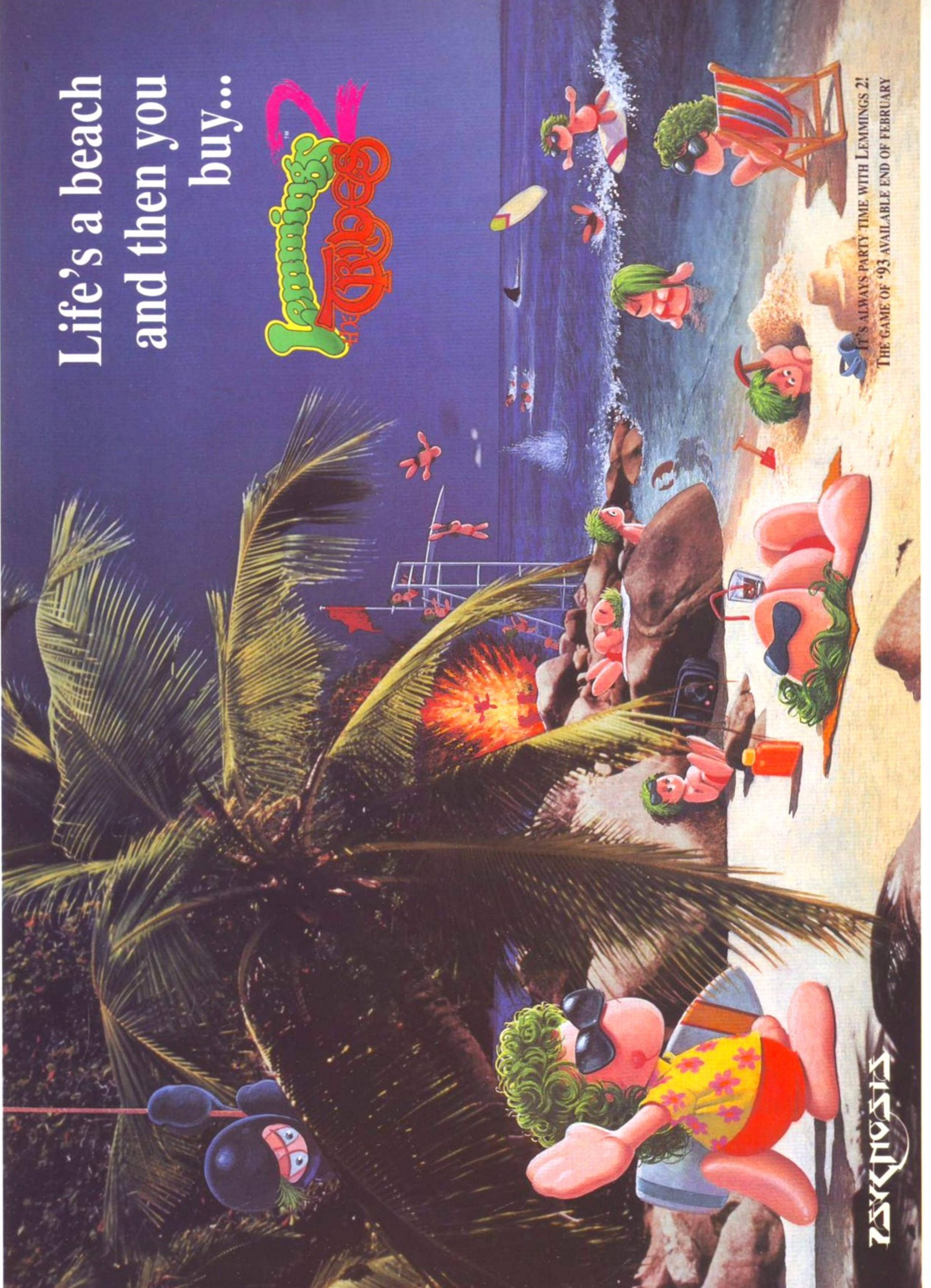

IT'S ALWAYS PARTY TIME WITH LEMMINGS 2!
THE GAME OF '93 AVAILABLE END OF FEBRUARY

THQ



Software Expressions

Introducing some of the best public domain & shareware disks available for the Amiga today. Go on...express yourself!



+ = Plus compatible UTILITIES

- +U001 ...A-Gen (1 meg) Trace your ancestors
- +U006 ...Amigazer For those astrologists
- +U016 ...Biorhythms (1 meg) Chart your feelings
- +U033 ...Education 1 Learn German
- +U035 ...Education 3 Weather
- +U036 ...Education 4 Evolution
- +U052 ...Business Card Maker Simple, but useful
- +U084 ...Wordwright For all you dizlecksicks!
- +U089 ...Journal Very good account-handler
- +U092 ...Cartoon Brushes Lots of famous characters
- +U098 ...Database Master Comprehensive AMOS database
- U104 ...Golf Recorder (1 meg) Excellent disk, with pictures
- +U118 ...Amiga fox D.T.P. Package
- U122 ...Perm Checker Checks pools winnings
- +U123 ...IQ Tester How thick are you?
- +U124 ...Chess Tutor The quest to become a Grand Master
- +U128 ...Viz Clip Art Roger Momy in D Paint
- +U130 ...Label Designer Various label printers
- +U134 ...Ami Cash Best accounts package around
- +U140 ...Amibase Prof Excellent database
- U140 ...Text Engine Excellent word processor
- +U142 ...Super Fonts Lots of Super Fonts
- U144 ...Samples Discs (4 disks) Soundtracker Modules
- U149 ...New Super Killers Updated virus killers
- +U149 ...The Main Event File event editor
- U150 ...Languages Spanish, German, Italian +French dictionary
- +U151 ...Imploder v4.0 File compressor
- +U152 ...PC Task Emulates IBM + PC programs
- +U153 ...File-a-fax As it sounds
- +U154 ...QED Beginners word processor
- +U162 ...The Complete Bible The new testament on disc
- +U164 ...World Databank Creates maps of the world
- +U165 ...A-graph Creates bar graphs
- +U171 ...Understanding Amos Language tutorial
- +U175 ...Text plus VERSION 4 Excellent word processor
- +U178 ... (2 Discs) Analytic ALC (2 Discs) Best spreadsheet available
- +U179 ...Calorie Base Work out your own calorie intake
- +U185 ...Astronomy Calculates positions of planets
- +U187 ...Emulator disc ST - MAC - BBC - MAC File convertor
- +U190 ...Shadow demo maker Create your own demo
- +U194 ...Total concepts Learn about dinosaurs
- +U195 ...Home Manager Create an address book
- +U204 ...Race Rate For horse racing information

DEMOS

- +D015 ...Agatronic Star Wars (1 meg/2 disks) Captivating graphics
- +D016 ...Acid Music Some wicked music & graphics!
- +D058 ...Enterprise leaving dock Famous animation
- +D075 ...Girls of sport Pretty shots of talented girls
- D092 ...Iraq demo (1 meg) Topical cartoon. Bush meets Saddam! Bang!
- +D099 ...Jesus loves Acid Mindblowing music and graphics
- +D114 ...Mike Tyson anim. Well compiled
- +D148 ...The Run (1 meg) T. Richter's car-chase animation. Good
- +D162 ...Stealthy Manoeuvres (1 meg) Excellent demo

- +D166 ...Star Trek Animations Anims. of USS Enterprise
- +D177 ...Star Trek Animations Agatronic no.17 More like above. Good
- +D225 ...Reincarnation of Sgt. Pepper (2 disks, 1 meg) Beatles classic
- D226 ...Virtual World Best demo of year?!
- +D251 ...Debbie Harry (2 disks) Slideshow Blondie
- +D253 ...WWF Wrestlers Hogan & more
- D254 ...Ray of Hope Acidic Demo
- +D278 ...Desert Storm Information on Gulf War

MUSIC

- +M006 ...Batdance remix Really good disk. Catchy stuff
- +M016 ...Depeche Mode 8 Tracks of reasonable quality
- +M032 ...Godbrain loves the world Great acid-house musak
- +M057 ...Powerpack 3 (1 meg) Includes Vanilla Ice track
- +M059 ...Powerpack 5 (1 Mb) 4 classy house tracks
- +M062 ...Random Access Art of Noise and more. Startling acid track
- +M080 ...Pet Shop Boys Manic mix
- +M081 ...Miami Vice Theme music remix
- M084 ...The Wall Pink Floyd classic
- M090 ...Led Zeppelin Stairway to Heaven etc.
- +M093 ...MC Hammer You Can't Touch This
- M094 ...Guns'n'Roses Heavy Metal Freaks
- M101 ...Magic Roundabout As it sounds!

GAMES

- +G001 ...Autobahn 3000 Control ball through tunnel. Hard
- +G003 ...Antep (1 meg) Adventure, also slot cars
- G004 ...Airwar Fighter simulation. Good shareware game
- +G005 ...All New Star Trek (2 drives) USS Enterprise classic. Best one
- +G010 ...Breakout Classic bat & ball game
- +G011 ...Blizzard Horizontal shoot-'em-up. High quality
- G013 ...Bullrun War-game, based on US Civil War. Control army
- +G014 ...Adventure Solutions (2 disks) Loads of hints of commercial games
- +G015 ...Crossfire (1 meg) Excellent game written in AMOS
- +G019 ...Dungeon Delver (2 disks) Difficult adventure quest
- +G021 ...Demolition Mission (1 meg) Similar to Balloonacy, good fun
- +G023 ...Electronic Train Set (1 meg) Construct own train set
- G029 ...Flaschbire Old favourite. Get to alarm clock
- +G031 ...Gravattack Control spaceship, picking up keys
- +G043 ...Learn and Play 1 Good for the kids. Blackboard maths, etc.
- +G044 ...Learn & Play 2 More fun for the kids
- +G053 ...Mayhem Brilliant shoot-'em-up
- G055 ...Mechforce Strategy game
- +G059 ...Nethack (Fish 460) Good adventure game, recently appraised
- G060 ...Pipeline Build an oil pipeline
- +G061 ...Pick up a puzzle (1 meg/2 disks) Fit the pieces. Good for the kids
- G062 ...3D Pool Control cue with mouse, and it's all pot luck!
- G063 ...Pacman The classic game still here
- +G065 ...Pixie Kingdom (2 disks) Tricky adventure game. Good
- +G071 ...Return to Earth (1 meg) Space adventure
- +G072 ...Star Trek : Next Generation Not as good as G005
- +G076 ...Star Fleet Addictive shoot'em up
- G077 ...Seven Tiles Excellent speedball game from Alpha

- +G081 ...Trek Trivia Test your Star Trek knowledge
- +G083 ...Wooden Ball (1 meg) Score three goals to win
- +G084 ...Wet Beaver Tennis Simple, but good fun bat & ball game
- +G086 ...Wraithed One Good general knowledge quiz
- G099 ...Cabaret Asteroids Best version yet. Recommended
- +G102 ...Simulation 1 (1 meg) Recommended. 5 games including Metro
- G104 ...Hints Cheats on commercial games
- G108 ...Llamatron Geoff Minters shoot-'em-up
- +G109 ...Wheel of Fortune TV Quiz, computerized
- +G124 ...Napoleonic Warfare High-quality simulation
- G129 ...Stock Market Speculate at no risk!
- G130 ...Battle Pong Table tennis game-good
- +G143 ...Card Shop Well presented card games
- +G148 ...Galactic Food Fight Blow up those burgers
- +G149 ...Raphaels Revenge Difficult platform adventure
- +G151 ...Hmmm That's not on the Syllabus AMOS adventure
- G152 ...Leaping Larry Jump onto elevators
- +G153 ...Growth Destroy an expanding brain
- G154 ...Jet Man Classic Game
- +G155 ...Mission X Quality shoot-'em-up
- +G157 ...Quadrix Difficult puzzle game
- +G165 ...Super Skoda Challenge Car racing game
- +G170 ...Amos Cricket 'Owzat!
- +G171 ...Top Secret Quality platform game
- +G175 ...Whizz Wall NEW Wizard shooting game
- +G176 ...White Knight NEW Excellent shoot'em up game
- +G180 ...Tank Attack World War 2 Simulation+
- G181 ...Quick 'n' Silver Great platform game
- G187 ...Assassins 11 Five games
- G188 ...Assassins 12 3 more games including power pong
- G189 ...Assassins 13 6 games including twintris
- G191 ...Assassins 15 Battlecars and litrix
- G192 ...Assassins 16 Wastelands, Mission X + Dilema
- G196 ...Assassins 20 5 games including Coin Drop
- +G197 ...All rounder Cricket game
- G198 ...Snakes & Ladders Addictive classic
- +G204 ...Super League Manager Manage your own Soccer team+
- +G208 ...Grand Prix Simulator Excellent
- +G209 ...Games Galore Ten 14 excellent games
- G211 ...Croak Frogger clone
- +G214 ...Parachute Joust Try & catch a parachute
- +G215 ...Battlements Hunchback game
- +G217 ...Act of War Excellent strategy game
- +G218 ...Roulette Casino Classic
- +G219 ...Space Rescue Guide Spaceship through Terrain
- +G220 ...Sub Attack Also landmine + bomber
- +G221 ...Revenge of the mutant camel Shooting game
- +G222 ...Neighbours adventure (2 discs) Bring Paul Robinson to court
- +G223 ...Wizard Wars Graphics Adventure

+ Indicates + Compatibility — or a 600 Compatibility

Blank disks

10 for £4.99
or 53p each

CATALOGUE DISKS

75p each

POSTAGE

UK orders : 70p
Europe : £1.25
World : £2.50

PRICES

PD....£1.25 per disk
or
£1.00 each for 15 or more.

Send cheque/postal order made payable to :

SOFTWARE EXPRESSIONS,
44 Beaulieu Road, Southville,
Bristol BS3 1PY
9am-5pm Mon to Fri

0272 639593

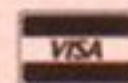

PACKS

ASSASSINS GAMES

1 - 24

£20

GAMES GALORE

1 - 9

£8.50

BUSINESS PACK

(6 DISKS)

+ COMPAT

£5.50

AMMIGA FORMAT

Live, 93

WEMBLEY EXHIBITION CENTRE
7 - 9 MAY 1993

**The best Amiga
magazine in
the world...
...goes Live!**



What do we mean, Amiga Format is going live? That the world's best-selling Amiga magazine is turning into some kind of Frankenstein's monster?
Well, no. What we mean is that we've arranged a very special event this Spring for all Amiga owners. It's going to be a computer show like no other, arranged exclusively for Amiga owners and inspired by the people who run Britain's favourite computer magazine.
What will be happening there? Well, first and foremost there will be stall after stall overflowing with great Amiga bargains - games, hardware, serious software, the lot. Just like in Amiga Format.
Naturally, because it's a live event that also means you can get advice and see products demonstrated by the people who make and sell them. Which makes life an awful lot easier.
And that's as well as taking advantage of some very special prices.
So it's a great place to go shopping, but there's a lot more besides.
Commodore, the makers of the Amiga, are giving their full backing to the event and will be there in style.

What happens when the world's top magazine goes



3D
260
100% 75% 50% 25%
AMOS 3D
AMOS 3D
AMOS 3D
AMOS 3D

The Amiga Format team will be there along with a host of other Amiga experts, to have a chat, answer your questions and help you out with any specific Amiga problems.

A special Sound and Vision area will concentrate on Amiga graphics and music, and how they can be used in making your own videos.

For gamers, there's the Amiga Power arcade where you can see - as well as play - all the latest top game releases. And you can experience virtual reality for yourself, too.

The venue has yet to be confirmed, though it's a prestige central London site, and much more has yet to be revealed about what new products will be launched at the show, and other special events, so keep an eye on the news pages of your favourite Amiga magazine.

But what's certain is that it's going to be quite an event. If you've got an Amiga, you really ought to be there. So make sure to get it arranged right now, and we'll see you there!

When Amiga goes live?

AMIGA FORMAT

Live '93

**WEMBLEY EXHIBITION CENTRE
7TH - 9TH MAY 1993**

Tickets can be booked in advance with our credit-card hotline 051-356 5085 which means you get in for a bargain £5.95 and you don't have to queue to get a ticket. Entrance on the day costs £7. Opening hours are Friday 7 May and Saturday 8 May 9.30am to 5pm, Sunday 9 May 9.30am to 4.30pm. See you there!

Booking form

Yes please! I'd like tickets!
Number of tickets (at £5.95 each) _____
Total payment £ _____

Name _____

Address _____

Method of payment (please tick)
Credit card number _____
Expiry date _____

Access
Visa
Cheque PO

Postcode _____
Please make all cheques payable to Future Events
Send this coupon to AMIGA FORMAT LIVE '93,
PO Box 2, Ellesmere Port,
South Wirral
L65 3EA.

The best a word processor can be...

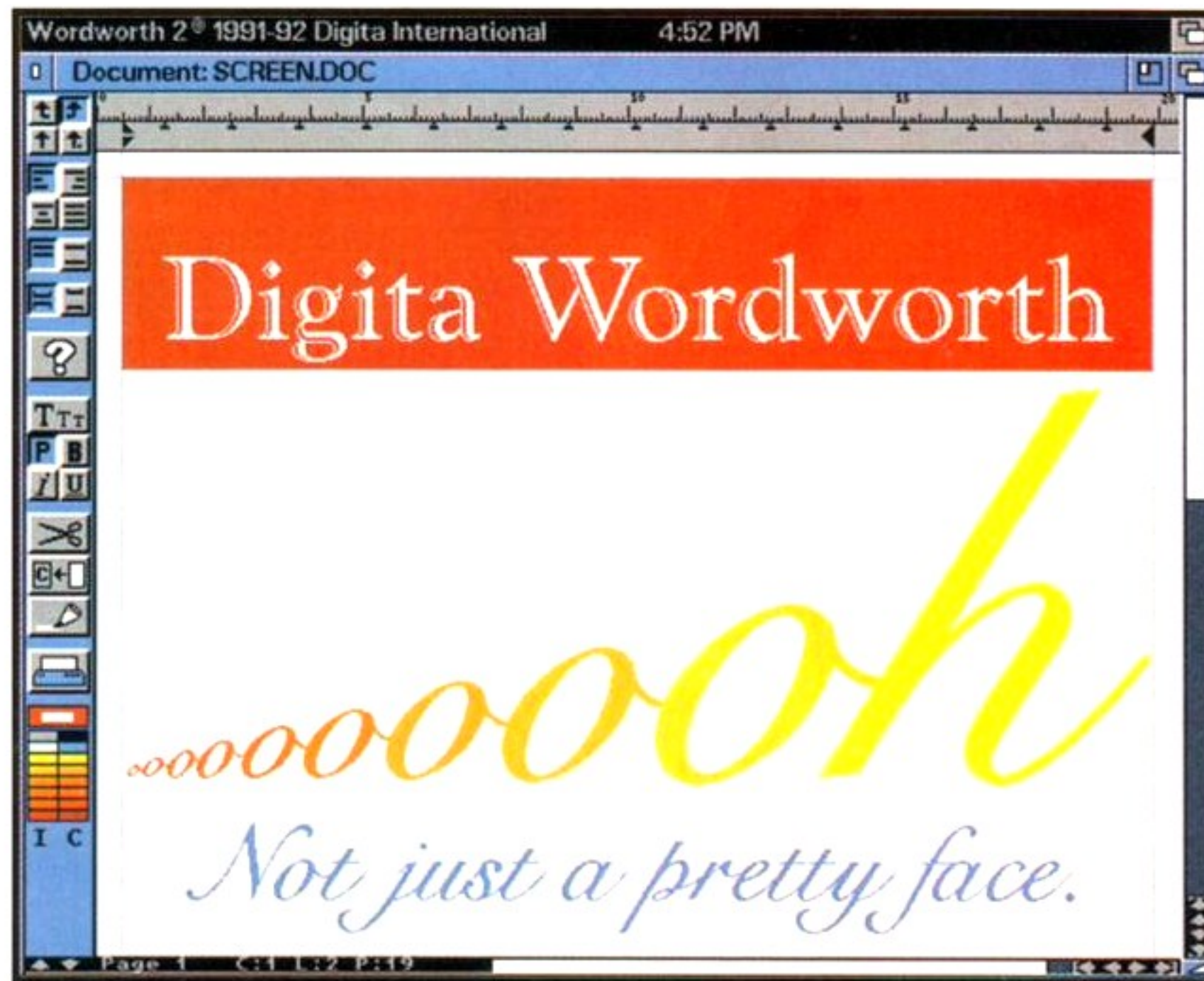

If you want to take a closer look at the new Wordworth call 0395 270273,
or write to Digita, FREEPOST, Exmouth EX8 2YZ ENGLAND



"The ultimate in word processing power"



Voted Best Word Processor
"Inspirational, that's the word"



Voted Best Word Processor
"A good length clear of the field"



Best printer support



Best silky-smooth printing



Best Compugraphic fonts



Best research and testing



Best interface design



Best technical support

Wordworth, simply the best.



Digita International Limited Black Horse House Exmouth EX8 1JL England Telephone 0395 270273 Facsimile 0395 268893

- A member of the Digita group -
Digita, the Digita logo, and Wordworth are registered trademarks of Digita Holdings Ltd. Scalable type outlines are licensed from Agfa Division of Miles Inc. Agfa is a registered trademark of Agfa-Gevoert, AG. Intellifont is a registered trademark of Miles Inc. Digita Holdings Ltd acknowledges that all registered and other trademarks used in the text of this advert are the properties of their respective companies. Whilst every care has been taken to ensure that the information provided in this advert is accurate, Digita Holdings Ltd cannot be held liable for any errors or omissions that may have occurred. Sold subject to standard conditions of sale. E and OE.

Unlock the power of your Amiga

with the Amiga Format Instant Software Library

Having a super-duper expanded Amiga, with 8Mb of RAM, an accelerator and a 24-bit card is all very nice, but until you get some decent software to run on it, it's completely useless. Choosing the correct software for the job can be a difficult task, so on the next seven information-packed pages, we take a look at the main areas of Amiga usage and tell you what software rules the roost in each discipline.

You have an Amiga, or you're thinking of getting one. Either that or you're stood in Smiths waiting for your girlfriend and this looked like as good a magazine as any to have a browse through. But for simplicity's sake we'll assume you have an Amiga. You may have bought it to play games on, or you may have bought it for some other, more serious, purpose. But whatever reason you got it for, you need software to get anything useful out of it at all. Whether that software be *Streetfighter 2* or *Professional Calc*.

The Amiga is so good at so many things though, that to just use it for one or two tasks is a bit of a waste, no matter how well it handles those tasks. Many of us know that our machines are capable of far greater things, but we're not quite sure about how to go about doing those things. Well it all begins with software. For a home computer, the Amiga has a dazzling array of software packages to do all sorts of things, from predicting the form of race-horses to creating professional-quality DTP documents, and everything and anything in-between.

But if you decide you want to go at word processing how do you decide which bit of software to use? You could go down to your local Dixons, but the staff there have been known to think RAM stands for Robot Astounding Memory. You could try your local specialist computer shop, and this is quite a good idea, but some shops will try and sell you what they have, rather than what you need. So it's a good starting point to go into the shop with some idea of what you're after. Enter *Amiga Format*, every month we review and rate all the latest software, and we frequently produce round-ups of software and hardware in order to help you make your buying decision.

In the next few pages, we're going to take a look at some of the most popular areas of Amiga usage, and tell you what we've found to be the absolute best in software. And because the best sometimes costs the most, we'll be looking at three price points: the expensive, cost is no problem, a more sensibly priced piece of software and the absolute bargain software that you can pick up in the Public Domain or on a Coverdisk on a back issue of this very magazine.

This guide is intended for someone wanting to try out something new on their Amiga. While the programs in the following pages are by common consensus the best of the best; if you have very special or precise requirements of a piece of software, try before you buy. Or better still refer to the original full reviews in *Amiga Format*.





UNLOCK THE POWER Music

AMIGA FORMAT

THE ATARI ST has always been the most popular music computer, due to its built-in MIDI facility. The Amiga, though, has made big gains and there's now a good selection of Amiga packages for all levels of virtuosity, from the novice to the professional.

DR T'S KCS 3.5 LEVEL II £279
ZONE ■ 071-738 5444

KCS was one of the Amiga's first MIDI packages, but it wasn't very accessible. So Dr T's sharpened it up



Dr. T's KCS, the most powerful keyboard sequencer for the Amiga, comes with a whole suite of programs.

and re-released it with an extensive suite of ancillary programs. The package features the *KCS* sequencer; *Tiger*: a graphical sequence editor, that lets you set up a note sequence; *Automix*: a computer based mixing desk which allows you to control the stereo panning and volume of tracks during mixdown; *Quickscore*: allows you to get hard copy of your track from a printer; and *Phantom*: allows you to sync the sequencer to several popular multitrack tape recorders. Flexible, powerful and reasonably priced.

STEREO MASTER £39.95
MICRODEAL ■ 0726 68020

As with any sampler, *Stereo Master* requires some hardware. Basically just a sampler, it has a simple sequencer feature, but this function is limited. The program has reasonably good sample-editing features and some useful effects that can be applied to sampled sounds. It can be bought from our mail order pages



If you want to make a bargain start in the world of sampling, Microdeal's *Stereo Master* is for you.

(172-174) and is bundled with Quartet. This helps make up for the poor sequencing features by offering a free, fullfeatured MIDI sampler.

MED
AMIGANUTS LTD

There is no shortage of good PD and shareware. If you are looking for an Amiga sequencer, take a look at *MED* from Amiganuts Ltd, this shareware program features MIDI compatibility, inbuilt sampling and sound synthesis facilities, all for a mere £10. Now on version 4, and constantly being updated, *MED* gives full-price programs a run for their money. This package is the choice of many serious tunesmiths and it has the added advantage that *AMOS Professional* can play *MED* tunes, so they can be easily assimilated into games and have other programs written in it.

MARCH 1993

Desktop publishing

THE AMIGA HAS a long DTP history, and at one time there was a Canadian magazine that was designed and laid out totally on an Amiga. There is no shortage of DTP software for the Amiga. But DTP programs are very complex and take a lot of machine power and memory, so be sure and check that your machine meets the program's specification before buying. And remember a DTP package is no good without a printer.

PAGESTREAM 2.2
£199.95 ■ SILICA ■ 081-309 1111

The most professional DTP program the Amiga can boast, *PageStream* is an immensely powerful tool, yet it can be run on a relatively modest Amiga setup. Just 1 meg and 2 floppy drives are all it takes to start



Professional DTP on the Amiga reached new heights with the release of *PageStream 2.2*.

producing excellent looking lay-outs in *PageStream*. If you have a more powerful system, *PageStream* will exploit it to the full. Although it is very simple to use the program boasts some very interesting features.

Structured graphics can be edited on the page, and text can be skewed, perspectivised and rotated. It offers full-colour PostScript support, which means it can output printer's film from a very high resolution printer called an imagesetter. Agfa Compugraphic, Soft Logik and Adobe Type 1 fonts are all useable by this incredibly powerful program. The choice of Professionals.

PAGESETTER3
£49.95 ■ SILICA ■ 081-309 1111

At an unbelievably cheap price, Gold Disk's new version of *PageSetter* offers a more complete package than any other DTP program. Not only do you get a capable layout program, but a paint program and word processor as well.

Full AGA support means that on the new A1200/4000s the screen displays in 256 colours, giving this package the honour of being the first Amiga DTP program to be able to display graphics in colour. This is by far the cheapest Amiga DTP program ever to offer colour support, but sadly the PostScript printer support doesn't give colour separations. Despite one or two minor niggles, this program represents an incredible bargain at the price. See the full review on Page 146 of this issue.



A full-colour DTP package for under £50, you cannot be serious! We are and it's called *PageSetter 3*.

AMIGA FOX
PUBLIC DOMAIN

It wouldn't really be very fair to expect too much of a PD DTP program, especially one which only occupies a mere 42K of RAM. But the thing is *Amiga FOX* is surprisingly good.

Sadly offers no colour support, but what do you expect at the price. The features are about equal to the original *PageSetter* (given away on the AF34 Coverdisk, but now sold out). If you think you want to try DTP, but aren't sure, give this a go.

THE BEAUTY OF computer painting is that you can change your image as many times as you wish. Not to mention all the excellent tools that computer art packages have, which enable you to draw perfect squares and circles and let you do lots of other things.

You never have to wash out your paint brushes, and there's no chance of ruining your favourite clothes, or worse still the lounge carpet by getting paint all over them. All this is before we even mention animation. Most computer art packages are capable of animating your creations in one way or another.

Paint packages for the Amiga are common, after all the machine is renown for its graphical capabilities but the best are...

DELUXE PAINT IV

£89.95 ■

ELECTRONIC ARTS ■ 0753 549442

The long-time champion of the Amiga paint program battle - *DPaint*, as it is often known - has been around for almost as long as the Amiga itself. Its basic layout and tools have been imitated by hundreds of pretenders, yet none have managed to combine *DPaint*'s power and ease of use.

Electronic Arts, the producers of *DPaint*, co-operated with Commodore on the creation of the IFF (or Interchange File Format), which has become the Amiga's standard file format, particularly for pictures. Now in its fourth incarnation, *DPaint* will be very familiar to many Amiga users, since earlier versions of the program have been given away in various Amiga bundles.

But version 4 really is that bit special, it was the first Amiga paint package to enable users to use both

Paint packages

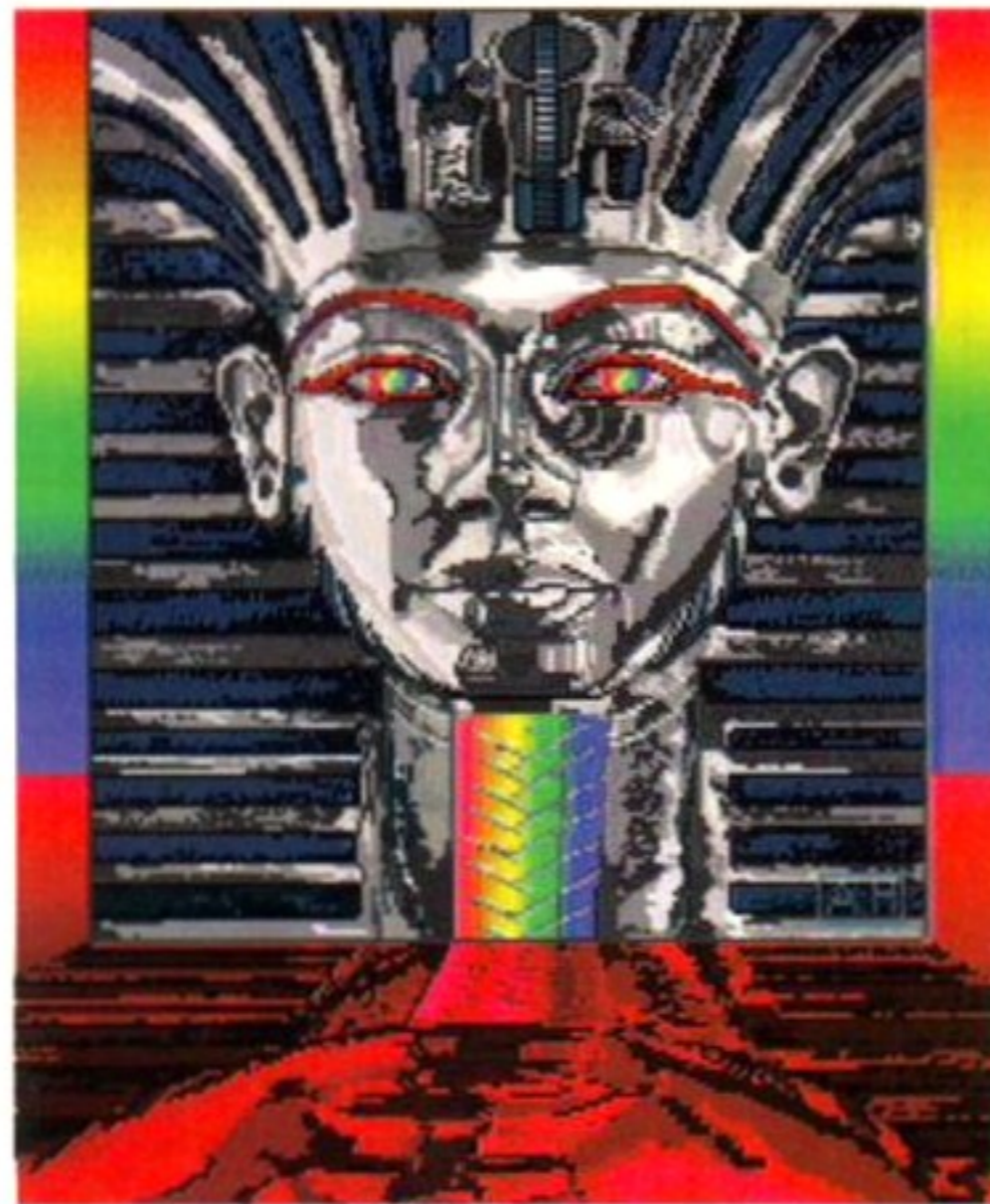

King Tut's head has become a symbol for quality paint packages since being adopted by EA for their *DPaint* series.

HAM and normal screen modes. The same tools as always are there, but the addition of 4,096 colours and an ingenious mixing palette to help you get the most from them, elevate *DPaint* above the competition. A range of image-processing effects also add to the power of *DPaint IV*. Although it can be slow in HAM mode, this is still the paint program to have. A1200 users should check out the AGA version of this program, reviewed on Page 132.

SPECTRACOLOR JR

AMIGA FORMAT 35

If you want a paint program on the cheap, *Spectracolor Jr*, on Amiga Format 35 Coverdisk is difficult to beat. This HAM-only paint package has all the usual tools you would expect, but on top it has a nifty feature that allows you to wrap a brush onto a geometric shape. If you can cast your mind back to Amiga Format 30 (if not check out the back issues on Page 168 of this issue), this is the program that we used to make the Christmas baubles on the cover of that issue.

THE USEFULNESS OF a good database cannot be overestimated. Here in the Amiga Format offices we are just compiling a database of everything we have ever reviewed, complete with which issue we reviewed it in, on what page and what score it got. Imagine how useful that will be. But there are many other uses for a database, what is your address book if not just a database of the people you know and what their address and phone number is. Imagine having all that data to hand instantly, sorted as you need it. That's what a database is for.

SUPERBASE PROFESSIONAL 4

£411.19 ■ OXXI AEGIS

0101 310 427 1277

The mother and father of all things databasal, *Superbase Pro 4* has more features than anyone could ever possibly use, but if you do need a particular feature you can bet it's in there. Apart from the usual stuff like user-definable records and multiple sort fields,

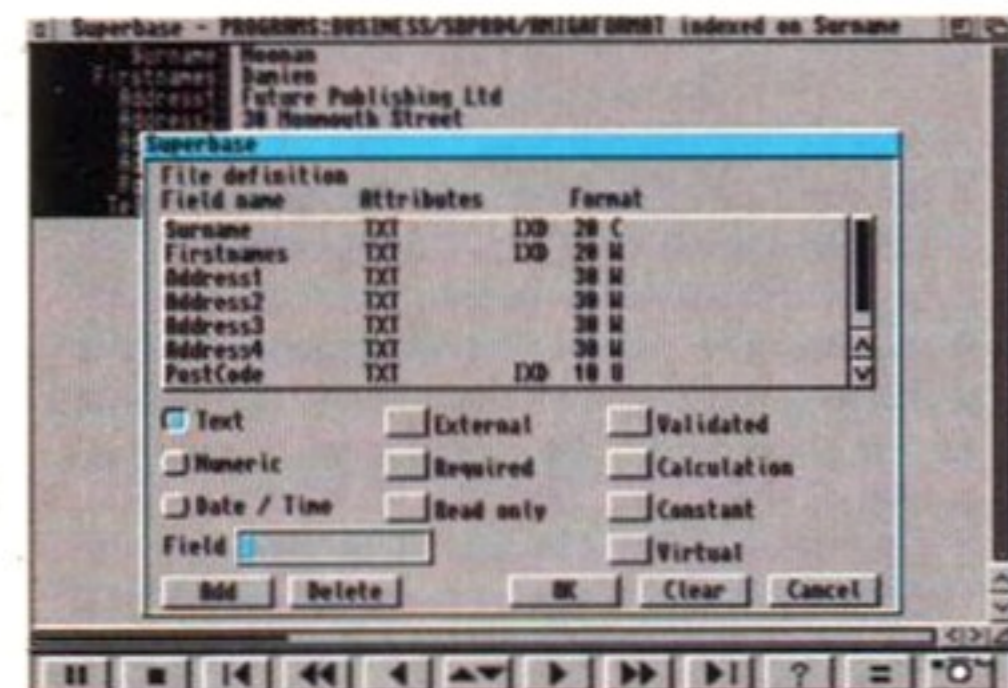

Hey, it's a database, what do you expect. It may look boring, but Superbase Professional 4 is superb.

Databases

Superbase Professional has an object-orientated forms designer. This feature lets you design screen versions of forms, so that the person entering the data doesn't have to deal with the database program beneath.

One truly amazing feature is sound and picture file support, so part of your record can be an actual IFF picture or sound sample, meaning you can create a multimedia database. The only problem with *Superbase Professional* is the price, it comes in at over £400, although the price is expected to fall drastically in the near future.

SUPERBASE PERSONAL 2

£99.95

OXXI AEGIS ■ 0101 310 427 1277

For a more reasonable price, it is possible to pick up *Superbase Professional*'s little brother. And though the price is a lot lower, the specification isn't. This is still a well-featured database. Like its big brother, sound and picture files can be played or displayed as part of a record. You can sort data via 999 separate indexes, have up to 16 million records in any database and an unlimited number of fields per record.

The maximum file size it can handle is 17 gigabytes, which is large enough for all but the tax departments of medium-sized countries. Databases are sortable on any field and all these records are accessible through an easy-to-use, VCR-style control panel. Until *Superbase Pro* is available for under £200 this is the best value database on the Amiga.



Superbase Personal, like the *Professional* version can display picture files as part of a record.

AMOS DATABASE

DEJA VU ■ 0942 495261

Without a shadow of a doubt the best database on the PD circuit has to be the *AMOS database*. As the name suggests, it is written in AMOS. Its very impressive frontend allows access to a powerful database with masses of text and picture manipulation facilities.

Pop-up menus for virtually everything make file access a simple matter. If you want a database for next to nothing, then you need look no further than this excellent piece of software, and it'll cost you virtually nowt.

UNLOCK THE POWER

DRAWING PROGRAMS CREATE a picture by defining a series of points, and the lines that connect these points. The resulting drawings can be rescaled to any size without becoming jaggie, or bitmapped. Drawing programs are useful when used with DTP programs, for the creation of diagrams and logos.

PROFESSIONAL DRAW 3 £99.95

SILICA SYSTEMS ■ 081-309 1111

Originally created as a partner for the *ProPage* DTP software, *ProDraw* was for a long time the only structured-drawing package for the Amiga. In fact the file format used by *ProDraw* has become the standard for Amiga drawing packages. *ProDraw* has all the features you could want from a drawing package, like geometric, freehand and bezier drawing tools and more. One useful feature is the autotrace facility, this allows you

Drawing packages

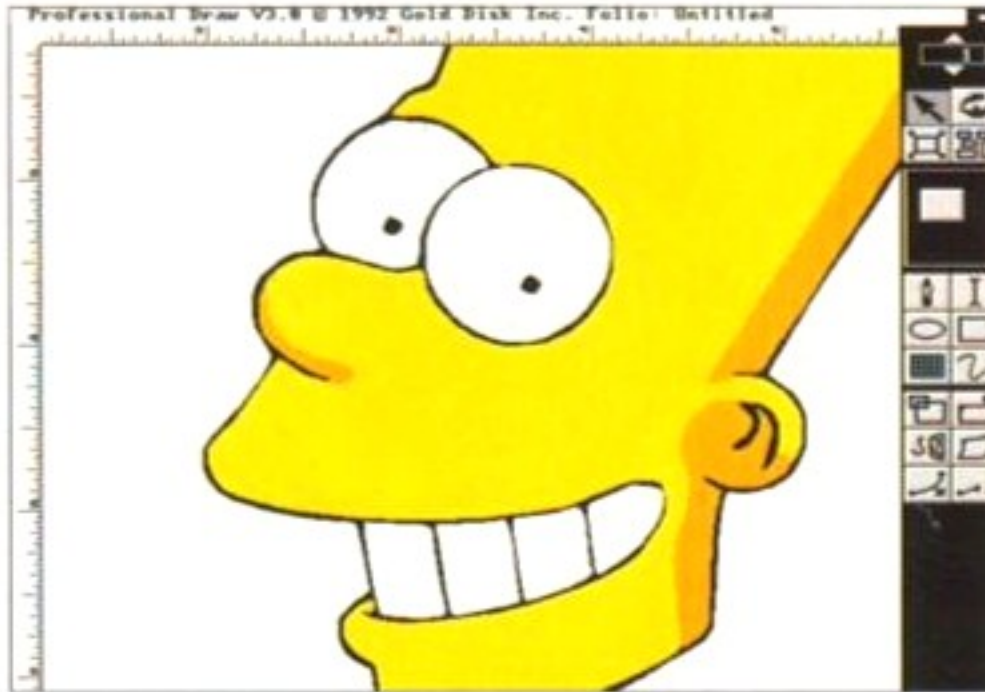

As long as you've got a hard drive, *Professional Draw 3* is the answer to all your structured drawing worries.

to take an IFF image created in a bitmap drawing package and convert it into a structured drawing, which can then be edited in *ProDraw*. It supports full colour and even offers graduated fills. One feature to *ProDraw* is the support of ARexx by means of macros called Genies. These enable you to group a complex series of operations under one name, and access them via the Genie button. This can make certain repetitive tasks a lot easier and less boring to perform. The downside to *ProDraw* is that it is only useable by hard drive owners.

EXPERT DRAW £79.95 HB MARKETING ■ 0753 686000

Has many of the features of *Professional Draw*, but at a lower price. The only sensible option for Amiga owners without a hard drive. It handles *Pro Draw* clip format drawings, and can use Agfa Compugraphic outline fonts with the optional converter program. Aside from the usual drawing features, it has a neat morph-style utility. This allows you to select two objects and create a number of in-between objects that slowly change in shape and colour from one to the other.



For non hard-driving Amiga owners, *Expert Draw* offers most power for least money in the drawing stakes.

Word processing

WORDWORTH2 £129.99 DIGITA ■ 0395 270273

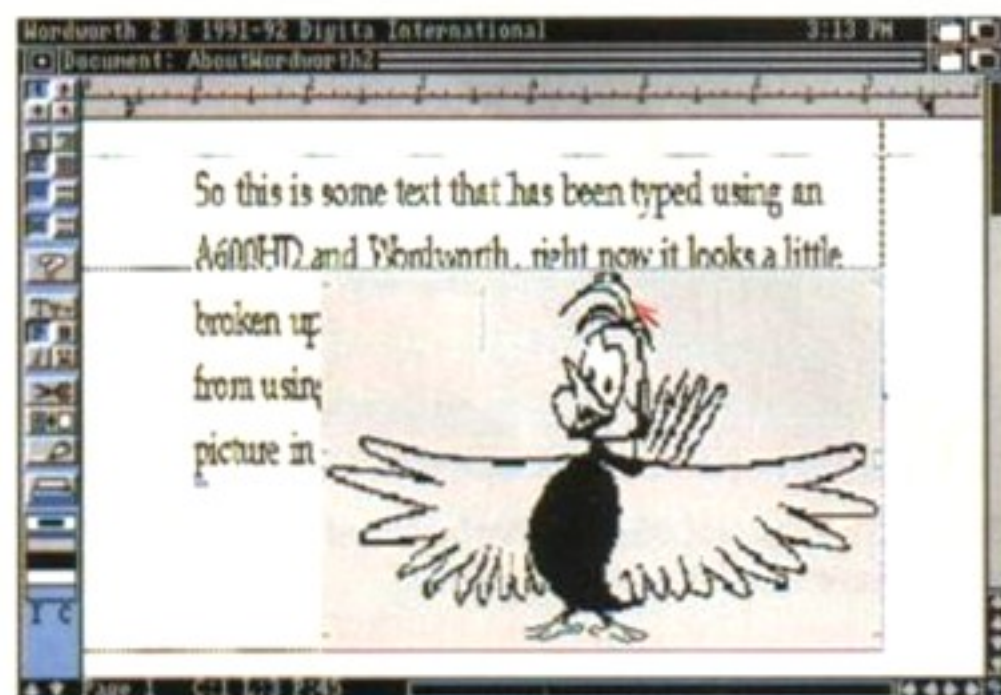

If a picture said a thousand words, then you wouldn't need *Wordworth 2*, but they don't so you might.

A document processor rather than a word processor, *Wordworth* has the added advantage of being able to include IFF pictures in its page. Of course if all you desire is a tool to bash out as many words in as short a time as possible, such frippery may not be for you. But if, like many people, you are trying to produce good-looking documents with a variety of fonts, formatted into more than simple paragraphs and chapters, *Wordworth* hits the spot like a laser-guided missile.

Digitas Human Interface Protocol (HIP) gives *Wordworth* a very useable frontend. Many features that

are usually menu driven are available at the press of a button in *Wordworth 2*. An indexing facility makes creating tables of contents easy, and opens up the world of reference-work writing to *Wordworth* users.

You need a 1.5Mb machine to get the best from it, and a hard drive would be a big advantage too, but when you get the best from *Wordworth*, you really are getting the best.

PEN PAL £79.95 SOFTWOOD ■ 0773 836781

As document processors go, it may not win any prizes, but on price alone it's a hard act to beat. Its only serious downfall is failure to support outline fonts, which

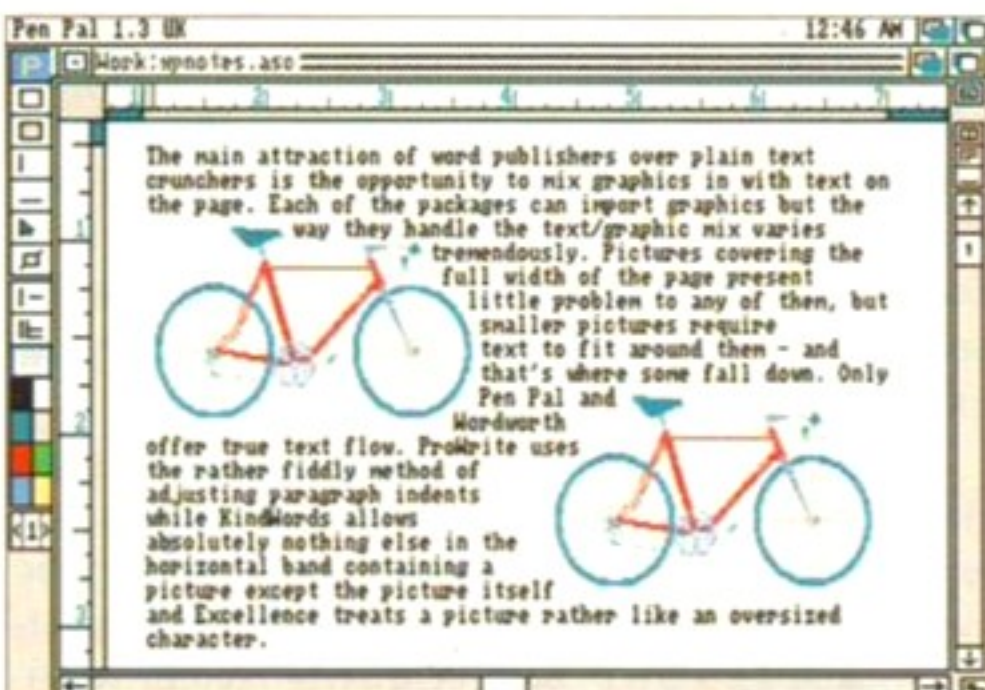

Much more than half the features of a top quality document processor, for about half the cost. Can't be bad.

means that output quality is not as good as some. But aside from this, it has all the features you're likely to want from a word publisher. If a word processing package could ever be fun to use, this is the one, and it scores heavily on accessibility and ease of use.

But *Pen Pal* is not without a trick or two, it's the only word publisher that allows you to import, display and print a HAM picture. It has an in-built flat file database, making it great for mailing lists. All in all it's a popular package, in fact most of this feature was written using it. Expect to see it come down in price, since publishers Softwood have recently released *Final Copy 2* and will be wanting to keep the products out of one another's territory.

SCRIBBLE! AMIGA FORMAT 41

A full word processor for only five pounds, with a complete issue of *Amiga Format* stuck on the back for free. What a bargain. And the manual, thesaurus and spelling checker are available from HB Marketing for a mere £9.95. *Scribble!* is no PD effort either, it's a respected commercial package, which was available for a long time as a full-price product. In fact it is probably the most famous Amiga word processor ever. If you need a no frills text engine for banging out your reports, theses, essays, or even your autobiography, *Scribble!* is hard to beat.



X-BACKUP PROFESSIONAL

A1200 HARD DISKS
AND MEMORY
UPGRADES NOW
AVAILABLE.
PHONE: 061
724 7572
NOW

Existing owners, please phone for upgrade details.

X-BACKUP PRO

NEW VERSION

£39.99

PLUS £1.00
POSTAGE

X-BACKUP PRO

THE BEST
AMIGA DISK
COPIER.
GUARANTEED

For Amiga A500, A500+, A600, A1200,
A1500, A2000, A3000 & A4000

INCLUDES NEW
MULTIFUNCTION
'CYCLONE'
CARTRIDGE
FOR INCREASED
COPYING POWER

X-BACKUP PRO is the most powerful disk duplicator/utility package ever designed for the Amiga. For duplicating your original software, X-BACKUP PRO is a must, however it offers so much more.

Unlike other copiers, X-Backup is fully automatic and **NO** technical knowledge is needed. Even a beginner can use X-Backup!

HOW TO ORDER X-BACKUP PRO:-



Telephone our sales hotline with your credit card details for immediate despatch.

061 724 7572



Send a cheque or postal order for £40.99 made payable to SIREN SOFTWARE to Siren Software, Wilton House, Bury Road, Radcliffe, Manchester M26 9UR.

- ✓ Copies virtually all known disks, far more than any other copier available.
- ✓ Also backs up hard disks. Ideal for A600HD owners.
- ✓ Full file management/copying utility.
- ✓ Optimises data for faster loading.
- ✓ Formats, repairs, verifies. More than just a copier!
- ✓ Includes the new CYCLONE cartridge.
- ✓ Official U.K. version. Includes 8 page manual.

GUARANTEE:- X-BACKUP PRO is the most powerful disk copier available for the Amiga. If at the time of purchase, you can find a superior copier, we will REFUND YOUR MONEY.

Can any other copier offer you that?



PHOENIX

FREE! FAST! UK DELIVERY

SAME-DAY DESPATCH! * NEXT-DAY COURIER ONLY £4.50

ALL PRICES INCLUDE VAT!

Tel: 0532 311932



PHOENIX, UNIT 19, ARMLEY PARK COURT, STANNINGLEY ROAD, LEEDS LS12 2AE. Please make cheques payable to PHOENIX. Allow 5 working days for cheque clearance. BFPO welcome. NORMAL OPENING TIMES: Mon-Sat 9.00am-6.00pm FAX: 0532 319061 E&O.E. * On Credit card orders/bankers draft/building society cheque/Postal orders.

NEW AMIGA 1200

Probably the home computer of the decade, the A1200 is the latest addition to the Amiga family. Incorporating a new internal engine and many more exciting and powerful features, this machine truly takes the Amiga family into the next generation!!!!!!

FEATURES INCLUDE: 68020 Processor Running at 14 Mhz • 2Mb Chip RAM (expandable) 256 colours on screen from a 16.8 million colour palette • Full Amiga Key board (with Alpha numeric key pad).

Phoenix Price Only £379.99

GVP/1200-Hard drive Upgrade 85 Mb ultra fast Maxtor 2.5" drive • GVP Formatting software • installation manual • All necessary screws and cables

Phoenix Price £284.99

PHOENIX A1200 HARD DRIVE UPGRADES - Now Available!

Lightning fast access times • Highgrade 2.5" Connor hard drives • Fully fitted and tested by Phoenix technicians • 1yr. warranty on all models 20 Mb - 40 Mb - 60 Mb - 80 Mb - 120 Mb - 200 Mb

Call for the lowest prices in the U.K.

A1200-PCMCIA Fast RAM Expansion Credit card memory now available 2Mb £129.99 4Mb £199.99

A1200 32-Bit Trapdoor RAM Expansion includes 16 Mhz 68881 co-processor!! Microbotics MBX 4 Mb £299.99 Microbotics MBX 8 Mb £424.99

A 1200 ACCESSORIES

Control Centre (inc. FREE cables) £36.99 Dust Covers £5.99 Multi-Sync Monitor adaptor cable £9.99

AMIGA'S

'CARTOON CLASSICS PACK' It's Back and it's bad - the pack they tried to kill returns for its final mission - don't miss this golden opportunity to acquire one of the best ever home computers, features include: 1 Mb of RAM Workbench 2.04 • TV modulator • Lemmings • Captain Planet • The Simpsons • Deluxe Paint III Phoenix Price £249.99!

'THE WILD, THE WEIRD & THE WICKED' 1 Mb A 600 as standard and includes the excellent value Software titles: Deluxe Paint III • Formula One Grand Prix • Putty • Pushover Phoenix Price £319.99! A 600 2Mb (incl. above software) £359.99

'EPIC•LANGUAGE PACK' 1 Mb A 600 as standard and includes 20MB HARD DRIVE the excellent value Software titles: Deluxe Paint III • Trivial Pursuit • Epic • Myth • Rome Phoenix Price £399.99! A 600 2Mb+20 Mb Hard Drive £439.99 (both include the above detailed software)

A 600-The stand-alone A 600 is compact, semi portable, fully featured and can be purchased in the following configurations: A 600 £279.99 A 600 2Mb £314.99

AMIGA 1500 2.04 Workbench Includes: Deluxe Paint 3, Platinum Works, Home Accounts, Toki, Puzznic, x Elf, Amiga Format Book and Joystick AMIGA 1500... NOW ONLY £479.99 AMIGA 1500 + 52 Mb hard drive... £689.99

ACCELERATORS

500/500+/1500/2000 32-Bit technology at a price you can afford. Ray tracing an image that takes 24-hrs on a standard Amiga takes just 1 hr. 36 mins. with an A5000!! FREE maths co-pro included with both A/B5000 accelerator cards.

Table listing accelerator cards: A5000 + 1MB 16.67 Mhz £159.99, A5000 + 2MB 16.67 Mhz £198.99, A5000 + 3MB 16.67 Mhz £234.99, A5000 + 4MB 16.67 Mhz £269.99, B5000 + 1MB 25.00 Mhz £282.99, B5000 + 2MB 25.00 Mhz £329.99, B5000 + 4MB 25.00 Mhz £424.99, B5000 + 8MB 25.00 Mhz £604.99

HARD DRIVES

GVP IMPACT SERIES II Hard Drives, the fastest Hard Drive/Controller for the Amiga. Features Game Switch, external SCSI port, FAAASTROM SCSI Driver, GVP's custom VLSI chip and internal RAM expansion up to 8 meg! Units use high specification fast-access QUANTUM Hard Drives coming with 2 yr. guarantee.

Table listing hard drives: 500/500+ A500-HD8+ 42 Mb £329.99, A500-HD8+ 80 Mb £389.99, A500-HD8+ 120 Mb £499.99, A500-HD8+ 213 Mb £662.99, A500-HD8 controller only £179.99

Table listing hard drives: 1500/2000 Series II Hard Disk Controller/RAM card £122.99, Series II 42 Mb Hard Disk and RAM card £309.99, Series II 80 Mb Hard Disk and RAM card £379.99, Series II 120 Mb Hard Disk and RAM card £454.99, Series II 213 Mb Hard Disk and RAM card £614.99

ACCELERATOR-HARD DRIVES

500/500+ GVP COMBINATION ACCELERATORS & HARD DRIVES-The ultimate expansion product for the Amiga 500!

Table listing accelerator-hard drives: A530 Combi 40MHz + 42Mb Hard Drive £709.99, A530 Combi 40MHz + 80Mb Hard Drive £804.99, A530 Combi 40MHz + 120Mb Hard Drive £879.99, A530 Combi 40MHz + 213Mb Hard Drive £1039.99, A530 68882 Co-Processor £219.99

Table listing hard drives: 1500/2000 GVP G-Force 030-25MHz + 1Mb £474.99, GVP G-Force 030-40MHz + 4Mb £757.99, GVP G-Force 030-50MHz + 4Mb £1136.99, GVP G-Force 040-33MHz + 4Mb £1419.99

GVP Accelerator RAM 1Mb Simm-32 Bit 60 Nanoseconds £65.99 4Mb Simm-32 Bit 60 Nanoseconds £182.99

EMULATORS

Table listing emulators: GVP PC-286 16MHz £239.99, KCS Powerboard A600 £165.99, KCS Powerboard A500/500+ £146.99, KCS adaptor for 1500/2000 £57.99, Vortex A Tonce Plus 286 (16MHz) £214.99, D.O.S 4/5 £POA, Vortex 'GOLDEN GATE' £419.99

MONITORS

All monitors are supplied with a FREE cable for connection to your Amiga.

PHILIPS 8833Mk II... ONLY £224.99 Colour Stereo Monitor now including 'Lotus Turbo Challenge', and 1 years on-site warranty.

COMMODORE 1084 STI... NEW! £199.99 Brand new high quality Monitor with built in Tilt 'n' Swivel monitor stand

Table listing monitor accessories: 14" Dust covers £4.99, 14" Tilt & Swivel stand £13.99, Anti-Glare filter screen £19.99, A4 Copy Holder £12.99

MEMORY EXPANSION

500/500+ SUPRA 500RX the ultimate in Fast Ram expansion units. (*Uses 256x4 Zips)

Table listing memory expansion: 8 Mb pop to 1 Mb* £99.99, 8 Mb pop to 2 Mb* £124.99, 8 Mb pop to 2 Mb £149.99, 8 Mb pop to 4 Mb £209.99, 8 Mb pop to 8 Mb £309.99

A 500+ A PHOENIX RAM module can expand your chip RAM up to 2 Mb by using the trapdoor expansion port. Extra RAM is necessary to unleash the incredible graphics capabilities of your Amiga. All our boards carry a full 2 year no quibble replacement guarantee. It's never been cheaper to upgrade!



1 Mb Fully populated RAM board... NOW ONLY £34.99 1 Mb unpopulated RAM board £16.99 1/2 Mb inc. clock £29.99

A 600 Phoenix PA 601-populated-1Mb £44.99 Phoenix PA 601-unpopulated-0Mb £24.99 PA 6020 2 Mb PCMCIA card £129.99 PA 6020 4 Mb PCMCIA card £199.99

CHIPS

AMIGA CUSTOM CHIPS Kickstart 2.04 ROM £34.99 Kickstart 1.3 ROM £27.99 Fatter Agnus 8372A £34.99 NEW Super Denise £29.99 CIA 8520A £9.99

MEMORY CHIPS 4 Mb x 9 (-70) Simm £99.99 1 Mb x 4 (-80) Zip £29.99 1 Mb x 9 (-80) Simm £27.99 256k x 4 (-80) Zip £29.99 256k x 9 (-80) Simm £12.99 1 Mb x 1 DRAM £3.99 256k x 4 DRAM £3.99 *This price is for 1 Mb of RAM

These chips cover practically every popular memory expansion or Hard Drive system on the market for the Amiga ie. GVP, SUPRA, MICROBOTICS, COMMODORE

PRINTERS

REGISTERED DEALER FOR STAR • CITIZEN • HEWLETT PACKARD AND CANON

PHOENIX PRINTER PACK Supplied with ALL printers containing 1.8m std. printer cable, printer ribbons/cartridge and 250 sheets of paper absolutely FREE.

STAR LC-100 Colour... NEW! £164.99 9 PIN colour printer with paper parking, eight fonts and electronic DIP switches.

Table listing printers: LC24-100 £189.99, LC-20 £132.99, LC-200 Colour £199.99, LC24-20 £199.99, LC24-200 Mono £219.99, LC24-200 Colour £279.99, XB24-200 Colour £379.99, SJ48 Bubblejet £219.99

CITIZEN Swift 240 Colour... NEW! £264.99 Swift 240 Mono... NEW! £254.99 Swift 200 Colour... NEW! £214.99 Swift 200 Mono... NEW! £187.99 Swift 9 Colour... SPECIAL OFFER £169.99

HEWLETT PACKARD Deskjet-550C (colour printer)... NEW! £559.99 300 dpi laser quality output • sharp blacks and 16 million colours available • six built in type faces-4 scalable • improved media handling • several paper sizes • FOUR TIMES FASTER than previous H.P. Deskjet range.

Table listing HP printers: Deskjet 500... SPECIAL OFFER £329.99, Deskjet-500 Colour £449.99

HP printers come with 3 year warranty. HP black ink cartridge £24.99 HP colour ink cartridge £29.99

Table listing auto sheet feeders: STAR LC20 £57.99, STAR LC200 £59.99, STAR LC24-200 £62.99, STAR LC24-20 £62.99, STAR SJ48 £49.99

BUBBLE JET

CANON BJ 10eX... £214.99 Upgraded version of BJ10e, the worlds biggest selling portable inkjet printer.

CANON BJ 20... £319.99 More Features than the BJ10, includes Auto sheet feeder. Top selling-Highly Recommended

CANON BJ 200... NEW! £349.99 Feature include: 300 dpi. • Min 80 page Auto sheet feeder • minimum 3 pages per minute SUPER VALUE!

CANON BJ 300... £374.99 80 column bubblejet provides laser quality output.

CANON BJ 330... £499.99 136 column bubblejet. CANON Bubblejet cartridges £17.99 BJ 10eX Autosheet feeder £49.99

PRINTER ACCESSORIES We have a large range of high quality printer accessories for all the printers we sell including: dust covers from £2.99 • Ink cartridges from £13.99 • Mono ribbons from £3.50 • Colour ribbons from £7.99 • Printer stands from £7.99

A GREAT DEAL OF QUALITY AT GREAT DEAL PRICES

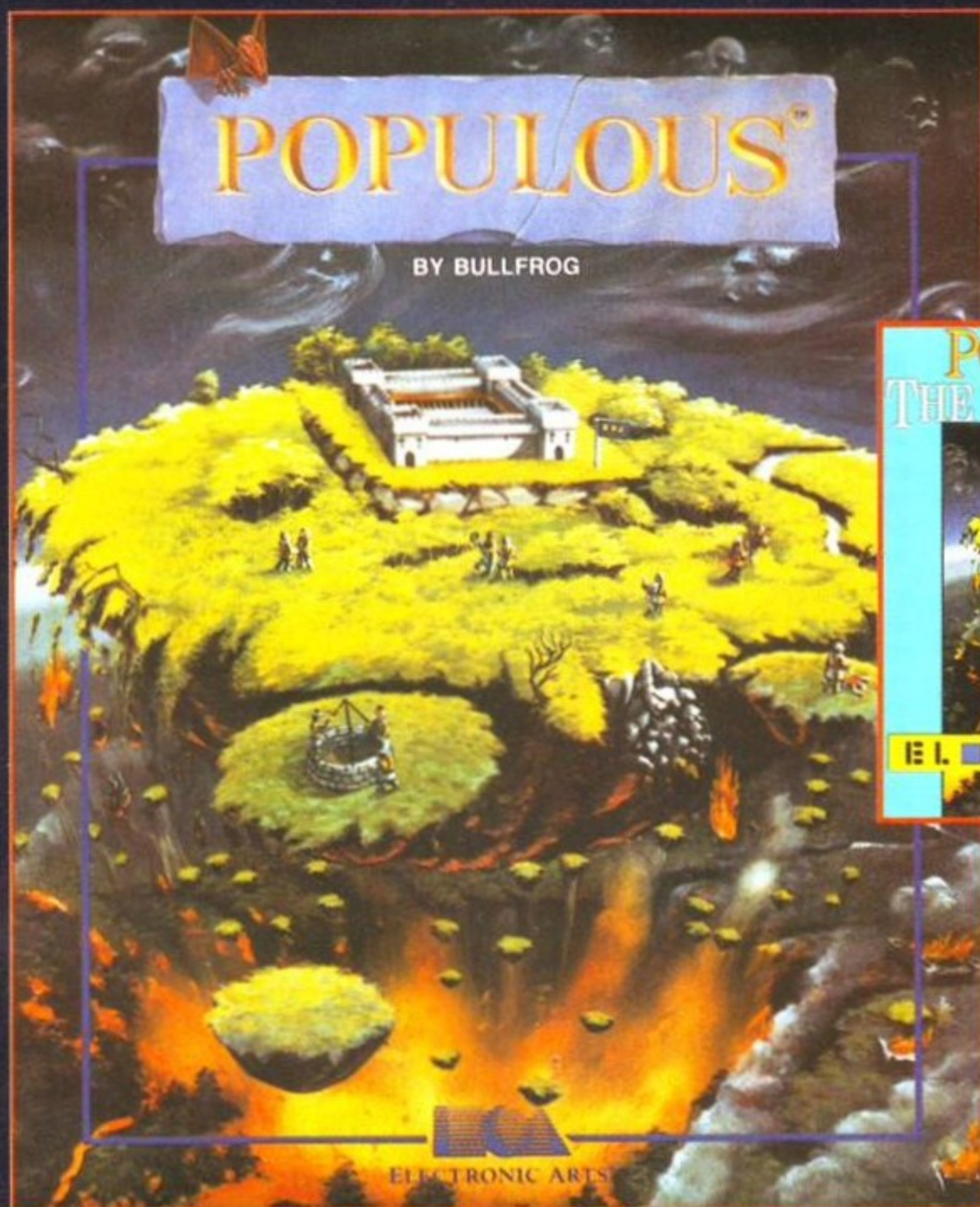

POPULOUS[®]
BY BULLFROG

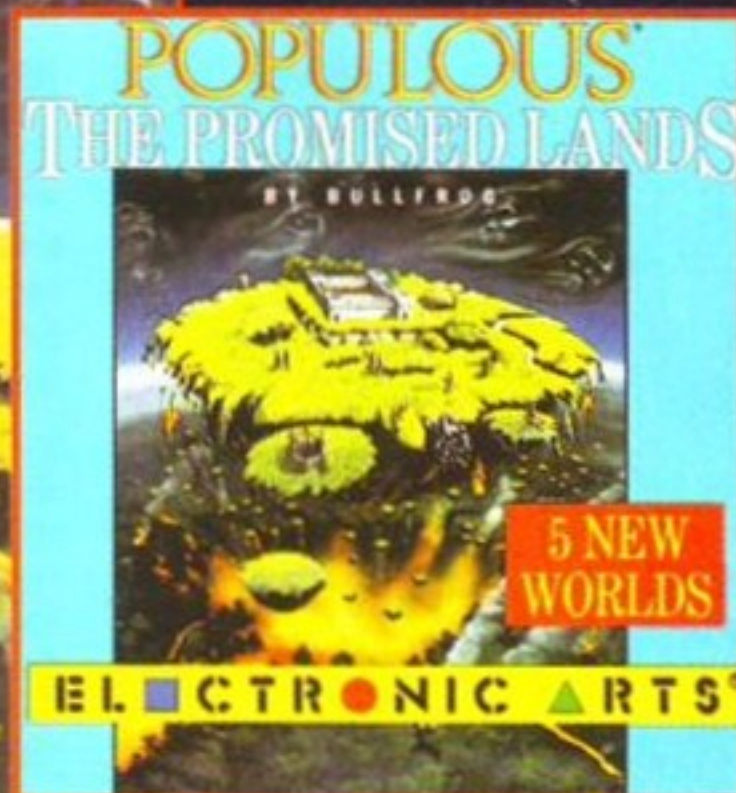

POPULOUS
THE PROMISED LANDS
BY BULLFROG
5 NEW WORLDS
ELECTRONIC ARTS

THE POWER OF LIGHT OR THE FORCE OF DARKNESS... YOU DECIDE!
The all time classic now offered to you complete with the PROMISED LANDS data disk giving you a further five divine new worlds, bringing a new dimension to the legend that is POPULOUS.
PC £14.99
ATARI ST £12.99
CBM AMIGA £12.99



POPULOUS & PROMISED LANDS TOGETHER IN ONE SPECIAL PACK



STRIKE FLEET



4TH & INCHES

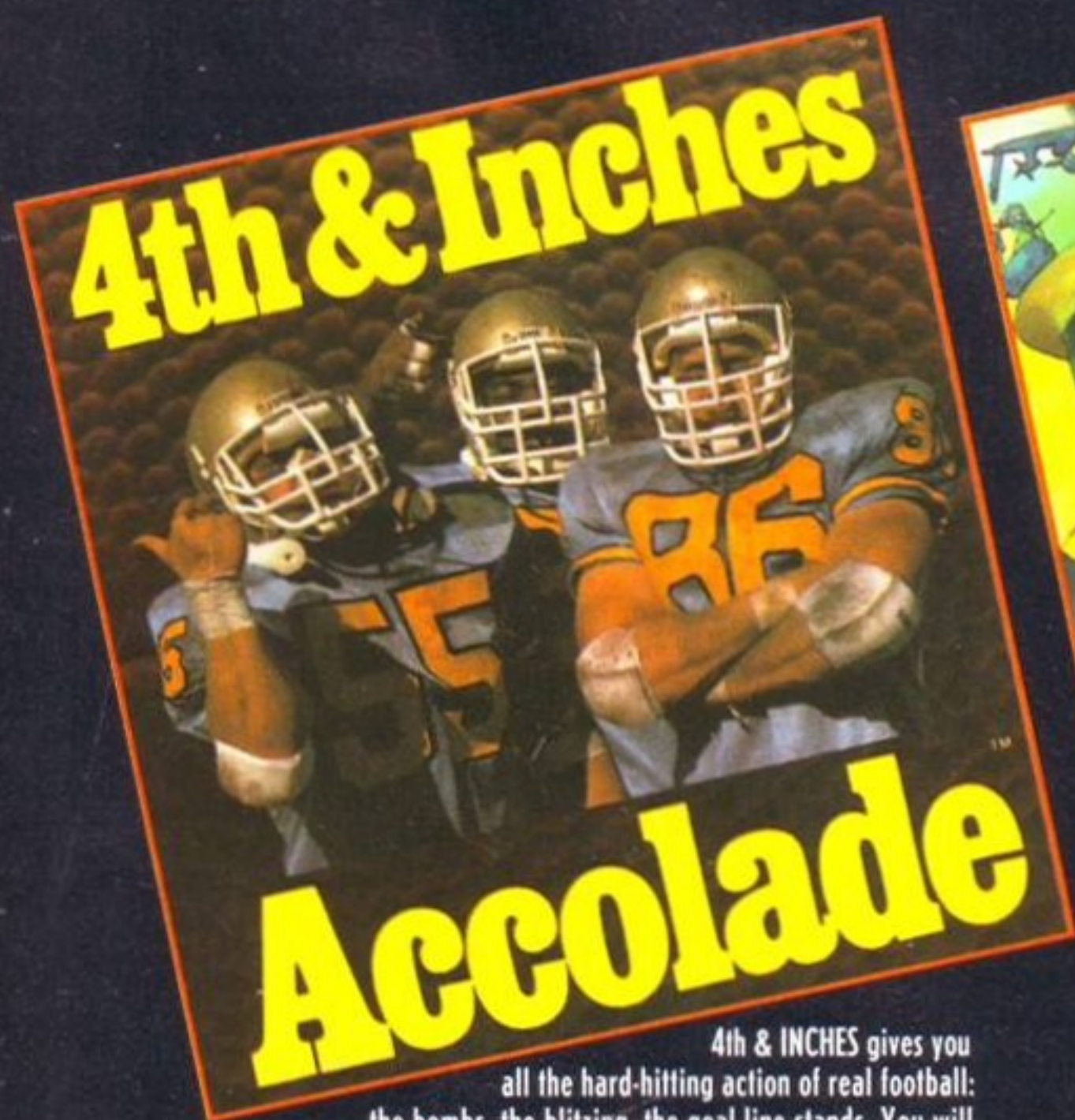

4th & Inches

Accolade

4th & INCHES gives you all the hard-hitting action of real football: the bombs, the blitzing, the goal line stands. You will experience graphics and animation that are as riveting as a blind side hit. This is the big time, hotshot, this is 4th & Inches.
PC £12.99 CBM AMIGA £9.99

© Accolade™, Inc.



STRIKE FLEET

ELECTRONIC ARTS

Experience the heat of modern naval combat. Send out Hi-Tech helicopters for remote targeting or Anti-Submarine warfare. Engage enemy fleets, submarines, long range missile bombers, and land-based missile launchers. Choose from 14 real-time battle scenarios or an 8-mission campaign.
PC £12.99 ATARI ST £12.99 CBM AMIGA £12.99

TM & © 1987, 1988, LucasArts Entertainment Company. All rights reserved.



HIT SQUAD
2 CASTLE STREET
CASTLEFIELD
MANCHESTER, M3 4LZ
TELEPHONE: 061 832 6633
FAX: 061 832 6633

UNLOCK 3D Ray Tracing



RAY TRACING PROGRAMS define the world as a series of points to make up a wireframe model. Then they clad this wireframe with surfaces. The surfaces have properties of colour, reflectiveness and opacity. The user then places one or more light sources in this wireframe environment, and positions a camera to take the picture. The program calculates what the picture should look like by tracing the path the light would take from the lightsource, reflecting off all the surfaces and entering the imaginary camera. The program effectively creates a 3D image by tracing the ray of light!

IMAGINE 2 IMPULSE

£223.25 ■ ALTERNATIVE IMAGE
0533 440041

This is the most acclaimed ray-tracing program. It can create images in full 24-bit that are so life-like it is difficult to tell them from a photograph. The program can texture map images, which means it can take an IFF image of something, like a wood-grain pattern, and wrap this on to a 3D object, giving the appearance it is

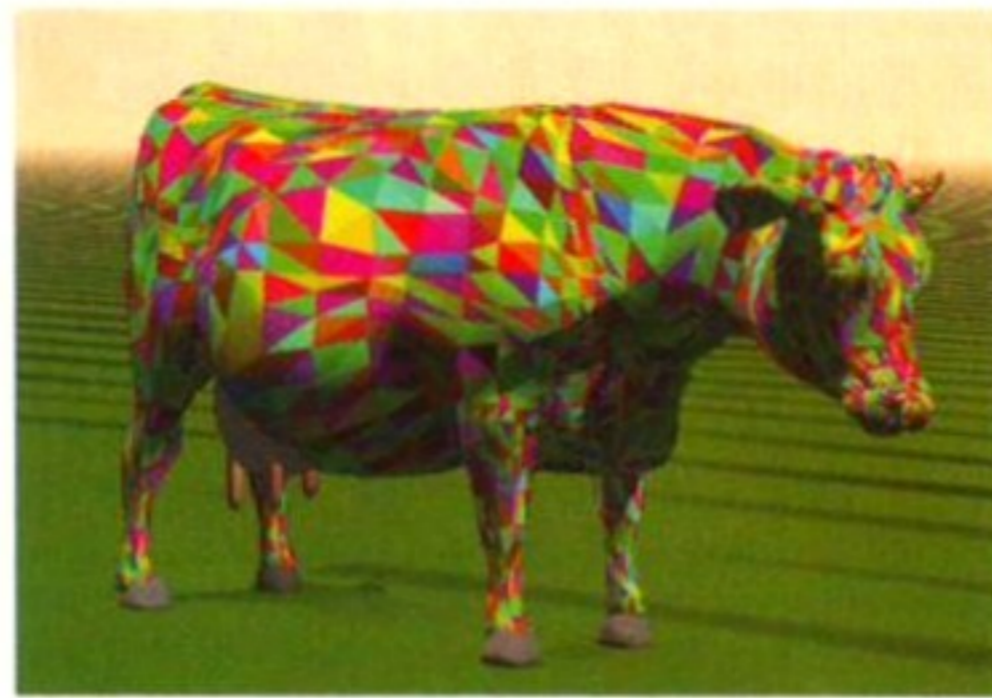

You can create your own world full of multicoloured cows in full, photorealistic true colour with *Imagine 2*.

made of wood. Different objects can have different textures, so a realistic scene can be created.

The maths required to render an image is complex, but the render engine of *Imagine* is quick and gives superb results. An accelerator is recommended however. *Imagine* can create a series of frames with either the camera, the objects or both moving from frame to frame. This makes it possible to create some stunning animations. Because all 3D objects are made up of polygons, it is important that a program can shade the edges of these with respect to the surrounding ones, thus making the rendered image appear very smooth.

REAL 3D

NEW PRICE TBA
ALT IMAGE ■ 0533 440041

Real 3D takes a slightly different approach to *Imagine*, in that most of the objects are created from primitives.

Primitives are triangles, circles, cubes, prisms etc, which are combined to produce more complex objects, or used as cutting tools to remove parts from an object. This approach simulates the way we make things in the real world, by glueing things together and cutting pieces out. *Real 3D* has just become available at a new lower price, and it really is an excellent place to start for anyone thinking of giving 3D ray tracing a go.



Real 3D uses a very different modelling technique from many 3D programs, but to equally spectacular results.

C-LIGHT 2

PUBLIC DOMAIN

The only PD ray tracer worth touching with a bargepole is *CLight2*. Using a system similar to that of *Real 3D*, shapes are built of primitives, which can be distorted to give the desired shape. Images are then rendered to HAM mode pictures. A basic but worthwhile introduction.

Image processing

ART DEPARTMENT PROFESSIONAL

£211.50
DMI ■ 0753 686000



It's ironic that a program that performs wondrous image manipulation should look so drab, but *Art Department Professional's* interface is a bit dull.

ASDG have built a formidable reputation on the back of this program. The file conversion facilities alone make it a product worth possessing, but when you consider the number of other operations that can be performed on an image, it really becomes a necessity for anyone with image-processing requirements. The

interface is simple enough, but a bit clunky for being in low res mode. The true beauty of the program, though, is the modular nature of its loaders and savers. Any format of file can be loaded, if you have the correct loader module. An excellent range of loaders come with the program, and more are available as expansion packs from ASDG. A series of ancillary programs are available, such as *Morph Plus* and various scanner drivers. All these work in the same way as *AdPro* itself, and make use of the same interface.

AdPro can apply a vast array of operators to any Amiga bitmap image, right up to 24-bit resolution. You can scale, flip, convolve, invert, make grey, roll, pixelate or perform one of many more image-processing tasks. When it comes to serious image processing on the Amiga, *AdPro* has no competition.

PERSONAL PAINT

£59.95
MICROSPACE UK ■ 0753 551888

Essentially a 256-colour paint package, *Personal Paint* has burst on to the Amiga scene hot on the heels of the new AGA chip set machines. But underneath the mere paint package exterior, it has some quite impressive image-processing facilities. It is only with the advent of the new Amigas that image processing has really

come into its own. Most image processing tasks simply cannot work in 32 colours, or if they do they cause so much degradation in image quality that it simply isn't worth the time trying them. Resizing and rotating pixel images requires anti aliasing to make the resultant image appear smooth, but if you don't have enough colours in your palette to allow the correct range, anti aliasing cannot work. Now the Amiga can display in 256 colours, *Personal Paint* hasn't hesitated to exploit its new abilities. Full review Page 136.



Despite its painterly name, the area *Personal Paint* really excels in is that of image processing.

UNLOCK THE POWER

Programming languages

These include files that are not hacked versions – they are the official licensed ones from Commodore. If you get the Addison-Wesley books on programming then you will be able to write fully multitasking applications. Lattice C is not easy on the beginner, it assumes you are fairly fluent, and can read C programs. However, if you are not, then there is a set of PD disks called the *C manual* by Anders Bjerin. This intrepid Swede runs the Worldwide Amiga C Club, designed to help budding programmers avoid being bugging programmers. Miss this at your peril.

AMOS PROFESSIONAL £69.95 ■ EUROPESS SOFTWARE 0625 859333 ■

The most powerful version of *AMOS* to date, and many features that were previously only available through *AMOS* gadgets system are now accessible by an extensive range of pull-down menus. Several source code files can be opened at once, allowing the user to cut, copy and paste between them. You can incorporate ANIM format animations into your programs, and play soundtracker modules and MED tunes. A new interface command set enables you to build up screen displays of gadgets, slide bars and requesters, for inclusion in your programs. So whereas *AMOS* was seen as a games-writing language, *AMOS Pro* is more of an all rounder. The inbuilt AReXX support makes the program ideal for constructing multi program environments.



AMOS Professional is the package that will give any Amiga owner the power to write serious programs.

AMOS AMIGA FORMAT 42

The original *AMOS* program is no slouch, and even if it can't compete with the professional version, it's still a capable programming language. When you consider we gave the program away on AF42, and are selling the full manual for £13.95 through our mail order pages (174), this has to be the cheapest way to get programming on your Amiga. We'll be giving tutorials throughout the year to help you get the most from the program as well.

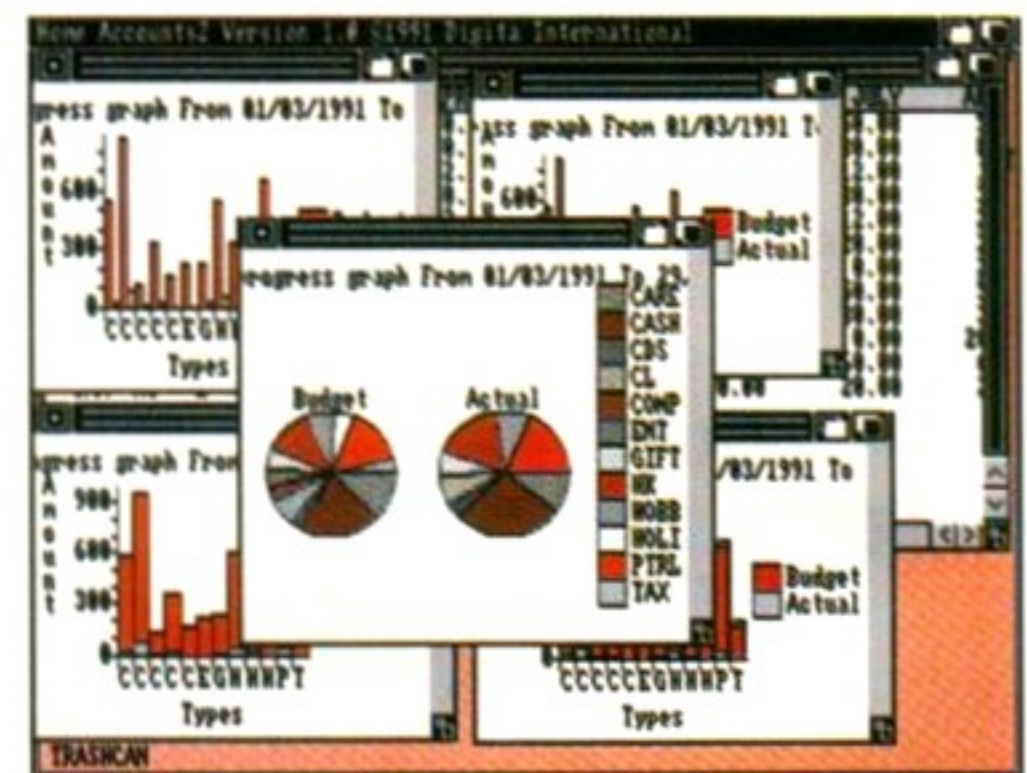

Managing the household budget is a task that *Digitia's Home Accounts 2* eats for breakfast. You should let it at your cheque account.

BIZCALC ESSEX COMPUTER SYSTEMS HOME BUSINESS PACK 1

More of a home-repayment planner than a full accounts package, *BizCalc* is still quite useful for balancing your personal finances. It can accept details of your mortgage, loan repayments and general bills and then calculate a repayment schedule for you. As sold by Essex Computer Systems (0268 553963), it comes in a disk pack with another program designed to help small businesses.

IF YOU FIND you can't get the exact software you want, or if you fancy seeking fame and fortune as a household name in the world of computer gamers, there's only one thing to do: learn to program. There are a plethora of programming languages for the Amiga, some though, stand out as extra special, we'll take a look at those ones here on this page. But beware, programming is never simple, and while programs like *AMOS* make it easy to get started, you'll still need to do a lot of hard work.

LATTICE C VERSION 5 £229 ■ HISOFT ■ 0525 718181

The best Amiga C development system you can get. Most documentation on programming the Amiga in C assumes you own this. It is expensive for one reason. When you buy a copy of Lattice C, you get all the include files for AmigaDOS. That means that you can legally program using the built-in routines of every Amiga (in the Kickstart ROM chip) – and the programs will work across the entire range!

Accounts

SINCE COMPUTERS ARE notoriously good at doing sums very quickly, even quite difficult ones, you might think that your Amiga would be a good tool for keeping the books. And you'd be right. From small business accounts right down to balancing your check book the Amiga has a lot to offer.

PROFESSIONAL CALC £159.80 ■ SILICA ■ 071-309 1111

OK so spreadsheets aren't things to get excited about, but if they were this would be the one to do it over. As well as doing all the important things, like being able to accept lots and lots of rows, columns of numbers and how they should relate to one another, then calculate in a jiffy what all the totals are, *Professional Calc* can also display the information in a variety of ways.

Or more simply, you can give different columns or rows of your spreadsheet different type styles to emphasise the important ones. More impressively you can present your results in a variety of colour on screen graph and pie-chart formats. You can then of course print any of these presentation methods out to your printer. *ProCalc* reads, and indeed writes in Lotus 123 format, which is without a doubt the industry standard for spreadsheets.

This means that any Amiga users wishing to transfer spreadsheet files between their PC at work and their Amiga at home should have no problem at all.

HOME ACCOUNTS 2 £54.95 ■ DIGITA ■ 0395 270273

Not really a spreadsheet program, but *Home Accounts* manages to balance the books all the same. It is basically aimed at the non-professional user, but the emphasis is on user friendliness, and it certainly succeeds. The program aims to help the user balance the domestic budget on household or cheque accounts, but it is powerful enough to handle the accounts of a small business.

It can take account of standing orders, automatically number cheques and tell you when a particular account should have funds added or removed to maximise interest. Everything can be summed up in graph form, and several different formats of graphs can be viewed at once, each one being automatically scaled to fit in its window. A handy interest forecast function can even tell you exactly how much your HP is going to cost. At the price *Home Accounts 2* won't place too much of a strain on your budget if you should decide to buy it.

IT'S ALL WELL and good trying to divide the Amiga's software up into separate areas, but the computer is so flexible that there are always programs that fall through the net. Excellent pieces of software that don't really fall into a category, but which are incredibly useful or interesting in their own right. Here we take a look at some of the best of them...

DIRECTORY OPUS £39.95
CHECKMATE ■ 071-923 0658

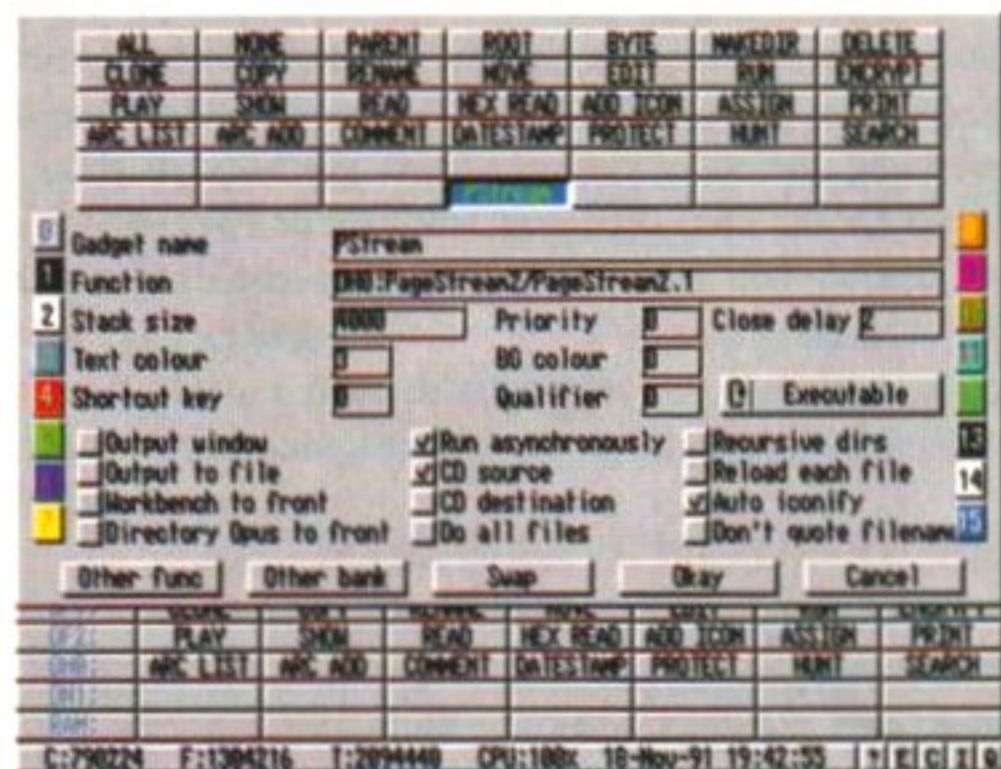

Imagine being able to do all those nasty CLI-type things at the click of a mouse button. Imagine *Directory Opus*.

If you want to get all you can from your Amiga, you absolutely have to abandon the Workbench and dip into the Shell (or CLI) every now and again. Unless you have *Directory Opus* that is. This program enables you to get at all those useful file handling tasks from the safety of a nice point and click interface. You can format disks, copy and delete files all with a few swift moves of the mouse. *Opus* also allows you to view pictures or play samples from within the program, so sorting out what to trash and what to keep on a full disk becomes a doddle.

Another feature is that you can launch programs directly from within *Opus*, and return to the program once you have finished in the other application. All the features are editable, so you can make the program look and work in the way that suits you best, you really shouldn't be without it.

VISTA PRO 2 £69.95
HB MARKETING ■ 0753 686000

Vista is a fractal landscape generator, which means it uses weird maths to reproduce the features of a typical landscape.

Scenes are created by typing in a seed number, which the program uses as the basis of its calculation. Each seed number will produce a unique landscape. Once a basic landscape has been created the user can adjust the water level to create seas and lakes, add rivers and control the heights of the grass, tree and snow lines. The picture is then rendered at a resolution chosen by the user, who also has control of the position of the 'camera' which takes the picture, and the position of the 'sun' relative to the scene.

There are quite a few programs of this type for the Amiga, but *Vista* takes the crown by having more features, more easily controlled than any of the others. Because *Vista* can read files in the DEM format, used by geologists in the USA to record information for use in map creation, it can access the library of landscapes filed by the US Geological Survey. This means you can buy and render real scenes like the Grand Canyon, and Yellowstone National Park. *Vista* is not only interesting and educational, it is a whole load of fun too.

Other goodies

As I write, a new improved version of *Opus*, version 4, has just been released, but the price has not yet been confirmed.

MORPH PLUS £199.99
DMI ■ 0753 686000

You've seen *Terminator 2*, the Michael Jackson video and the shampoo advert, so you know what morphing looks like. It's all the rage in cinema and advertising, but did you know you can do full-colour, broadcast-quality morphing on your Amiga? Well you can if you've got a copy of this, *Morph Plus* from ASDG.

The program shares the same interface as *Art Department Professional*, and can be operated from within that program, but it is also available as a standalone package. As well as doing the obvious owl into a baby and back again tricks, *Morph Plus* can also sherise and ripple images, and apply a good range of image-processing operations. Although the control mechanism is a little unwieldy at times, *Morph Plus* can deliver results that are simply breathtaking.



If you need to convert your girlfriend into a tiger, there's only one way to do it. Use *Morph Plus*.

GB ROUTE PLUS 2
£79.95 ■ COMPLEX COMPUTERS
0706 224531



You don't wanna go round the M25. You wanna take the A666 till Gotlostie, then stop and ask *GB Route*.

If you're planning to take a journey by road, but aren't sure which route will cover the least distance, use the least fuel, or offer the shortest journey time, *GB Route* is the program for you. An extensive database of UK locations is accessible in such a way that all you have to do is type in where you are travelling to, and where from and *GB Route* does the rest.

The program takes account of the miles per gallon you get from your jalopy at certain speeds, plus the rate of progress you can be expected to make on different varieties of road, to calculate the fastest and most economic routes to take. The resulting route plan can be printed out either as a map, or as a list of directions, and taken with you on your journey. Unlike the earlier versions, the latest version of *GBRoute* includes B roads, which means you will be able to take the scenic route, rather than haring along motorways and A roads. All in all, an informative and very useful product.



UNLOCK THE POWER Games

impossible to ignore. While the consoles threatened to take over the games market, this sold more copies than any other piece of games software in the run up to Christmas 1992.

GOD GAME CIVILIZATION

From Sid Meier, author of the excellent *Railroad Tycoon*, comes a game that puts you in control of the entire world. Packed with information, entertainment and gameplay *Civilization* gives you control of the history of the world, and the major civilisations thereof.

You have to nurture society, avoid or fight wars, encourage scientific progress and eventually establish a dynasty that not only controls the Earth, but escapes successfully into space as well. It's a complex game of course, but you'll learn more from playing it than you ever did in history at school, probably. And you'll enjoy yourself to boot.

ADVENTURE/RPG MONKEY ISLAND 2: LE CHUCK'S REVENGE

Following hot on the very successful heels of *The Secret Of Monkey Island*, *Monkey Island 2* is more of the same. But when few thought it could improve on the gorgeous look and humorous gameplay of its predecessor, that's exactly what it did. Taking graphic adventures to new heights, this game will have you sat over your Amiga cursing the ingeniousness of Lucas Arts' programmers. And when you finally solve all the puzzles, collect all the items and complete the game, you'll be waiting eagerly for the sequel. Though the game spans 11 floppies, even non hard-drive owners will find there isn't too much disk swapping.

FLIGHT SIMULATION F-19 STEALTH FIGHTER

Based on America's super-secret, ultra-low radar signature stealth technology, *F-19* manages to get an action-packed flight sim into the box along with all the hype. But what else would you expect from MicroProse? For excitement value alone it is untouched in the flight sim stakes. Charged with a wide range of missions, it's your task, true to the stealth ethic, to get in, deliver your armoury with pinpoint accuracy and get out again – all completely

undetected by the enemy. Though you may suspect that they will get a clue about your existence when the bombs go bang.

SPORT SIMULATION PGA TOUR GOLF

Now getting a bit long in the tooth, *PGA* is still unrivalled for sheer playability. Sure the competition have put up some very worthy contenders, *MicroProse Golf* and *Links* both had what it takes to cut the mustard, but *PGA* just soldiers on as a completely addictive old fave. Whereas Virgin's *Snooker* excited all who'd ever been near the green baize, *PGA* makes total mouse wielding addicts of people who've got a sworn abhorrence for the club swinging activities of Faldo and co. A simple, but demanding control mechanism and a good range of courses keep you coming back time after time. And once you think you're good enough, there's always the tournament option to test your mettle.

DRIVING GAME FORMULA ONE GRAND PRIX

The Amiga has driving games aplenty. Some are great, and some are crap. Most are third-person perspective, sprite-based screamers like the perfectly respectable *Lotus 2*. But one game stands head and shoulders clear of the rest. *Formula One Grand Prix* is what few games have had the guts to be, a driving simulator. Not only do you have to be able to find the line round some of the world's top racing circuits, but you need to know what tyres to use, when to change them and what suspension set up is right for the day if you hope to keep Nigel Mansell away from the champs.

PUZZLE GAME LEMMINGS

All right, so everybody's got it! But if there's anybody out there who by some cruel twist of fate has managed to avoid getting a copy of *Lemmings*, go out and get it now. We know that it has become a bit of cliché to recommend it, but it really is very, very good indeed. It's the kind of game that you sit down to 'have a quick go on' just before bedtime on the evening before the most important interview/exam/wedding day of your life, and find yourself still playing as the sun comes up the next morning. If you miss this game, you are missing one of the most important cultural events of our age.

SHOOT-EM-UP SWIV

This vertically scrolling, helicopter and jeep, two player blast is the viewed-from-above descendant of *SilkWorm*. There's so much going on that it's hard to believe that the screen doesn't slow down. But it doesn't, it just keeps blasting away, with a frighteningly large amount of baddies and bullets filling the air at all times. Although it's effectively one huge level, using Storm's patent dynamic loading system, there are some huge and fearsome end-of-level guardians. Alas, the ultimate shoot-em-up isn't Kickstart 2/3 friendly.

ARCADE PLATFORM ZOO

So fast it'll make you feel sick, but smooth and playable at the same time, *Zoo* is the platform game to end all platform games. Bright, colourful graphics and well-developed gameplay combine with breakneck speed in Gremlin's, dare we say it, *Sonic* beater. In terms of gameplay, there's nothing new here, it's a run, shoot, punch, collect, beat the clock and the end-of-level-guardian affair. But while it breaks no new ground it does what it does with so much panache it is



This is your Special Weapons Interdiction Vehicle. Now take it for the shoot-em-up of your life in *SWIV*.

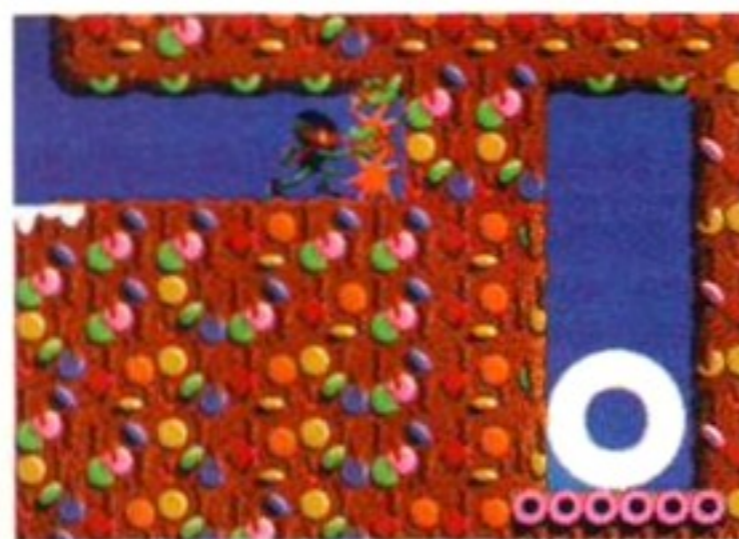

Hidden bonuses, spikey nasties and a secret shoot-em-up level are some of the surprises in store for you in *Zoo*.



Hi, my name's Napoleon and I like the theatre, reading, walking in the country and subjugating the peoples of Europe.



Lucas Arts set themselves a tough act to follow with *The Secret of Monkey Island*, but somehow they improved on it.



Attention to detail and bags of gameplay make *F-19* the Amiga pilot's favourite.



Why go a good walk when *PGA Tour* can improve an afternoon's vegging.



More of a unique driving experience than a game... it says here. *F1-GP* – It's good.



Lemmings is without a shadow of a doubt, possibly the best Amiga game ever.

INTERNATIONAL RUGBY CHALLENGE™

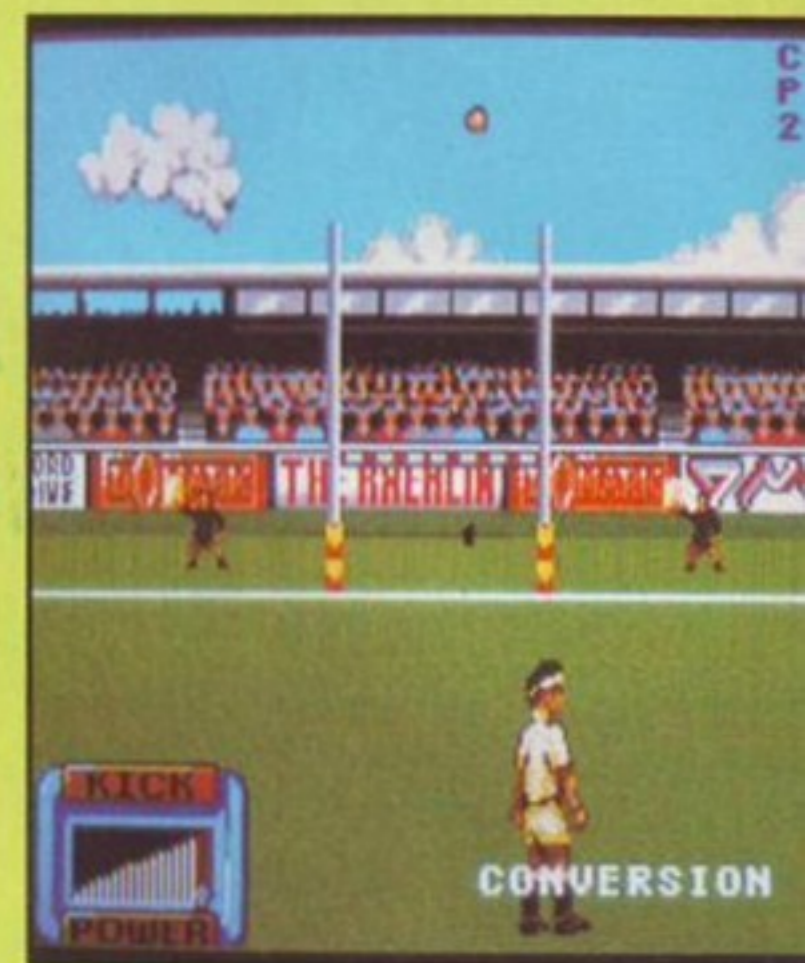

**THE
DEFINITIVE
RUGBY
SIMULATION**

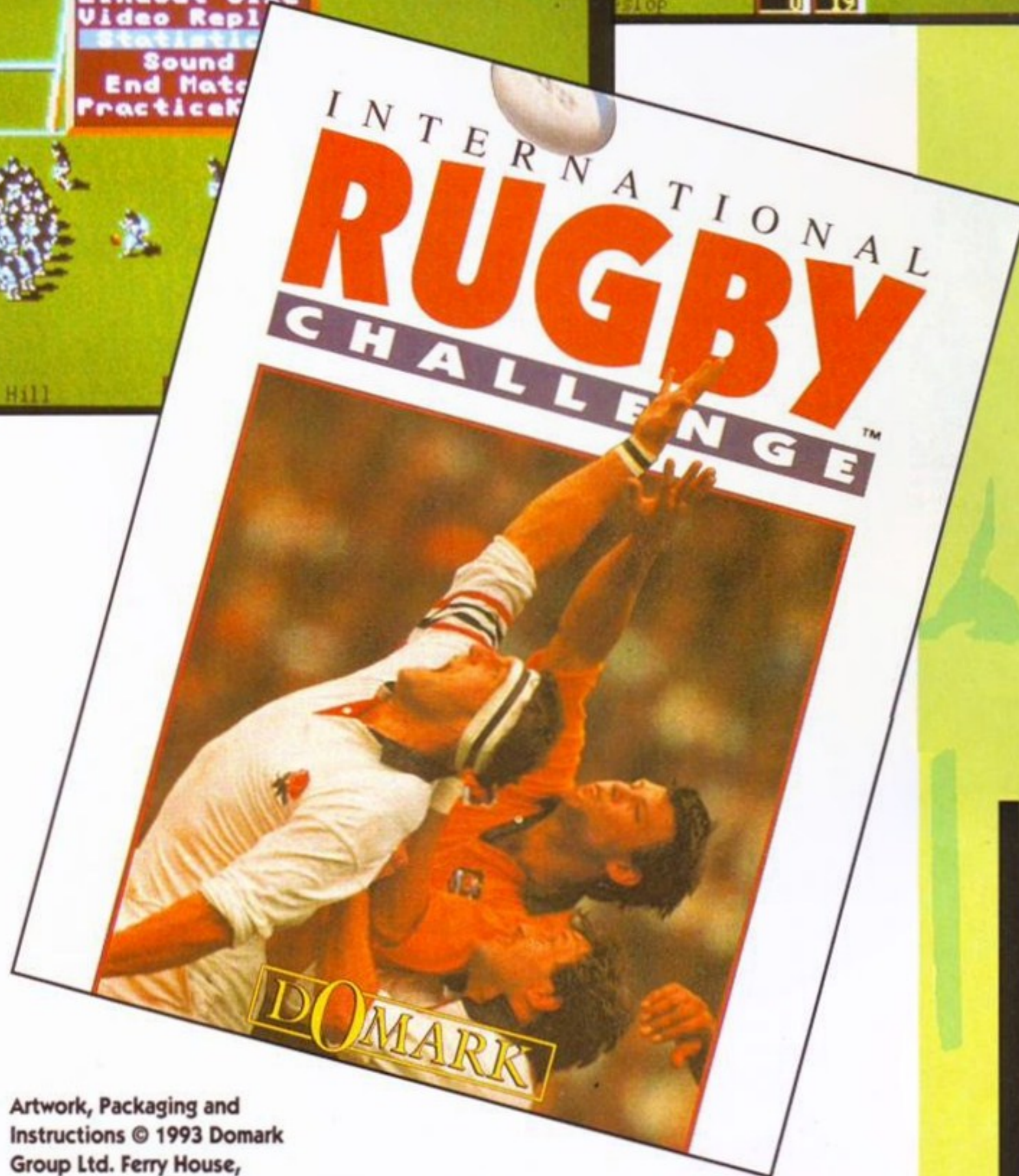
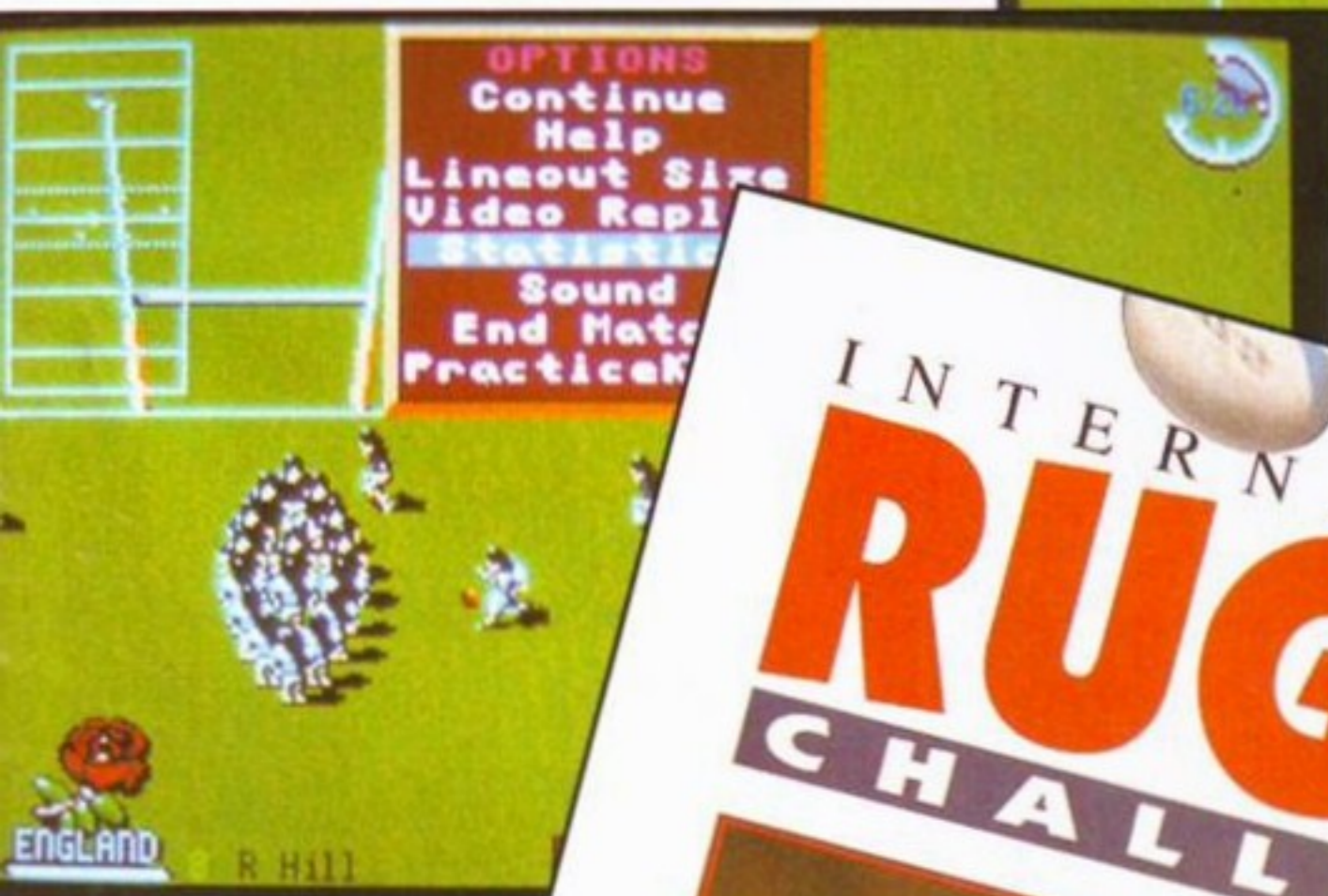

Artwork, Packaging and Instructions © 1993 Domark Group Ltd. Ferry House, 51-57 Lacy Road, Putney, London SW15 1PR. Programming by Oxford Mobious. Produced by Kris Hall and Nathaniel Wilson.

DOMARK

IBM PC Screenshots

Bewildered? Confused? Constrained?

Girl: Oh dear Daddy, how can I move all my IFF files from the root directory of my IDE HD to a floppy using the CLI?

Dad: Ermm??!



Would you like to do damage to people who keep on telling you amazing things about the Amiga?



Do you know your beat-'em-ups from your shoot-'em-ups? Or for that matter from your god-games?

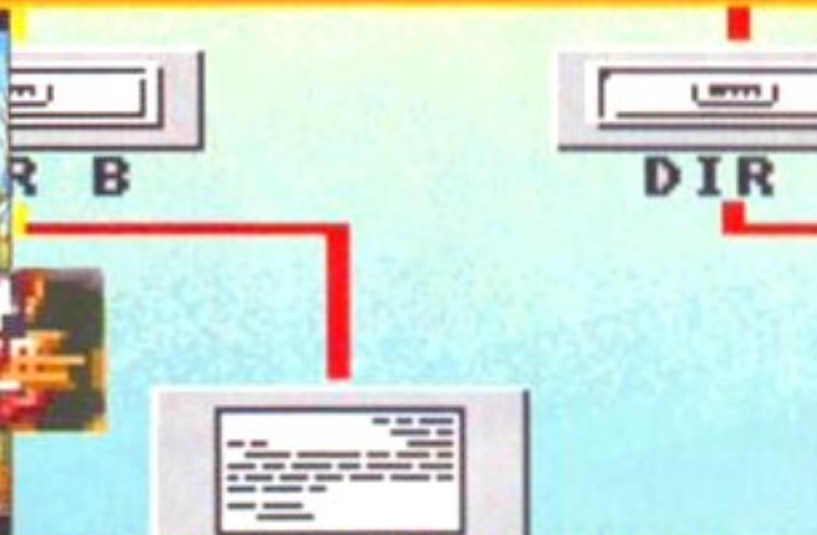

Well, think that it's about time you did know your 'serious' software, your games and your hardware...

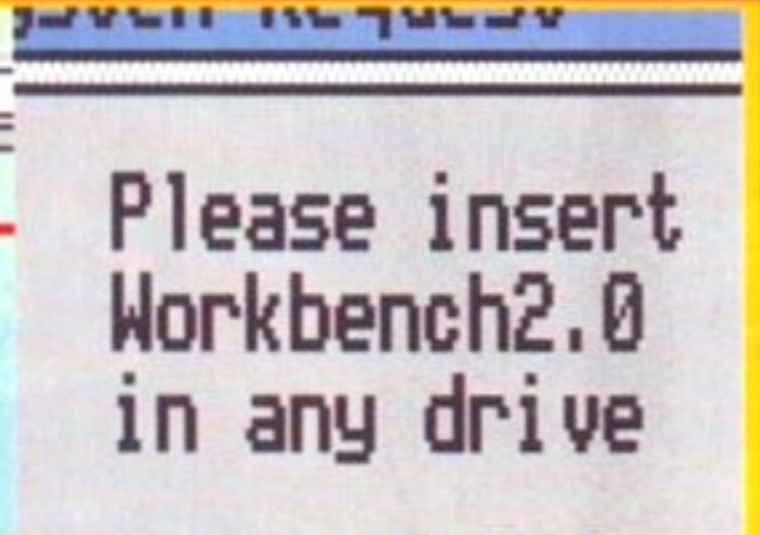

...and within the pages of The Amiga Format Encyclopaedia we'll explain what Workbench is...

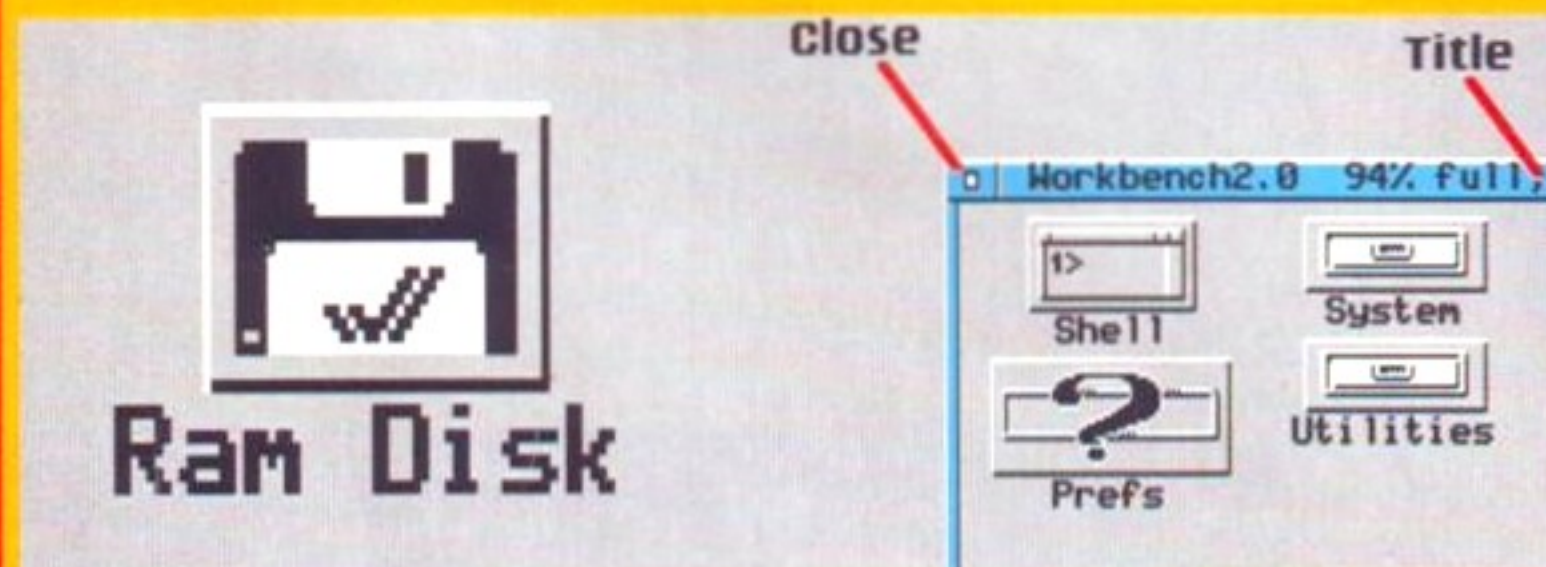

...what exactly a RAM disk or for that matter any kind of disk (floppy or hard) call us over zealous but...

...we'll even explain the entire Amiga range to you, who invented it and why it's called an Amiga...



Oh and we'll also bung in lots of amusing stories about men called Jeff, chips called Denise...



...and lots of information about software companies. It's going to be a blast, thank you for listening.

The Amiga Format Encyclopaedia is on-sale

You won't be for very much longer...

AMIGA **FORMAT SPECIAL**

**Nobody knows everything,
but you could get close, if
you read...**

The Illustrated Encyclopaedia of the Amiga

(and it's all for under four notes!)

from March 4, and is priced at £3.95

"ARTIST ON HOLIDAY"

WICKED TOYS FOR WICKED BOYS

Our A1200's are also available with fully prepared and formatted internal IDE hard disk drives. Please add the following prices for the size of the disk drive that you require:-

20Mb	£110.00
40Mb	£179.00
120Mb	£279.00
240Mb	£449.00
330Mb	£579.00
480Mb	£879.00

PHONE FOR PRICES OF PCMCIA CARDS AND OTHER HARDWARE

FOR PHONE/FAX ORDER SERVICE OR ENQUIRIES

Tel:- (0736) 331039

FOR MAIL ORDER SERVICE:-

**SOFTWARE DEMON LTD,
P.O. BOX 90, PENZANCE,
CORNWALL TR18 2SP**

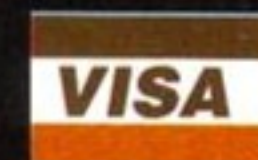

Please add £6.00 for postage & packaging.
Please make all cheques/P.Os payable to SOFTWARE DEMON LTD,
if applicable please include your credit card No. and expiry date.

PRICES SUBJECT TO CHANGE WITHOUT NOTICE. E&OE. ALL TRADEMARKS ACKNOWLEDGED

You will be amazed at the convenience hard disks offer over floppies. No more disk-swapping hassle with big games, no more waiting for Workbench to load so that you can get at your serious programs. But what sort of hard drive do you need? Well that's where **Pat McDonald** comes in, to tell you what best suits your requirements, and review five new models...



Saving-time machines!

AMIGA FORMAT

45

MARCH 1993

A **HARD DRIVE** may seem like an expensive luxury, and sure, they're not cheap, but once you've used one, you'll stop thinking of it as a luxury, and start to see it as a necessity. Hard drives make it so much easier to use your machine as a serious creative tool. They can store Workbench – so you don't have to wait five minutes to get at your serious programs – it's more like 15 seconds. Hard drives load and save far quicker than floppies – typically 30 or 40 times quicker.

If you're a DTP fan, you can store many more fonts, and get easier access to all of them if you have them installed on a hard drive. In fact some DTP packages, most notably Gold Disk's excellent *Professional Page 3*, won't work at all without being

installed on to a hard disk. And we don't have to tell you how much space you need for storing bitmap graphics, especially if you are starting to get into the exciting field of 24-bit imagery.

If you've ever had to go through an extensive floppy based software collection and install a printer driver on all the applications disks, you'll know what a chore it is. If not let me tell you: "It's one hell of a chore." Of course, hard-drive owners only have to do it once, so don't keep wondering why they look so smug.

If you're more into games than serious packages, you'll still get big advantages from a hard disk. Many multi-floppy games, like the wonderful, but let's face it

a bit disk swappy, *Monkey Island 2*, will now install on to hard disk – removing disk swaps and letting you get on with some serious gaming. And a quick look at the latest adventure games will tell you, they are getting bigger, not smaller. But consider this, if you get a 13-disk game, and you have a hard drive, you only ever have to do 13 disk swaps.

If the Amiga is ever to be taken seriously as a computer, more users are going to have to get hard drives. You don't see PC or Macintosh users struggling to run their systems on one floppy drive, so why do people accept it in the Amiga world? OK they aren't cheap, but believe us, they are worth it. Read on...

GREAT VALLEY PRODUCTS!

The best make of hard drive for the Amiga is still GVP Series II. For the A500, the HD8+ A500 is absolutely brilliant – the fastest, best made, most durable and most convenient. Having the game/drive switch (for disabling the hard drive) at the front makes it easy to keep the hard drive out of the way when you don't want it. The matched casing is exactly the same as the A500. A2000/A1500 owners should check out the HD8+ card – the same guts on a different board but without a case.

However, GVPs are imported and so are rather expensive. Also, the occasional duffer finds its way into the market place (over-loud cooling fans are the chief complaint). The manual, while miles better than that of any other drive reviewed here, is confusing for beginners.

If you want the best drive in an imperfect

world, stick with GVP. They are expensive (the A530 accelerator version incredibly so) but worth it. Oh yes, don't worry too much if you get one with a Maxtor rather than a Quantum drive – the designs of the two different makes are much closer than the physical appearance suggests.

Since GVP got serious about the Amiga, they have grown to be the biggest third-party manufacturer for the machine. I could be wrong about this, but I was informed that sales of Commodore's own A590 hard drive took a severe dent when the HD8+ was released. Since then, GVP have made accelerator cards, genlocks, sound samplers and 24-bit true colour graphics cards. The Amiga market is lucky to have them around.

If you want more information on GVP products, or some hardware, phone Silica on 081-309 1111.



The A500 HD+ isn't just a pretty face. It uses state-of-the-art components for unrivalled speed and reliability.

Reference 40/100

Evesham Micros ■ 0386 765500 ■ £229

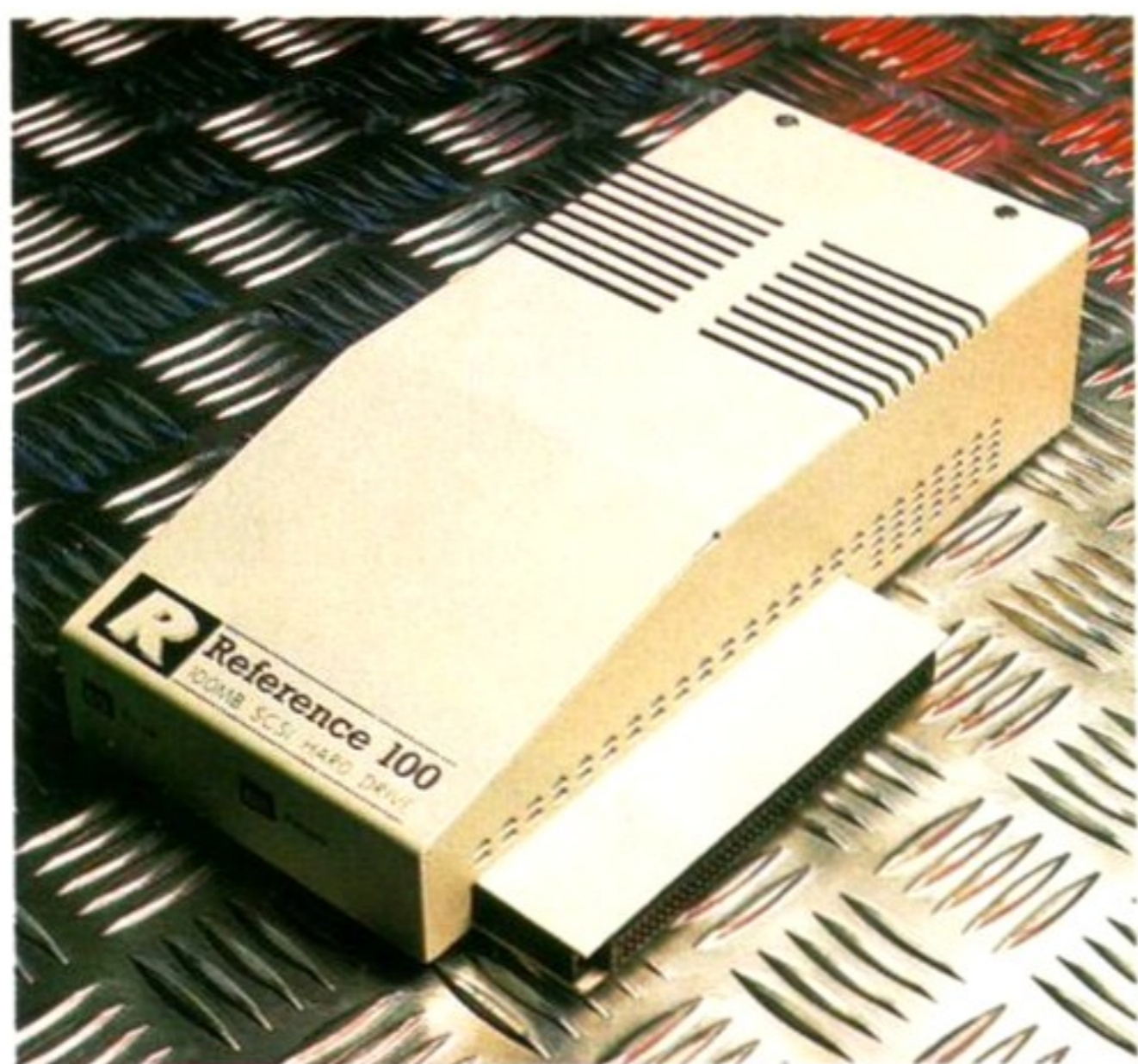

AMIGA FORMAT

46

MARCH 1993

ONE THING YOU can't appreciate by just looking at this hard drive is how tough it is. The casing gives the impression it's built like a tank. It certainly is heavy, but sadly not scratch resistant. A powerpack is supplied as standard – it's the Zydec A500 replacement. So you could use your present power supply unit on the hard drive, and use the pokey PSU on your Amiga.

As standard, the Reference can take SIMMs (Single Inline Memory Modules) to give far faster RAM to an A500 (the A500 Plus has no fast RAM at all as standard). With a hard disk, it's a very good idea to have some fast RAM, because the hard disk takes memory away from the system – about 90K per partition. Which means, a 1Mb Amiga with a hard disk would not be able to run a lot of 1Mb software – because the hard disk takes just that little bit of memory that the 1Mb program needs to work.

You can plug either 512K or 1Mb SIMMs into the Reference. There are four SIMM sockets, which means a total of either 2 or 4Mb – not as much as a GVP controller, but

The Reference is available in 40 or 100 Mb sizes. Although not elegant, it has a certain rugged appeal.

more than an A590. If you need the full 8Mb of fast RAM capable on an A500/A500 Plus, the Reference is not for you (I certainly don't need that much). The memory autoconfigures, which means that your Amiga recognises and uses it as soon as you switch on. A game switch is fitted. This drive is available in two versions – the 40 Mb for £229, and the 100 Mb for £299.

Getting started with the drive is tricky compared to other units – the drive is unformatted and has no Workbench on it. Evesham are sticking strictly to the letter of the law (Workbench is copyrighted to Commodore) but the manual makes it fairly clear how to get up and running – although the layout is naff, all the information is there. If you want to be able to use Workbench 1.3 and 2 (you have the chips and a ROM sharer) then the manual deals with how to do it very simply indeed.

Which brings us to the setup software. At first glance, this looks and feels very amateurish (it was written with *CanDo 1.6*). However, when you move the mouse pointer to the different on-screen buttons, a little help screen at the bottom informs you what each one does. Because it was written in *CanDo*, the setup software is pretty slow – but I think that's a bonus, because you have time to make decisions, and you don't want to rush setting up a drive (you don't want to do it like that!).

Although the Reference is a SCSI drive, with a 25-pin SCSI on the back, it does not

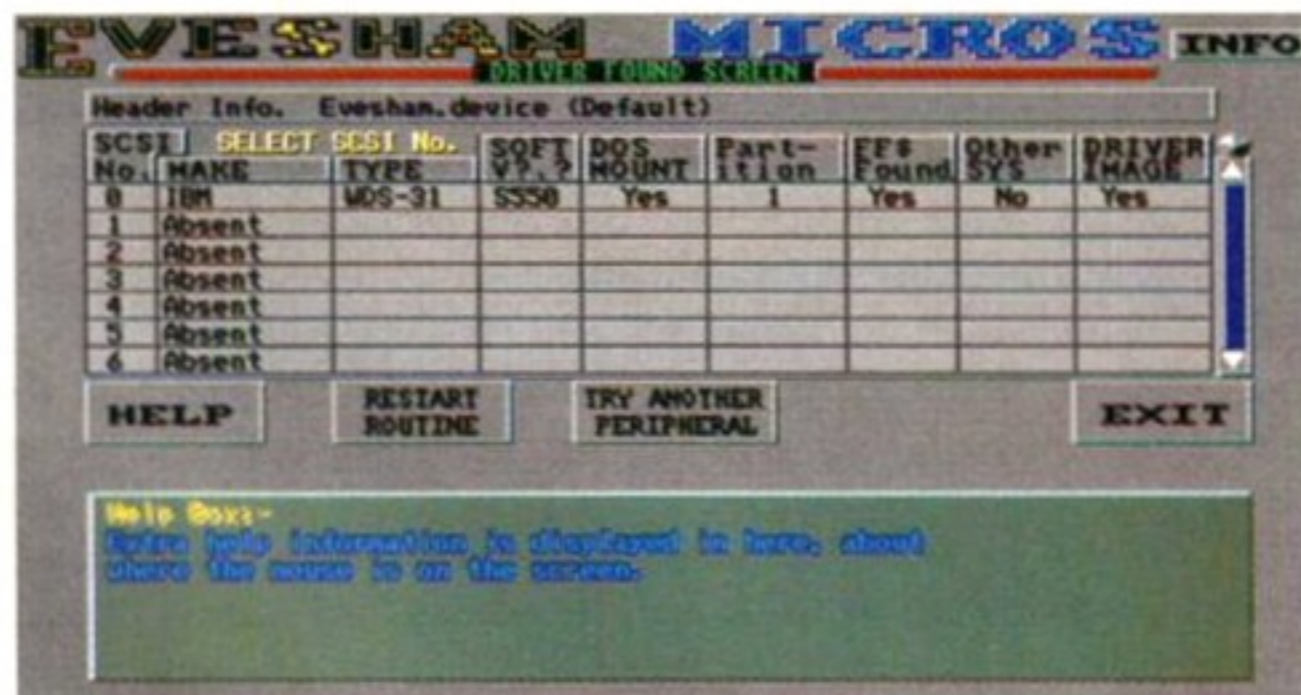

This is the start screen of the Evesham setup software. It does a scan for any external SCSI devices – but if you didn't get them from Evesham, forget it!

SCSI – THE BEST!

Small Computer System Interface, mate. You know you can plug one external floppy drive into another, forming a chain? SCSI is much the same, but can transfer information much, much quicker. It's ideal for connecting extra hard drives to your system, and a hard drive with a SCSI is much more expandable than one without such an interface.

The story doesn't end with hard drives though. A whole plethora of extra devices, from magneto optical drives, through scanners, to tape streamers, can be connected to your system. Admittedly, a lot of this equipment does not have any Amiga driver software yet – but the range will continue to grow, not shrink.

SCSI is relatively expensive. It allows for up to seven devices to be connected at once – that means

the electronics have to be a bit sophisticated to work out who is talking at one time. On the other hand, hardware prices are always coming down.

A SCSI drive is an investment. Although you may never need it, if you ever do come across some cheap SCSI gear, wouldn't you like the option of using it? And if you ever need lots of storage space for writing CDTV titles, SCSI is the only game in town.

But the story doesn't end there. A replacement for SCSI, called SCSI2, is finding high favour with the people able to afford it. Essentially, it's the same thing, only much faster (five to eight times faster) and with more potential (many more external devices). If you are a really serious user, wait for the SCSI2 boards for the A3000, A4000 and – if it comes out – the A5000.

support SCSI units from other computer systems – it cannot perform low level formatting. This is not such a problem since Evesham do a reasonable selection of external SCSI hard drives. Also, low-level formatting "will be included later on", according to Evesham techie Mr Vignoureux.

That's one good thing about the drive – the technical support. Evesham have actually won awards for this. Does this mark a gradual change of crap UK technical support towards the excellent technical support provided by US companies? I certainly hope so.

Apparently, there are two reasons why the Reference drive will not low-level format. Firstly, the software was written by a PC programmer. Now, in the IBM PC world, everybody buys hard drives that are already low-level formatted. So putting the feature in seemed pointless. The other reason is that Evesham do sell external SCSI drives, and naturally they low-level format them for the Amiga at the shop. So it seemed unnecessary to put in a routine to do low-level formatting.

All would be well if you could take a PC low-level formatted hard drive and plug it into an Amiga. You can't. Amiga hard drives have to have an RDB (Rigid Disk Block) written on the hard disk – if they don't, then the Amiga can't make head nor tail of them. It makes you wonder what planet programmers live on.

Part of the reason for this incompatibility is that on the IBM PC, you can only have file names that are eight or less characters long. Amiga file names can be longer than this, so in this case IBM compatibility would have been a giant leap backwards.

The good news is that the problem with the hard drive is software based – with a different piece of set-up software on a floppy disk, it could do low-level formatting. Upgrades for existing owners will be available.

To finish, the Reference is a bit slow at booting up (getting started) but reads and writes information at a respectable rate. It compares favourably with GVP products on price and ease of use of the setup software, although until it can low-level format it will not be in the same league. Relatively easy on beginners, decent memory – it's a winner.

Reference 40/100

SPEED ●●●

Bit slow on booting, but all right once it's started up – maybe it needs winding up?

DOCUMENTATION ●●●

Good content, done in the right order, but very poorly laid out.

ACCESSIBILITY ●●●●●

Excellent setup software – you get a free backup utility too!

FEATURES ●●●

No low-level format yet, but it's in the pipeline for the next few months.

VALUE ●●●●●

Very attractive indeed – you get a good deal for a decent drive.



84%

DESPITE SEVEN YEARS of multitasking operating systems, digitisers and sound samplers, despite five years of 24-bit graphics boards, despite even three years of CD technology, most people who work on large computer systems still think of the Amiga as a games machine. How, they argue, can you store really big applications, like artificial intelligence databases, or local authority records, or whole feature films on an Amiga? Sure, you can store it on CD. But you can't read to a CD, can you?

Enter the Magneto Optical drive. The best way to think of this box is as a floppy disk drive that you plug into a hard drive SCSI controller. The difference is that you can store 120 Mb of information on each disk. Although the unit costs serious cash – each disk costs £35 – it works out cheaper, in terms of price per K stored, than using floppy disks!

This drive is a cross between a hard drive and a CD drive. The data is stored magnetically on a disk, just like a floppy disk. However, rather than using a magnetic head to write the information, it uses a laser beam to heat up the surface of the disk. This means two things – you must still keep the disks away from magnetic fields (loudspeakers, TVs, power supplies); and also you have to use the drive in a clean environment. Smoke and dust can seriously screw it up.

Getting it going is time consuming but not too difficult, if your SCSI hard drive can low-level format (put a Rigid Disk Block, or RDB, on to) a disk. It must also have a 25-pin SCSI port – the vast majority of SCSI hard drives have

Magneto Optical

Power Computing ■ 0234 843388 ■ £999.95

This unit looks pretty ordinary, but under the bonnet it's seriously high tech. The internal version for £799.95 is a much better buy.

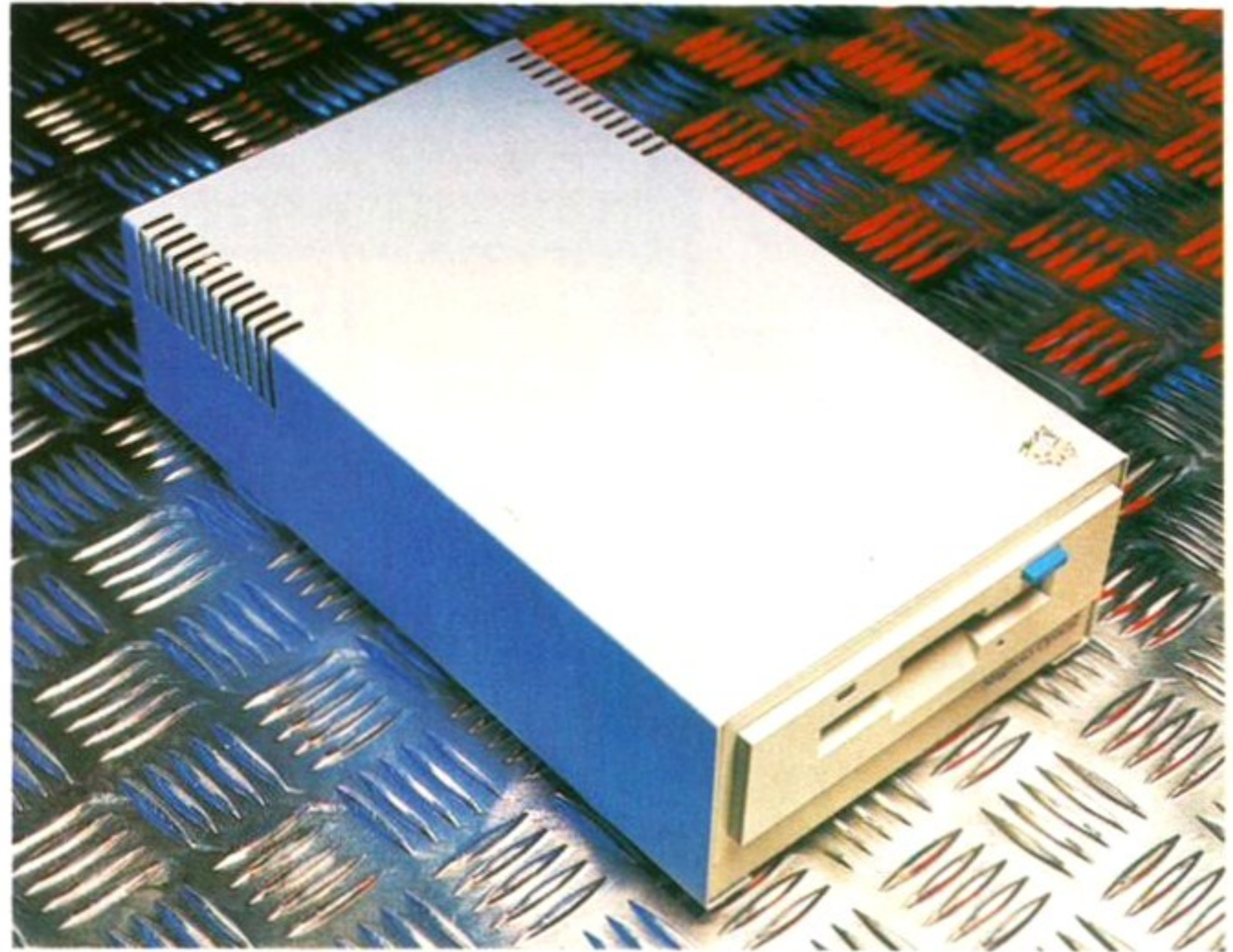

The only bugbear with this unit is that you have to format the disks first – which means looking at this screen for about 35 minutes. Never mind!

this feature. It's easiest with GVP's FaastPrep, but can be done with most other systems, including Commodore's A590 and the A3000.

When you boot up your system, it's wise to have a disk in the drive, otherwise it can get a bit confused. The drive has a powered eject, which looks very swish and hi-tech. When you take out the disk, some controllers will not change the icon, so it will get very confused when you put a different disk in.

There are two solutions to this; you can use the AmigaDOS DiskChange DHXXX: command to tell the Amiga that the disk has been changed; or (if you have Workbench 2) then you can use the supplied shareware *SCSI-Mount* utility. Later GVP controllers do not exhibit the problem – to be honest, neither does my rather old prototype GVP controller.

If you have an A1500, A2000 or A3000T, then you can fit the cheaper internal version in the 5.25-inch drive bay – assuming you don't already have something there. The difference in price is significant – £799 as opposed to £999. I never knew metal boxes, power supplies and connectors were so expensive.

The supplied documentation is rather good. There's not that much to explain about the drive, but it does tell you, step-by-step, how to get the drive recognised and formatted using Commodore's own *HDToolbox*. It also gives a fairly minimal trouble-shooting guide. Not brilliant, but there are so many different Amiga SCSI controllers that it would be a task and a half to do this for all of them.

All things considered, this is an expensive but viable solution to the needs of people who need lots and lots of storage space. I just wish I had the cash to afford one.



FLOPTICAL ALTERNATIVE!

If you haven't got £999 to splash on a magneto optical drive, there is a cheaper alternative. The Floptical drive from DMI (recased and rebadged by Power Computing) weighs in at £389 for the external version, and £289 for the internal version. You need a special slimline internal version for the A3000, but you can put this drive into any drive bay.

Setting it up is just the same as its big brother – you need a SCSI controller that can low-level format. Although this drive is cheaper, the disks are more expensive (in terms of storage space versus price) – they cost £25 each for 20 Mb of storage.

Don't be put off – one useful trick of the Floptical is that it can use standard HD (High Density) floppy disks, as well as the special 20 Mb variety. Drivers for the A-Max Mac emulator are available, and *CrossDOS* can be setup to format standard HD PC disks for those who want to swap big files with real PCs.

It's a tad slower than the Magneto Optical, but it's still about 10-times faster than using floppies. Seriously good if you have the readies to pay for it – I want one! I want one!



Looks like a floppy drive with a power socket in the back.



80%

Magneto Optical

SPEED	●●●●●
35ms access time – average for a hard drive, very good for a Magneto Optical unit.	
DOCUMENTATION	●●●●●
To the point, fairly simple, with just enough techie bits for the enthusiast.	
ACCESSIBILITY	●●●●●
Should work with just about all SCSI controllers that can low-level format.	
FEATURES	●●●●●
Want infinite storage? This is the unit if you have megs and megs of data.	
VALUE	●●●●●
Good for the internal version – external is £100 too much, in my opinion.	

95%

125 KINGSWOOD, THORPE MARRIOTT, NORWICH, NORFOLK NR8 6UW

(0603) 261060

BattleAxe

WE PROMISE YOU GUARANTEED 1st CLASS SERVICE
WE GUARANTEE QUALITY ERROR AND VIRUS FREE DISKS
WE OPEN TILL 9PM TO PROCESS YOUR ORDERS
FRIENDLY TELEPHONE ADVICE WHERE POSSIBLE
ALL ORDERS RECEIVED BEFORE 3PM ARE DISPATCHED SAME DAY BY FIRST CLASS POST

PRINTER PACK

Print just about anything with this pack. Graphics, Letters, Envelopes, Disk Labels, Video Labels, Cassette Labels, Banners, Forms and more also loads of drivers

£6.50

MUSIC PACK

MED V3.2, THE GREATEST MUSIC MAKER + 4 DISKS FULL OF INSTRUMENTS, BEATS etc... TO GET YOUR REMIXES GOING!! £6.50

BITS & PIECES

SPECIAL 1

100 Cap disk bank inc 10 Branded blank disks, A mouse mat and a disk drive, Head cleaning kit

£15.99

Books you MUST not go without!!!

Amiga C for Beginners	£18.45
Amiga for Beginners	£15.45
Amiga Hardware Ref. Manual	£25.95
Amiga Machine Language	£18.45
Amiga Rom Kernel Ref. Auto Docs	£34.95
Amiga Rom Kernel Ref. Libs	£34.95
Amiga Rom Kernel Ref. Devices	£24.95
Amiga Dos Inside & Out Revised	£26.99
Making Music On The Amiga	£38.45
Mastering Amiga Printers	£19.95
Amiga Desk Top Video 2nd Edition	£20.95

WIN

- Hard Drive for your Amiga 600/1200 ●
 - Memory for your A500/600/1200 ●
- Details with every order & Cat Disk. And on request.

GAMES

+ 904 DRIP	(FAMOUS)
+ 908 STARTRECK	(2 DISKS)
+ 909 TANX	(ADDICTIVE)
+ 910 CHESS	
+ 915 MISSILE COMMAND	
+ 916 AMOEBA INVADERS	
+ 917 ROLLERPEDE, INVADERS	
+ 918 AMIGA DRAGON TILES V2.5	Great tiles game
+ 919 ZEUS	
+ 920 HOLLYWOOD TRIVIA	
+ 922 THE SIMPSONS	
+ 925 WIZZY'S QUEST	
+ 926 THINK TWICE	Master Mind
+ 927 HYPER-BALL	Arkanoid clone
+ 929 SEALANCE	Submarine Sim, Good
+ 930 SHAPES	Good for Kidz
+ 931 WACKO Jr.	In Wonderland
+ 934 SCRABBLE	
+ 935 WORMHOLE	
+ 936 ANAGRAMS	
+ 939 SKY FLYER	
+ 940 GALACTIC FOOD FIGHT	
+ 941 ATIC ATAC	
+ 942 D-TRIS (TETRIS)	
+ 943 ARCADE CLASSICS	inc space invaders
+ 944 NU THE SHOOT EM UP	Great stuff
+ 945 CARD GAME	S lots
+ 947 E-TYPE	The best Asteroids clone, NEW
+ 948 TETRIS	Best Tetris Clone out
+ 950 15 GAMES	by Assassins
+ 951 TOTAL WAR Like RISK	(Strategy)
+ 952 YUM YUM	
+ 953 BATTLEMENTS	Remember HUNCHBACK?
+ 955 INTERNATIONAL CRICKET	
+ 956 PIPELINE	Like Pipemania
+ 957 MATHS ADVENTURE	Excellent Maths Quiz
+ 1050 SURVIVOR	Dungeon Master Type Game
+ 1051 ESCAPE	Escape from the Dodgy Floor
+ 1052 BEAST	Corner the Beast
+ 1055 QUADRIX	Brilliant Puzzle Type, 10/10
+ 1056 CROSSWORD CREATOR	
+ 1057 QUESTIONTORT	Create Multi/Choice Quiz's
+ 1092 ESCAPE V.3+	Snowgame
+ 1100 GX200	New game
+ 1106 MENTAL IMAGE GAMES 1	c64 type great
+ 1107 MENTAL IMAGE GAMES 2	Sim above
+ 1150 HELLZONE	Close to R-Type
+ 1151 SERENE III	Another great shoot'em up
+ 1152 NUMPTY & THE ALIEN INVADERS	Manic Miner
+ 1153 FLAG CATCHER	Watch those bombs!
+ 1154 BATTLE OF BRITAIN & WAR	Like Risk!
+ 1155 ANTEP	New
+ 1156 TOP SECRET	New
+ 1157 MASHIE NIBLICK GOLF	Golf
+ 1170 ASSASSINS GAMES V30	Another great collection
+ 1171 WIZARD WORLD	Great fun and graphics
+ 1172 LEEDINGS	Similar to Lemmings
+ 1174 DONKEY KONG	Great conversion
+ 1175 FULL HOUSE	Play your cards right!
+ 1176 SPACE TRAX	Space game
+ 1177 TURBO THRUST	Good new Thrust game
+ 1186 RAID	Very similar to SWIV
+ 1187 X.F.1 & H-BALL	Like Tron
+ 1188 DOWNHILL CHALLENGE	Ski-ing
+ 1189 MEGABALL	Arkanoid Clone
+ 1190 PUGGLES	Remember Cuddly Cubert
+ 1193 OTHELLO	New
+ 1205 SANITY	Brilliant new game, slideshow & fab music

+ 678 SID V2.0	THE LATEST CLI IS A BLAST WITH THIS ONE
+ 797 TYPING TUTOR	MEASURES TYPING SPEED AND ADJUSTS LEVEL OF DIFFICULTY
+ 799 CLERK	FANTASTIC ACCOUNTS PROGRAM FOR BUSINESS OR HOME
+ 839 DESKTOP PUBLISHER	MAKE LEAFLETS etc WITH GRAPHICS + TEXT GOOD
+ 857 SUPERKILLERS	KILLS SADAM PLUS 171 MORE VIRUS'S LATEST
+ 840 TEXT PLUS V3.0C	WORD-PRO MENU DRIVEN AREXX SUPPORT THE BEST
+ 808 P.C. EMULATOR	RUN P.C. SOFTWARE IT WORKS COME WITH C.G.A. GFX NEEDS MS-DOS
+ 710 AMIBASE	POWERFUL EASY TO USE DATABASE WITH 4 MATHEMATICAL FUNCTIONS
+ 858 JR-COMM 1.02	THE LATEST VERSION OF THIS COMMS PROGRAM GOOD
+ 704 NORTH 'C'	UNPACK ONTO 2 DISKS COMPLETE 'C' ENVIRONMENT
+ 686 T.V. GRAPHICS	2 DISK BACKGROUND & FONTS FOR VIDEO ENTHUSIASTS ETC
+ 684 VIDEO APPLICATIONS	2 DISK VIDEO UTILITIES TO ACCOMPANY TV GRAPHS
+ 731 SMOVIE	AMAZING TITLE AND TEXT SCROLLER FOR VIDEO ETC
+ 688 DISK SALV	MUCH MUCH BETTER THAN DISKDOCTOR ON W.B
+ 681 BATTLEAXE ICON STUDIO	THE TOP ICON MAKERS AND EDITOR WITH SOME ICONS
+ 683 D.K.B. TRACE	EXCELLENT RAY TRACE PROGRAM
+ 650 QUICKBASE, LABELPRINT, VIDEO-LIBRARY, MENU	1 DISK GOOD VALUE
+ 703 GRAPHIC UTILITIES	TOTALLY PACKED WITH GRAPHIC STUFF
+ 781/2 DYNAMITE FONTS 1 & 2	2 DISKS FULL OF FONTS TO USE IN DPAINT ETC
+ 761 MEGA UTILS	50+ YES OVER 50 USEFUL UTILITIES
+ 725 ANTIFLICKER	STOPS SCREEN FLICKER IN INTERLACE MODE
+ 885 AUDIO MAGIC V1	FULL OF USEFUL MUSIC SEQUENCERS & SOUND RIPPERS
+ 886 AUDIO MAGIC V2	IF YOU HAVE THE ABOVE, YOU'RE BOUND TO WANT THIS
+ 888 DEVPAC SOURCE CODES	LOTS OF PROGRAMS FOR YOU TO EXPERIMENT WITH
+ 890 GELIGNITE FONTS	MORE GREAT LOOKING FONTS TO USE IN YOUR PAINT PACKAGE ETC
+ 892 MESSY SID II	AN UPDATE TO THIS GREAT FILE CONVERTER, AMIGA <> PC
+ 844 LITTLE BENCH 2.0	A GREAT WB REPLACEMENT, WITH LOTS OF USEFUL UTILITIES
+ 846 MAGNETIC PAGES	MAKE YOUR OWN MAGAZINE ON DISK, OR TUTORIAL etc
+ 1001 MED V3.2	THE VERY LATEST AND BEST MUSIC PROGRAM
+ 1002 ESSENTIAL UTILS III	A GREAT COLLECTION OF UTILITIES
+ 1003 ASSASSINS MEGABOOT	MASSIVE COLLECTION OF BOOT-MAKERS
+ 1004 MR BACKUP V5.02A	BACKS UP YOUR HARD DISK IN MINUTES
+ 1006 AMIGA PLUS UTILITIES	SPECIALLY FOR THE A500 PLUS
+ 1026 NCOMM 1.921	BEST COMMS PROG + HOST OF ARCHIVING FILES etc
+ 1027 DCOPY V2.0	GREAT D-MOB COPIER, FORMAT, NIBBLE COPY, DOS COPY+ & MORE
+ 1029 HYPER CAT V1.2	STORE 9999 DISKS/PROGS. BY NAME OR DISK NO.
+ 1038 PIC BASE	SPECIAL DATABASE FOR STORING IFF PICS, VIEW THEM etc. KEEP TRACK OF YOUR ART
+ 1042 ASTRO 22	Professional Astrology Great
+ 1053 HARDWARE PROJECTS A	GET THAT SOLDERING IRON OUT
+ 1054 HARDWARE PROJECTS B	MORE AMIGA PROJECTS
+ 1058 AMIGAZER	ANOTHER GREAT ASTROLOGY PROGRAM
+ 1059 PICTURE CONVERTERS PACK	CONVERT FROM C64, PC, ST, MAC AND MORE
+ 1060 MEGA MONITOR	DOES THE SAME JOB AS ACTION REPLAY NEARLY
+ 1122 REORG	GREAT DISK OPTIMISER
+ 1124 LE NAG	NEW LATEST EDITION EVENT MANAGER/CALENDAR
+ 1123 SCREEN BLANKERS	SAVE YOUR MONITOR
+ 1130 FREECOPY 1.8	LATEST UPDATE REMOVES PROTECTION FROM GAMES
+ 1162 AMIGA PUNT	A HORSE RACING PREDICTION PROGRAM
+ 1163 AGRAFH	PRODUCES GRAPHS, PIE CHARTS, BAR GRAPHS & MORE
+ 1164 LITTLE OFFICE	A WORD PROCESSOR, DATABASE & SPREADSHEET IN ONE
+ 1165 DIRECT ACTION	MERGE ANIMATION & SOUND, REQUIRES 1MB+
+ 1166 SLIDESHOW GENERATOR	CREATE YOUR OWN STUNNING SLIDESHOWS WITH MUSIC!
+ 1167 STRUCTURED CLIP-ART	SOME GREAT CLIP-ART FOR PPAGE ETC
+ 1178 TWIN EXPRESS (2 DISKS)	THE BEST PC>AMIGA, AMIGA>PC FILE TRANSFER PROGRAM
+ 1179 AMOS UPDATOR V1.34	UPDATE YOUR AMOS
+ 1180 AMOS COMPILOR UPDATOR V1.34	UPDATE YOUR AMOS COMPILER
+ 1191 V.C.R. FILER	KEEP TRACK OF YOUR VIDEOS!!
+ 1192 BLUE ROSE FONTS	SOME GREAT LOOKING FONTS FOR DPAINT

Catalogue Disk with FREE GFX Ripper £1.50

FOR ANY AMIGA

Compiled by us these disks are the best and latest editions. Our aim is to put a collection of progs of the same theme together. The disks self boot. No need to load workbench. They have easy to find, easily understood, easy to print instructions.

FX1 The Print Workshop	Utilities
FX2 The Hard Drive Workshop	Utilities
FX3 The Graphic Workshop	Utilities
FX4 The Video Titlers Workshop	Utilities
FX5 The Packers Workshop	Utilities
FX6 Disk Repair Workshop	Utilities
FX7 Hachers Workshop	Utilities

£1.50 each

AF1	DELUXE PAINT TUTORIAL. A great tut disk showing you how to produce great effects for logos, fonts etc, etc. Incredible info.
AF2	ULTIMATE VIRUS PROTECTION DISK.
AF3	POWER SAMPLES 1. Fantastic sound samples not seen on other disks.
AF4	POWER SAMPLES 2. More of the above & just as good.
AF5	MAXIMUSIC 1. Great music tracks.
AF6	MAXIMUSIC 2. More great music.
AF7	ANIMATION 1. Brill Ray Traced anim.

AM/FM

Amiga Musicians FreeWare Mag

The worlds best Amiga music disk magazine. AM/FM is just great. Full of tips, tutorials on well known software etc. Projects, some absolutely great music with each issue Amiga only and midi. If you are keen with music and your Amiga then you just don't want to miss this. Now on issue 9 and back issues available.

£2.50 per issue

LATEST

+1121/2/3/4/5	5 DISK C MANUAL NEW
+1126	CATACOMBE (GAME) GRAPHIC ADVENTURE
+1127	COLLOSAL (GAME) CAVE ADVENTURE
+1128	ADVENTURE GAME CONSTRUCTION KIT
+1129	C.V. RESUME MAKER GET THAT JOB
+893	AMIBASE PRO LATEST AND GOOD
+894	UEDIT TEXT EDIT
+895	AMICASH
+899	P.SUIT DISK CATALOGUER
+960	E-TYPE 2 COULD IT BE POSSIBLE
+1102	TEXT ENGINE 3.4 NEW
+1108	THE MAIN EVENT (EVENT/HANDLER GOOD I PAID)
+1078	ELECTRO CAD OBVIOUS
+1080	DATA EASY
+1096	TURBOQUILL 1.1 WORDPRO
+1070	TEXT ALOAD DOC VIEWER WITH SPEECH
+1099	ZERO G SAMPLES PURE SOUNDS
+1097	LITTLEBENCH 1.3 A LITTLE WORKBENCH
+1091	ARP V1.3
+1090	MEGA VIRUS KILLERS
+1089	OPTI UTILS 2
+1087	IFF CONVERT
+1086	SAS UTILS 1
+1084	CULPRITS UTILS
+1082	WORKBENCH HACKS
+1081	SUPER C
+1083	32 HELPFUL UTILS
+1093	EYE OF THE BEHOLDER HINTS MAPS & SOLUTIONS
+1103	BRAINSTORM MUSIC DISK GOOD SOUNDS
+1131	E-TYPE 2 GREAT GAME
+1136	CANON & HP PRINTER DRIVERS
+1137	STAR & CITIZEN PRINTER DRIVERS
+1138	PRINTER & PLOTTER DRIVERS HUGE SELECTION
+1139	ALL ROUNDER GREAT NEW GAME

DESKTOP VIDEO PACKAGE

This pack has been made due to the great demand for this type of material. It consists of: Smoveie the text scroller, 2 disks full of backgrounds & fonts, & 2 disks full of Video Application utility software.

£6.50

UGA AMIGA INTRO PACK

GREAT COLLECTION OF PROGS TO HELP YOU GET THE MOST OUT OF YOUR AMIGA - MAKES LIFE VERY EASY - TEXT EDS, COPIERS, DIR UTILS, CRUNCHERS - WELL REVIEWED IN AMIGA COMPUTING JUNE ISSUE

£5.00

BUSINESS PACK

WORDPROCESSOR, SPELL CHECKERS, DATABASE, SPREADSHEETS, ACCOUNTS & MORE Regularly updated with latest

£6.50

EDUCATION PACK

Contains following educational programs: SpellCheck, German, Spanish & French Tutor, Study Aid, Counting, Division, Mathematical, Reflex Test, The Weather, CalcKey, Gravity Well, AirFoil, Unit Converter, World DataBank, Plot, Quiz, Sherlock, Evo, Capitals, Maths Adventure, Elements, The Gallows & CryptoKing.

£6.50

GAMES PACK

Packed with great games from arcade to board games including: Amiga Tanx, Amoeba Invaders, Missile Command, Rollerpede, Copper, PacMan, Galaga, SYS, Towers, BackGammon, Amigoids, Space Rescue, YachtC, Drip, Chess, Naka, AirAce II, SubAttack and 15.

£6.50

DISKS 1-10 £1.50
10+ £1.25
TBAG, FISH £1.50

POSTAGE ALL ORDERS £1 SAME DAY DISPATCH UK £1.50 EUROPE £3 REST /WORLD

AMIGA 1200

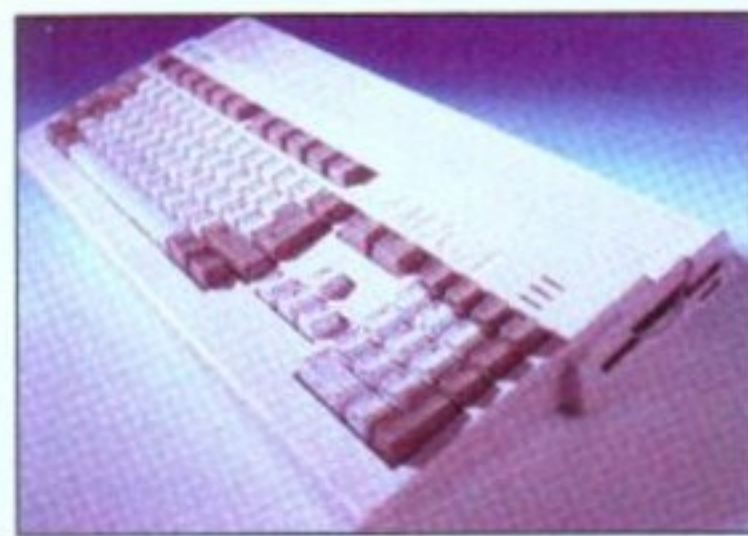

AMIGA 1200, 68020 Processor, 14:19MHZ 32-BIT, 2MB Chip RAM Standard. Amiga Dos v3.0, Optional Hard Drive (See below). AA Chip Set for enhanced graphic capabilities, 16.8 Million Colour Palette, 2-256,000 Colours on-screen, PCMCIA Smart Card Slot for memory exp. 96 Key keyboard with numeric Keypad and 1 year On-Site Warranty. Also with free package from BattleAxe containing a Word Processor, Database, SpreadSheet and 3 Games.....

Prices for AMIGA 1200 Inc Hard Drive

AMIGA 1200 with 85 MB Hard Drive

£ Call For Low Low Prices

AMIGA 1200 with 120 MB Hard Drive

£ Call For Low Low Prices

Hard Drive Models Come With Our Own 12-Months Warranty

AMIGA 1200

We can supply, or install a Fully Compatible 2.5" IDE Hard Drive. At a very competitive price. Complete Installation and Full Easy-Fitting Documentation included. Fully Guaranteed for 12 Months. We can arrange Collection of your Machine and 24hr turn around - Various Sizes including.

85MB



120MB

Prices Varying Constantly. Call for lowest available price

A1200 EXPANSION

Expansion for the Amiga 1200

- Fits in the Trap Door.
- 68881 Motorola Floating Point
- Maths Co-processor, Speeds up Floating Point operations up to 55 times. (Ray-Tracing etc.)
- 0/2/4/8 Meg populated (Sims)

0MB POPULATED£ P.O.A.
2MB POPULATED£ P.O.A.
4MB POPULATED£ P.O.A.
8MB POPULATED£ P.O.A.

MODEMS/COMMS

THE SUPRA-FAX MODEM

v.32bis (14400 baud !!!)
Allows you to send and receive fax messages. This new modem from Supra has full 14400 baud capability. Spec includes V.32bis, V.32, V.22bis, V.22, V.21, MNP 2-5, V42, V42bis, CLASS 1 & 2 commands. 9600/14400 Group 3 Fax, Includes free comms software and Modem Cable.

THE POCKET-FAX MODEM

Allows you to send and receive fax messages. This modem comes with carrying pouch and is easily connected to your or a friends modem. Comes with Battery. Includes free comms software and Modem Cable.

£ Call For Low Low Prices

E&OE
Prices subject to change without notice

PERIPHERALS

Triax Turbo Touch 360

Fantastic New Console Type Control For The Amiga

A radically new style of hand-held controller from Hornby. Feather-Touch direction pads and 3 buttons. We believe this will improve game-play and provide superior control.



£ 39.95

GREAT VALUE HAND SCANNER

400 DPI HAND SCANNER FOR ALL AMIGA'S

£ 94.99

- 400 DPI RESOLUTION
- REAL-TIME DISPLAY, SCAN IN & SAVE/LOAD
- PASS-THRU PRINTER PORT DESIGNED
- SCANNER ACTIVATION INDICATED BY L.E.D.
- FULL SOFTWARE & WELL-MADE INTERFACE

G.V.P. Digital Sound Studio

High quality 8-Bit Stereo Sampler, Sample up to 51,000 samples/second in stereo. Special effects inc. echo, mix, filter, re-sample & much more. Works with any Amiga inc. 1200 4-Track sequencing Software with Midi Support. Create SoundTracker Compatible & Stand Alone Song Files with the great DSS Software v1.6



SOFTWARE

GOLD DISK OFFICE 11

5 FULLY INTEGRATED PROGRAMS THAT MAKE AN EASY TO USE HIGHLY PRODUCTIVE OFFICE W.B.2. COMPATIBLE (WRITE) WORD PROCESSING (FILE) DATABASE MANAGEMENT (GRAPH) BUSINESS GRAPHICS (CALC) SPREADSHEET CALCULATIONS (PAGE) DESK TOP PUBLISHING.

£129.95 ~~£54.50~~
£179

IMAGE FX

!! Supports AA Chip Set (1200/4000) !!

High Powered 24-BIT Image Manipulation SoftWare. A wealth of features include image colour correction, analysis, transformation and photographic adjustments. Scanning Support etc and includes the fantastic CINEMORPH Morphing Package. Requires 3MB RAM, ARReXX Support, anim Generator, Printing and more. RECEIVED TOP MARKS IN REVIEWS.

ACCESSORIES

100 CAPACITY DISK BOX£7.99
MOUSE MATS£3.49
MODEM & NULL MODEM CABLES£9.99
AMIGA TO SCART CABLES£9.99
DISK DRIVE H/CLEAN KIT£3.49
PRINTER CABLES 2M£6.99

ACCELERATE YOUR A500

With our range of Accelerators, Very Fast at a reasonable price. Phone for Prices & Details

MIDI INTERFACE

FOR THE AMIGA 500, 500 PLUS, 600 AND 1200
Connect your Amiga to the World Of Musical Instruments.
!!! INCLUDES LEADS !!!

- Amiga Pass Thru serial port designed.
- Supports 1 Midi In, 2 Midi Out and 2 Midi Thru
- Midi Serial Activation indicated by L.E.D.
- Standard Midi With Full Opto-Isolated

£ 24.99

CREDIT CARD
HOTLINE
9am _____ 9pm
(0603) 261 060



When ordering by post, please make cheques payable to BattleAxe and include Name, Address, Post Code and if possible a day-time Tel No. along with your order requirements. Thankyou.

AddHard

Ashcom Computers ■ 0530 411485 ■ £279

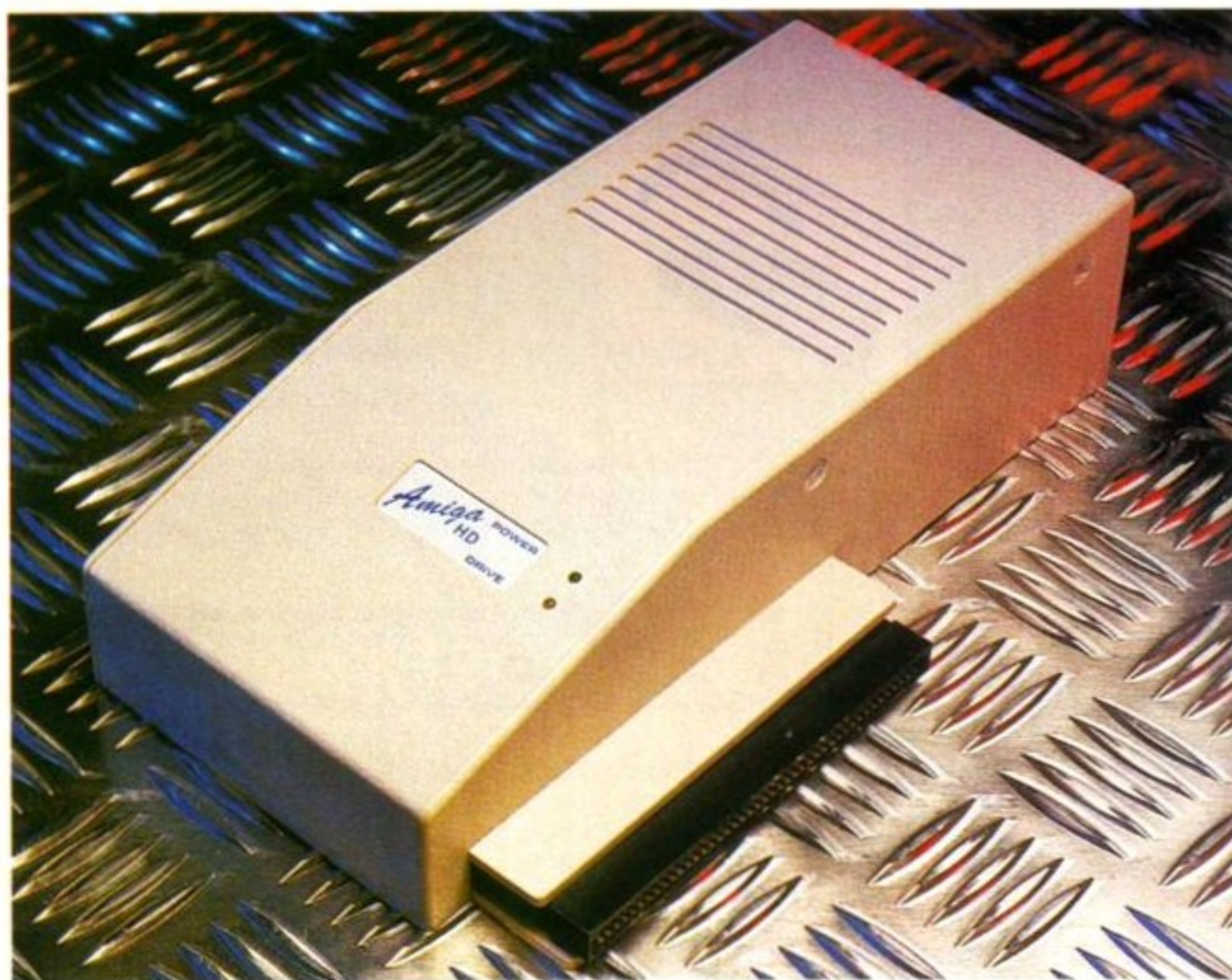

This photograph of the unit can in no way convey the plastic tackiness of the Addhard. If it was a budget buy, fair enough – but the price is anything but cheap.

AMIGA FORMAT

50

MARCH 1993

IF LOOKS COULD kill, the AddHard would be a mass murderer. From its tacky soluble plastic case, to the lack of a SCSI expansion port or a capability to take an extra power supply, the drive looks like an exercise in extreme cost cutting. Forget the misquote in the advert: "Best buy – high quality – low price", because I was talking about Ashcom's 512K RAM expansion, not this piece of tat.

Maybe I'm being a bit harsh. Under the cover, it's the bare bones of a system – a SCSI controller chip, a ROM chip and a few more chips to talk to the A500 or A500 Plus. This lack of sexy technology means that the drive boots up and runs like lightning – its one and only selling point.

But don't think you're getting a good deal. For a start, you get no manual – just a single side of A4, detailing the steps to get the drive up and running. Oh yes, and three colour flyers advertising other Ashcom products.

One of these products is the AddAx external RAM expansion. This can be fitted in-between the AddHard and the Amiga. Which is just as well because the AddHard has no facility for taking memory on its own. If you cost it up, an AddHard/AddAx with 2Mb of RAM costs £400 – which is more than a 2Mb GVP drive! And of course, the Ashcom system is about six inches wide – which is quite an addition to your desk space.

Assuming you want to reformat the hard drive, you've got a problem. The supplied Setup software, while looking very pretty, seems to do absolutely nothing except crash. It's bugged to hell. It doesn't tell you what make and model of hard drive is fitted. Presumably it can find this information out through the SCSI.

However, it's not all bad. You do get a disk packed with shareware disk utilities. Two

back-up programs, the Sectorama track and sector editor, and a few disk fixers and performance testers. Shame that the package doesn't contain any printed instructions on them.

I guess this indicates the market that the AddHard's aimed at. If you have had an A500 for a few years, and have an oversize trapdoor RAM expansion (bigger than 512K) then the AddHard would be a very good choice of hard drive. Such a buyer would have a greater understanding of the supplied utilities, and let's face it, you probably won't need any external SCSI equipment.

I simply cannot understand why Ashcom are charging so much for this unit. They're literally cutting their own throats – the only sort of person who would actually want one can't afford it. With decent setup software, a decent manual, a game switch and a bit more in the way of user friendliness and £75 off the price, it would be a really good buy.

As things stand, you'd have to be either a total speed freak with no thought for the future, or one of those weirdos who needs every single peripheral to be of the same make, to buy this unit. Sorry Ashcom – there's just no way I'd recommend to anyone that they buy this hard drive. It's the worst I've ever seen for the Amiga.

Setorama, one of the bundled shareware utilities, is the only low level binary track editor that I've seen for the Amiga. Most people would never need or understand it.

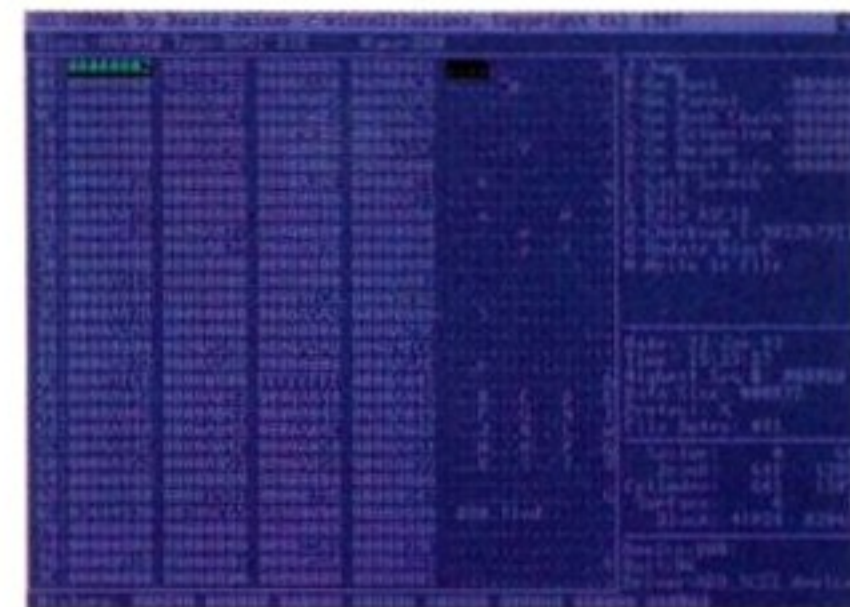

The setup software for this unit appears to have all the necessary functions. Click on the wrong icon at the wrong time and you get a flashing red Software Failure message.

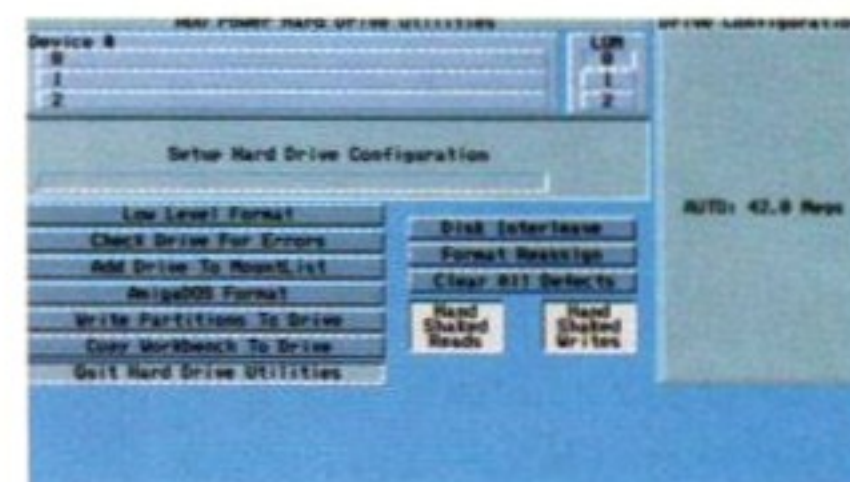

A600/A1200 OWNERS!

You must be feeling cheated off. No SCSI interface, no removable media, no tape streamers. Well, don't worry about it. Because one great benefit of the IDE (Intelligent/Integrated Drive Electronics) hard drives is that they're cheap. And they can be fitted internally without an interface – which makes them cheaper again!

So why don't they seem cheap now? The main reason is that there is a great shortage of them in the UK at present – if you were to travel to the Far East, you can pick them up for peanuts. This scarcity is pushing the price of the units up. Plus there is the autoboot problem, which means that companies have to test the drives to make sure they are compatible.

All right, so you can't build up a hard drive chain like you can with SCSI – if you want 40 Mb of storage,

you have to fit one drive of that capacity. But in terms of everyday convenience, IDE is a better system for the average user.

The IDE standard does provide for one extra hard drive plugged into the first. However, I have never seen this done on any Amiga with an IDE drive. I guess it's possible, but people don't bother for some reason.

PCMCIA hard disks are still not around. These devices are similar to A500/A500 Plus external hard drives, but they are much, much smaller.

Don't think that SCSI will never be available on the A600 and A1200. You can get PCMCIA card interfaces for SCSI already – the problem is that nobody has yet written a set of Amiga driver tools for the things. When that happens, you'll have the best of both worlds, if you really do need a big SCSI chain.

AddHard

SPEED

It is very, very fast. Fragmentation problems can reduce this, as with all hard drives.

DOCUMENTATION

What documentation? One side of A4? Surely they must be joking?

ACCESSIBILITY

Lousy setup software which just seems to crash, and there's no game switch.

FEATURES

No SCSI port, through port doesn't work and the case would probably melt easily.

VALUE

Well over the odds – a 2Mb GVP is cheaper than a 2Mb AddHard!



30%

External CDTV

ZCL/Calculus ■ 0543 414817 ■ £299.95

ZCL'S PREVIOUS EFFORT at putting a hard drive into a CDTV met with some harsh comments in our Super Amigas feature (AF38 - 75 per cent). Does this external deal make a better package, or is it more of the same warehouse-clearance tactics to shift old stock?

Before I get to that, the company have recently made a decision to market the SCSI interface for CDTV separately. For the princely sum of £99.95, you get the interface, Workbench 1.3 and Extras 1.3, the hard drive manual, an A500 manual (useful for learning AmigaDOS commands, but with lots of irrelevant information too) and erm, that's it. Compared to the price of SCSI controllers for the A2000 and larger Amigas, this is actually quite a good deal. So if you know where you can get SCSI hard drives cheap, that's a much better option.

Still, the deal being reviewed here is not bad at all. As well as the above, you get a nice designer, matt black SCSI hard drive unit, the power lead (with a plug) and matching black SCSI connecting lead. The hard drive has two SCSI connectors (the proper 50-pin Centronics types), so adding more SCSI units to the system is no problem. Just plug them into the back of the existing hard drive.

As with most hard drives, it's preconfigured with Workbench already on it (ZCL are, after all, Commodore's official distributors). In case it ever goes down, there's the standard CBM *HDTtoolbox*, suitably tweaked to make the best use of the CDTV SCSI. If you've never used this program before, it can be a somewhat traumatic experience - but with experience comes competence.

Eventually, you wonder what all the fuss is about. *HDTtoolbox* has always been able to

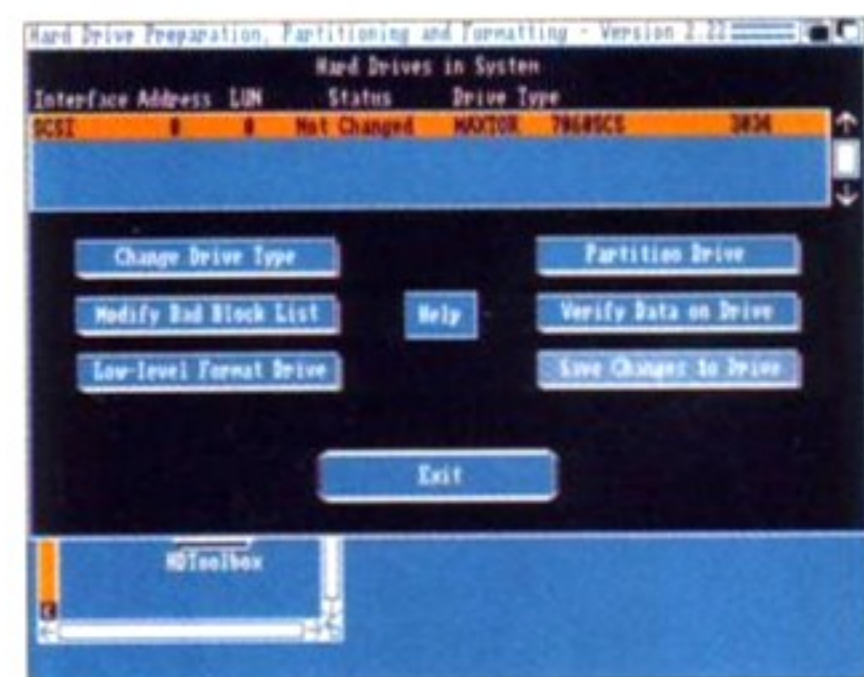

The official CBM *HDTtoolbox* still looks as ugly as ever - but it's got all the vital features and it doesn't crash out on you when you least expect it. It's been refined over the years, and this version is fine for 99 per cent of hard drive tasks.

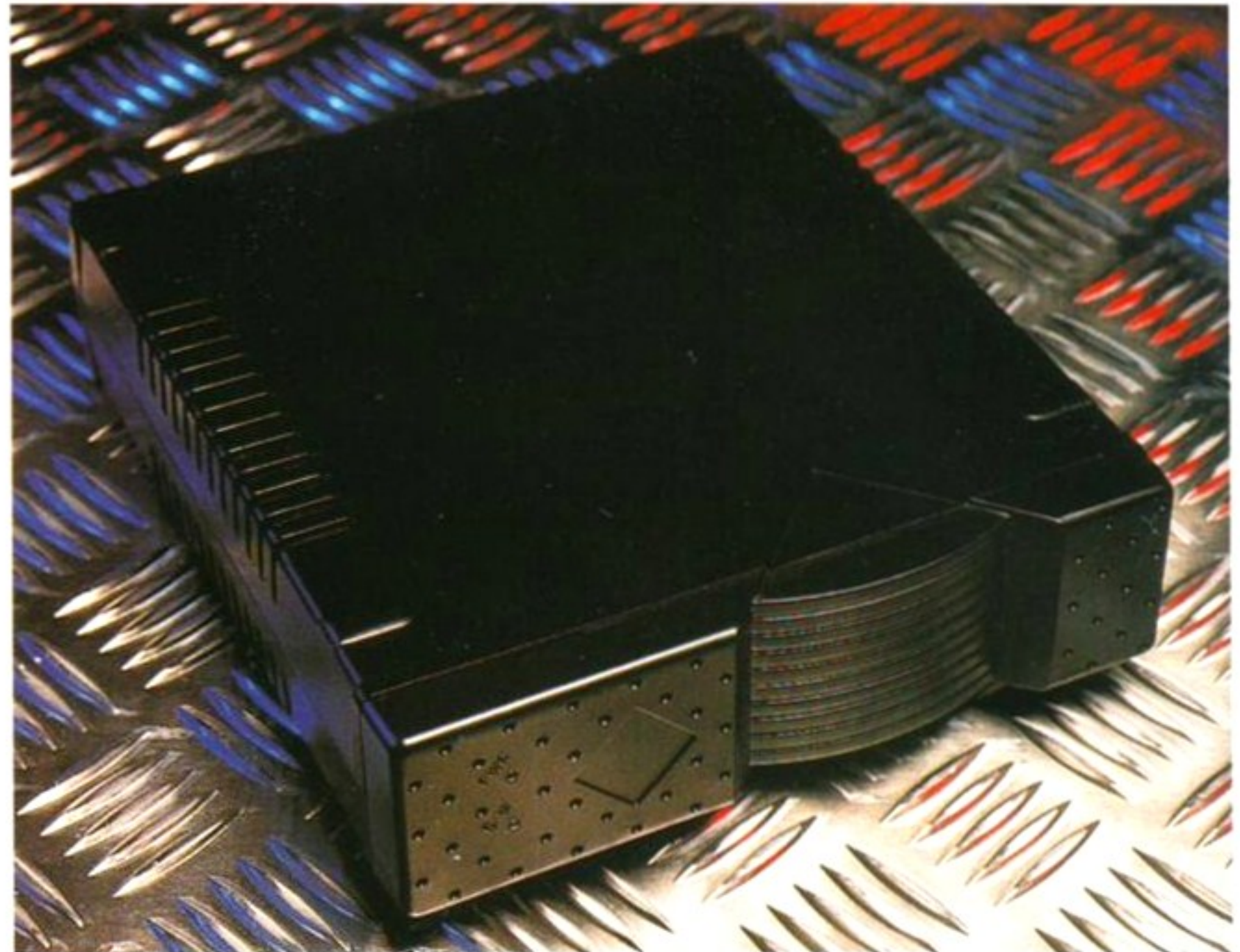

low-level format, and so should work happily with every single SCSI drive in existence.

Is it any good? Well, a 65 Mb of hard drive is not bad at all, especially if you want to play games like *Eye of the Beholder* or *Monkey Island 2*. But, as with all hard drives, some memory is consumed. The good news is, as all CDTVs have 1Mb of chip RAM, games are more likely not to run, because of a lack of chip RAM, on an old A500 with a hard drive than on this beast.

The difference between this external hard drive and the internal one is convenience. This one is easier to disconnect if you have memory problems - just undo the two screws securing the SCSI interface (the manual recommends you just leave them out) and pull the card back about an inch. With the internal version, you cannot undo the interface without disconnecting the internal ribbon cable - which means undoing about 30 screws!

The manual is actually pretty good, if a bit thin. Dave Cheetham of ZCL has assured us

that it's only a first draft, and there's a lot more to go in - the only omission is it doesn't tell you how to copy your Workbench disk to the hard drive. As Workbench is already there when you buy it, and the manual will be added to extensively, so I don't see it as a problem.

This hard drive is seriously good news for CDTV owners - what's even better news is that it mentions that fast-RAM cards should soon be available for CDTV. Good heavens, can this be true? Can you run really big applications on the black magic box?

To be perfectly honest, I just don't know. As I write this, at a quarter to midnight, I'm trying to ring Jim Mackonochie (Mr CDTV) at an Amiga Developers Conference in Florida to confirm or deny it. The phone is ringing... ringing... ringing... I guess we're going to have to wait till next month. Sorry.

MAINTAIN YOUR INVESTMENT!

When you first get your hard drive, it's a very good idea to set it up two or three times, to get a feel for how things work. It's also a good idea to split it into two or more partitions. These show up as different disk icons on Workbench, but are really different areas of the same hard disk. Each partition takes some memory away from your Amiga, but it's still a good idea.

The reason for this is that, with a hard drive, you are literally putting all your eggs in one basket. A computer virus can easily copy itself to the hard drive and destroy the contents within minutes. Also, a sloppy installation program can put a read/write error on a partition, which means that nothing else can be copied to the partition until it's been formatted again or the bad file has been deleted.

If your work is financially valuable, then some

method of backing up the hard drive is a sound investment. SCSI tape streamers are one method - simply drag a partition to the tape streamer icon, which is safe to be referred to if you have a problem later. Power Computing's Video Tape Backup system is still being evaluated, but looks promising and is much cheaper than a tape streamer.

Everybody else, get a copy of *Quarterback* and *Quarterback Tools*. These are both very easy to use - the first enables you to make back-ups of your hard disk to lots of floppies, compressing as it goes. *Quarterback Tools* is good for wiping bad files and defragmenting your hard disk - in a nutshell, making it work as fast as when it was new, without formatting and recopying everything by hand. If you don't do this, eventually your hard disk runs as fast as a tortoise.

External CDTV

SPEED

● ● ● ● ●
Pretty good, considering no fast RAM was available on the test CDTV.

DOCUMENTATION

● ● ● ● ●
Should be OK - the early drafts look very promising indeed.

ACCESSIBILITY

● ● ● ● ●
It's there when you want it, and you can unplug it when you don't.

FEATURES

● ● ● ● ●
Shame there's no fast RAM capability, but that might happen yet on CDTV.

VALUE

● ● ● ● ●
Not bad at all for an external 65Mb SCSI unit. Even better for a cute black CDTV drive.



83%

New Horizon Computers

The Hard Drive Specialists

A600 & A1200 Hard Drives

The ESSENTIAL add on for all
SERIOUS Amiga users.

Upgrade your A600 or A1200 with a brand new internal IDE Hard Drive. All our Special Installation Kits come complete with fully formatted IDE Hard Drive, cable, mounting kit and fitting instructions.

All New Horizon Hard Drives are sourced from Brand Name suppliers and have been fully tested for 100% compatibility with the Amiga A600 and A1200.

FULLY INCLUSIVE PRICES

SIZE	DRIVE	WITH 600	WITH 1200
20 MEG	£120.00	£385.00	£495.00
40 MEG	£180.00	£ NA	£555.00
64 MEG	£200.00	£455.00	£575.00
84 MEG	£250.00	£485.00	£605.00
127 MEG	£365.00	£625.00	£745.00

ALL OUR DRIVES COME PARTITIONED, FORMATTED
AND WITH WORKBENCH 2 OR 3 INSTALLED
A600's & A1200's & PCMCIA CARDS
NOW IN STOCK - PHONE FOR LATEST PRICES

SPECIAL OFFER

For A600 & A1200 Owners

New Horizon will collect your machine, fit the drive of your choice and return your machine by overnight carrier to any mainland UK address for a fully inclusive price of only £38.50. Offer lasts till March 20th 1993 only. Phone our Sales Hotline for further details.

A600HD Owners - Upgrade to a bigger drive. Phone for more details.

Installing a Hard Drive will invalidate your Commodore Warranty so all Computers fitted with a New Horizon Drive are covered by our own Full 12 Month RTB Warranty from date of purchase.

HOW TO ORDER

1. By Phone 

FREE next working day delivery on all items shown and for Credit Card orders placed before 3pm (UK Mainland only). Saturday delivery add £10.00.

2. By Post 

Send a cheque or bankers draft made payable to "New Horizon Computers" and post with your order to :

New Horizon Computers,
Mail Order Dept
High Hope, Lea,
Ross on Wye,
Herefordshire HR9 7LN.

Remember, when you buy
from New Horizon
Computers you receive :

- ★ Fully Inclusive Prices
- ★ No Hidden Extra's
- ★ Free Next Day Delivery
- ★ Full Technical Support
- ★ Full After Sales Service



CREDIT CARDS
WELCOME

VISA

New Horizon Computers, High Hope, Lea,
Ross on Wye, Herefordshire, HR9 7LN
Tel : 0989 750260 Fax : 0989 750337

SALES HOTLINE 0989 750260 TECHNICAL HELP 0989 750337

DIAMOND



Buy With Confidence

Reasons To Be Cheerful, Part 10

1. **Diamond** shops are strategically based within major cities and not on expensive industrial parks. The majority of our shops are owned by Diamond so overheads can be kept to a minimum, hence guaranteeing you the best prices.
2. **Diamond** have over 100 staff, with over 50 trained sales people and dedicated engineers in every shop.
3. **Diamond** having retail shops allows you to see and evaluate any merchandise before you make your purchase.
4. **Diamond** are always easy to contact, we have 50 telephone sales lines, 16 fax machines & a separate Direct Mail Order Service number.
5. **Diamond** have a full Customer Service Dept. at head office in Southampton which has been quoted in the press as "the envy of the computer retail market."
6. **Diamond** are Northern Europe's leading Amiga dealer.
7. **Diamond** have in excess of 3000 product lines in every store at any one time.
8. **Diamond** offer technical support six days a week & are regarded as Amiga experts.
9. **Diamond** Prices are unbeatable and that is guaranteed with our Price Pledge which promises to match any other dealers price.
10. **Diamond** philosophy works, in a recent independent survey it was shown that 9 out of 10 customers preferred to buy from a local source. Diamond promise that during 1993 we will continue to expand to bring us even closer to you.

**NEW SHOP OPENING
IN PORTSMOUTH**
Phone 0703 232777
for details

Listed below are just some of the people who trust Diamond's Philosophy

BBC TV, MOD, British Telecom, GEC, British Aerospace, Rolls Royce, Shell (UK), HM Prisons, National Health Service RACAL, Granada TV, The Open University, Philips, Plessey, British Steel, Barclays Bank, The Royal Air Force & Royal Navy, Vosper Thornycroft UK, Mobil North Sea Oil, The Scottish Office, Scottish Nuclear Fuel, British Coal, British Rail, Thorn EMI, HM Customs & Excise, News International (The Sun, The Times etc.) and not to mention 27 local county councils & many many more.

THE DIAMOND PRICE - PLEDGE

If, whilst buying goods from us, you can show us a better price for the same goods in stock with one of our UK competitors then we will match it.

This pledge applies only to customers relying on this advertisement before the 10th day of the month of publication. It does not apply to competitors prices offered in closing down or stock clearance sales.

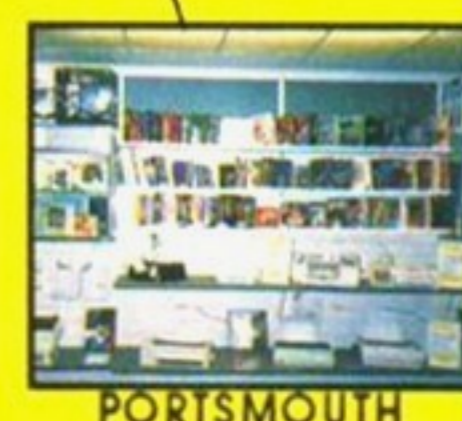
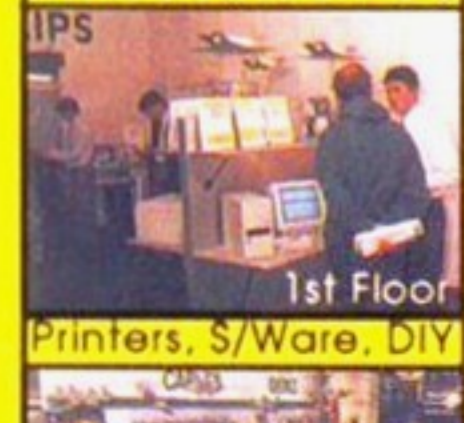
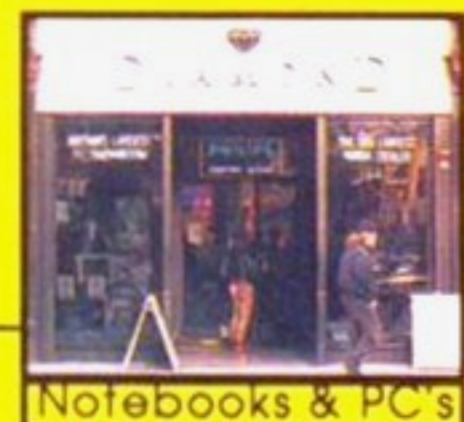
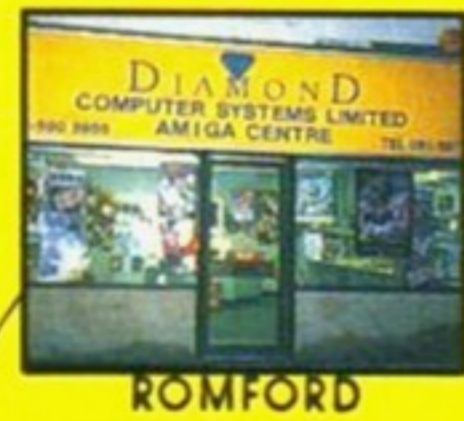
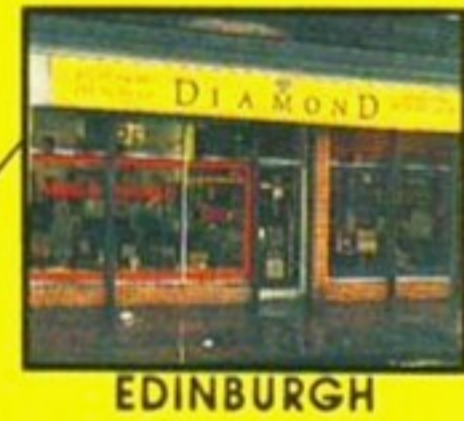
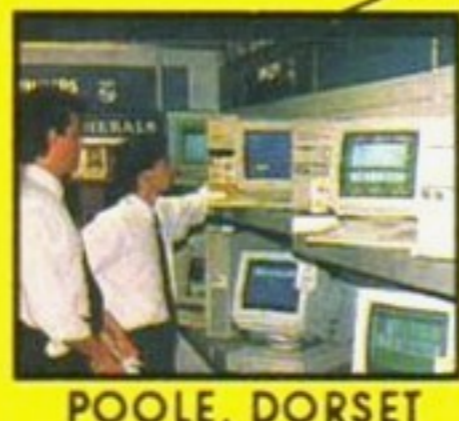

Very
Limited Offer
Re-badged Philips
8833 Monitor £149.95
 While stocks last only (200)
 TCR, London branch only.



FREE
Cpt. DIAMOND
SOFTWARE CLUB
MEMBERSHIP WITH
EVERY PURCHASE OVER \$100
 Limited offer until March 10th

Amiga 600

1Mb RAM **PACK** **1Mb RAM**
Basic A600 only £249.95

Captain Diamond's upgraded A600 packs using superb 2.5" Drives as used in most notebooks

40Mb only **£364.95** inc vat
 60Mb only **£419.95** inc vat
 80Mb only **£469.95** inc vat
 130Mb only **£619.95** inc vat
 170Mb only **£729.95** inc vat
 200Mb only **£819.95** inc vat

Or with 8833 Mk II Monitor +Turbo Challenge II Promotion + lead
ADD £209 inc vat
 12 month on site warranty
Add £44.95 for 1Mb extra RAM

A 600 a Hard Disk see opposite
 Hard Disk repairs: 12 months return to base

CAPTAIN DIAMOND'S AMAZING HARD DISKS

40Mb HARD DISK FOR THE A600 & A1200
ONLY £94.95

ADD £4.95 FOR AMIGA 1200 CABLE
 ADD \$9.95 FOR AMIGA 600 CABLE

60Mb only **£149.95** inc vat
 80Mb only **£199.95** inc vat
 130Mb only **£349.95** inc vat
 170Mb only **£459.95** inc vat
 200Mb only **£549.95** inc vat

For fitting by a Diamond engineer please add a further £49.95 to the purchase price. If you wish to fit your own Hard Disk please be warned, opening up your own Amiga may invalidate your guarantee.

All Hard Disks are 12 Months return to base warranty

Lotus 2 is not compatible with the Amiga 1200

2Mb RAM **PACK** **2Mb RAM**
AMIGA 1200 only £358.95
 (Limited Stock 200 only, then **£389.95**)

AMIGA 1200 ZOOL PACK
 featuring
Zool, Pinball Dreams
Transwrite & Striker
only £378.95 inc vat
 (Limited Stock 200 only, then **£408.95**)

12 MONTHS ON SITE WARRANTY

Or with 8833 Mk II Monitor +Turbo Challenge II Promotion +lead
Add £209.00 inc vat

We cannot be beaten on price

A1200 Memory Upgrade & Accelerator MBX Board
 (0k Ram Expandable to 8Mb)

68881 14MHz
 0kMb = **£139.95**
 1Mb = **£207.13**
 2Mb = **£266.89**
 4Mb = **£356.19**
 8Mb = **£559.90**

68882 25MHz
 0kMb = **£199.95**
 1Mb = **£267.13**
 2Mb = **£326.89**
 4Mb = **£416.19**
 8Mb = **£619.90**

Includes Maths Co-Processor
 Hard Disks are 12 Months return to base warranty

2Mb RAM **PACK** **2Mb RAM**
NEW AMIGA 1200
Ultimate Hard Disk pack

with 40Mb HARD DISK = **£484.95**
 with 60Mb HARD DISK = **£539.95**
 With 80Mb HARD DISK = **£589.95**
 With 130Mb HARD DISK = **£739.95**
 With 170Mb HARD DISK = **£849.95**
 With 200Mb HARD DISK = **£939.95**
 (These prices are for the 1st 200 customers only, then add £30 to price)

12 Months return to base warranty

With 8833 Mk II Monitor **add £209**
 We recommend you invest in a 80Mb Hard Disk instead of a 20Mb. Many games are growing in memory size, Workbench = 2Mb
 Monkey Island II Game = 8Mb
 That equals 1/2 your hard disk gone
 Who says size doesn't matter?

Amiga 1200

A3000

Workbench 2 - 25MHz - 2Mb Fast RAM
 2Mb Chip RAM - 3.5" Floppy
 105Mb Hard Drive
 only an incredible
£1528.00
£1298 (52Mb Version)
A3000 Memory Price = £149.95 per 4Mb RAM

A4000

Latest 25MHz 68040 CPU - 32Bit Architecture
 Built in Maths Co-Processor - 2Mb Chip RAM
 4Mb Fast RAM - Amiga DOS Version 3
 New AGA Graphics Chip Set. 120Mb H/Disk

£2088.00

A4000 32bit Memory = £159.95
 120Mb HD 2 + 8Mb = **£2238**
 240Mb HD 2 + 8Mb = **£2398**

The **NEW** Adventures Of **CAPTAIN DIAMOND**

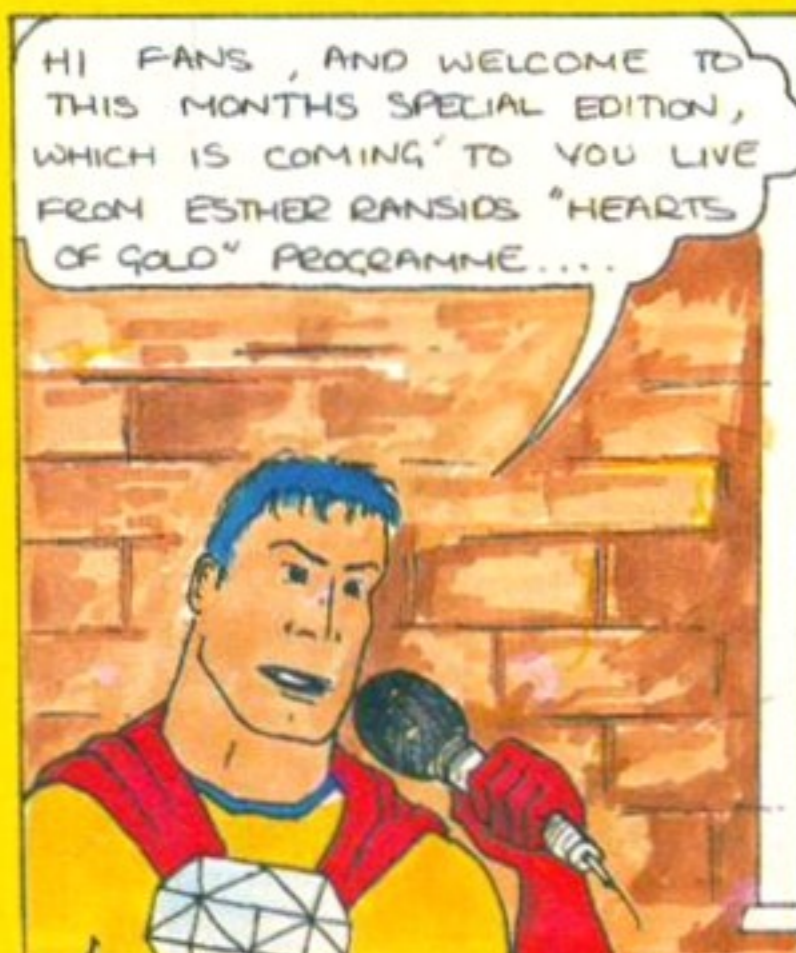

For your local Diamond branch details please see last page of this advert

NEW
Rochard 80Mb
Drive for Amiga 500
expandable to 8Mb RAM
now only an incredible
£299 inc VAT



Philips 8833 MkII Monitor with Turbo
Challenge II £199.95

+ Free F19 Stealth Fighter for the first 500 customers
Add £9.95 for connecting lead.

Roclite Drive with Anti click/Virus £59.95

CAPTAIN'S CHIP SHOP

4X256KDRAMS	
For A590'S etc	£3.50
1X1MB DRAMS For 8up/Supra	£3.50
1x9MbSIMMS (NEXUS/GVP/Rochard)	£34.99
4x9Mb SIMMS For GVP etc	£159.95
DISK DRIVES	
AMIGA Internal	£59.95
CDTV drive	£74.95
Roclite Slimline	
no click & Virus protection	£59.95
Diamond Amiga Drive	£49.95
New floptical Drive	£549.90
21Mb disk	£57.80

COMPONENT SHOP

SYQUEST DRIVE	
Removeable cart. 44Mb 28ms	£299.00
CONTROLLER for above add	£69.95
ROM SWITCHER	
Now Available	
1.3 - 2.04 ROM Switcher	£9.95
1.3 ROM available @	£29.95
2.04 ROM available @	£39.95

GENERAL ACCESSORIES

INTERNAL DRIVE KIT	
Replacement A500 Internal 3.5" drive kit, fully compatible with 1Mb unformatted capacity. Comes with easy to follow guide	£59.95
MICE	
New Roboshift, Auto sensing	
Joystick/Mouse switch box	£13.95
Primax Mouse	£16.95
Techno Mouse	
(With free Thunderhawk or Mystery Game)	£19.99
Naksha Upgrade Mouse	£22.95
TRACKBALL	
One hand control unit, after using this you will never want a mouse again	£29.95
LEADS & ADAPTORS	
Null Modem Cable	
Amiga to Amiga Lead	£16.99
Four Player Adaptor	£6.95
Amiga to Sony TV Lead	£14.95
CONTROL CENTRE	
Turn your Amiga into the ultimate hi-tech intergrated workstation environment.	
600 = £24.99 1200 = £39.99	
POWER SUPPLY	
Commodore A500 A600 PSU with the switch mode (£10 OFF with P/X)	£49.95
SOUND EXTRAS	
Amiga Sound Enhancer	£35.99
Stereo Speakers	£39.95
EMULATORS	
Golden Gate 386-20 for 1500/2000	£349.00
Golden Gate 486SX25.1500 /2/3/4000	£749.00
GVP 16MHz PC-286 1500/2000	£137.99
DUST COVERS A600/500/1200	£2.95 each

MEMORY UPGRADES

New Smart Card memory upgrade (A600)	
2Mb only £129 4Mb only £169	
New 2.04 Official Upgrade	
with manuals & ROM only	£79.95
A500 Plus 1Mb Expansion	£39.95
New A600 1Mb Expansion	£54.95
Supra 500RX 2Mb Expan.(500/500+)	£139.95
512K RAM Expansion + Clock (500)	£34.95
Above without clock	£29.95
1.5Mb Mb Expansion (Not Plus)	£79.95
1Mb Expansion with Thru-Port (500)	£49.95
8Mb RAM Board for A1500 or 2000	
Aries Board 0Mb	£79.95
For each 2Mb RAM add	£56.00
A500 ROM SWITCHER	
Switching between versions of Kickstart on your A500 could not be easier with our new ROM switcher.	£9.95
Kickstart 1.3 ROM (Supplied seperately)	£29.95
Kickstart 2.4 ROM (Supplied seperately)	£39.95

MONITORS

Philips 8833MkII +Turbo Challenge II
SALE PRICE ONLY
£199.95

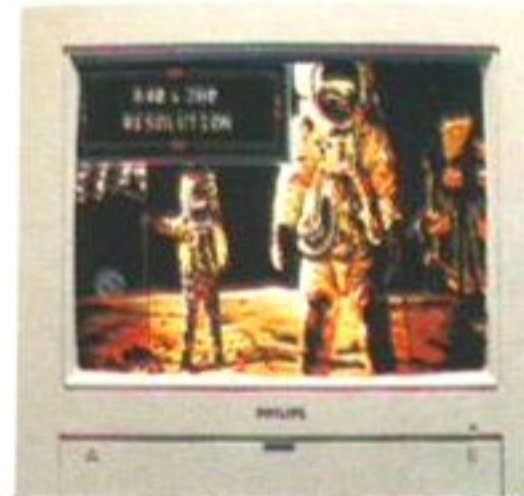

Add £9.95 for your connecting lead.

Philips 14"SVGA monitor, for A3000	
or A4000 with stereo speakers	£292.58
CBM 1960 Multisync Monitor	£429.95

GVP HARD DRIVES / ACCELERATORS

AMIGA 1500 / 2000 HARD DRIVE	
Impact Series II HC8+ Control Card only	£123.99
GVP HC8 + 42Mb Quantum for 2000	£282.95
GVP HC8 + 80Mb Quantum for 2000	£329.95
Impact Series II HC8+ & 240Mb Hard drive	£638.99
Impact Series II HC8+ & 420Mb Hard drive	£1038.99
GVP Impact Vision 24 Bit Card	£1499.00
AMIGA 1500 / 2000 ACCELERATOR CARDS	
G-Force 030-25MHz with 1Mb 32-Bit RAM	£469.99
G-Force 030-40MHz with 4Mb 32-Bit RAM	£755.99
G-Force 030-50MHz with 4Mb 32-Bit RAM	£1038.99
G-Force 040-28MHz with 2Mb 32-Bit RAM	£1415.99
FLOPTICAL DRIVE £549.90 (21Mb disk £57.80)	
AMIGA A500 HARD DRIVES	
GVP HD8 + 42Mb Quantum	£299.95
GVP HD8 + 80Mb Quantum	£377.00
GVP COMBO ACCELERATOR FOR A500	
GVP A530 + 80Mb Quantum	£755.95
A530 Combo 40Mhz + 120Mb H/D	£849.95
A530 Combo 40Mhz + 200Mb H/D	£918.00
68882 Co-Processor kit for A530	£208.99
GVP MEMORY RAM MODULES	
Series II RAM 8 RAM Card for Amiga 1500/2000 with 2Mb	£148.99
32 bit 60ns 1Mb SIMM for Accelerator Cards (A530 + G FORCE)	£63.99
32 bit 60ns 4Mb SIMM (A530 + G FORCE)	£178.99

DIAMOND MODEMS

Ever thought about the world your missing out on with your Amiga. Now with a Fax-modem you can link straight into bulletin boards for the latest info. or use your Amiga as a fax to send/receive hard copy.	
Diamond Dynalink Pocket Modem	
This Amiga Modem has a 9600 baud in send receive mode (Can be a fax using GP S/W)	£149.95
External (Via serial port) 9600Bps send/receive Fax + 14400Bps data modem; CCITT V.21, V.22 V.22Bis, V.32 with V.42.V.42Bis MNP 2-5	£249.95
SUPRA MODEMS	
Supra-Fax modem V.32 (14400 baud)	£258
Heavy Duty Prima Power Supply for above £10 when ordering the above Fax-Modem.	
Supra-Fax Plus (9600 baud)	£138.99
Supra 2400	£78.99
Turn your Amiga into a Fax Machine with GP Fax Software only £49.95 when buying any of the above Modems. £69.95 seperately.	

GRAPHICS & VIDEO

New ICD Flicker fixer	£209
GVP Impact Vision 24 Bit Card (1500/2000/3000) from	£1550
DCTV (Pal Version)	£440.00
Rocgen	£89.95
Rocgen +	£124.95
Rendale 8802	£119.95
Rendale 8806 RGB	£499.00
Commodore 2300 Int	£99.00
G2	£575.00
G2+	£999.00
Video Pilot V330 (Video Editing)	£1291.33
Philips Editing System	£399.00
AVIDEO 24	
24-bit graphics for the A500- 16.8million colour frame buffer.	£589.00
NEW 24 BIT OPAL CARD	
24-bit colour. 16.8 million colours.Full animation. Fits all Amigas	£634.99

MAIL ORDER HOTLINE: PHONE 071 580 4259

MAIL ORDER HOTLINE: PHONE 071 580 4259



DIAMOND ARE THE No 1

DEDICATED GAMES CENTRE IN BASEMENT



FOR ALL THE TOP GAMES

AT OUR TOTTENHAM COURT ROAD BRANCH

Wolf Child £5	Thunder Hawk £5	Live & Let Die £5	Rick Dangerous £5	Trivial Pursuit £5	Shufflepuck Cafe £5	Data Storm £5	Kid Gloves £5	Corporation £5	Teenage Turtles £5	Gunship £5
Asterix £5	Drivin' Force £5	On Slaughter £5	Rock 'N' Roll £5	E-Motion £5	Predator £5	Monty Pythons £5	Predator 2 £5	Cadaver £5	Back to the Future III £5	M.Reids Pop Quiz £5
Chess Player 2150 £5	Torvak The Warrior £5	Pipe Mania £5	F-19 £5	Dungeon Quest £5	Tower of Babel £5	Power Play £5	Carv-Up £5	Line of Fire £5	Gazza II £5	Grand Monster Slam £5

ANY FIVE BUDGET TITLES FOR ONLY £20 OR £5 EACH

CAPTAIN DIAMOND'S CELEBRATION PARTY PRICES

DESERT STORM
ONLY £17.99

ZOOL
ONLY £14.99

STREETFIGHTER 2
ONLY £15.99

PREMIER MANAGER
ONLY £14.99

CLUB MEMBER SPECIAL

Why not join Captain Diamond's Discount Club and save a fortune on all your games

Personal callers only
Normal saving off RRP

25%

Normal Price is £10 per year
BUT FOR THE 1st 1000 CUSTOMERS IT'S

FREE

AS A CELEBRATION OF THE CAPTAIN'S 100,000th

MEMBER JOINING HIS CLUB, AND HIS 2 NEW SHOPS IN SLOUGH & PORTSMOUTH

PERSONAL CALLERS ONLY
BRING THIS ADVERT WITH YOU

SENSIBLE SOCCER
ONLY £14.99

SLEEPWALKER COMIC RELIEF SPECIAL
ONLY £18.99

WING COMMANDER
ONLY £19.99

LEMMINGS 2
ONLY £17.99

LEGENDS OF VALOUR
ONLY £23.99

ALIEN 3
ONLY £17.99

ZOOL, PINBALL, STRIKER, TRANSWRITE WORDPRO
£29.95 COMPLETE
OR £15.00 EACH

REACH FOR THE SKIES
ONLY £17.99

CLUB MEMBERS PRICE ONLY (Prices are already discounted)



Printer Driver Disk for your Amiga, £5.00 (Please specify model)

You Can't Buy Printers Cheaper Than Diamond



BJ10EX
£186.83



OKI 410
£680

Oki 400 0.5Mb only £527.57

SP 1900+
£108.10



H.P. DESK JETS
500 Mono £316.08
500 Colour £399.49
550 Colour £512.30

OTHER BARGAINS OF THE MONTH



H.P. Best UK Prices

- HP Laserjet IIIp only **£739.08**
- Citizen Swift 240 Colour only **£256.15**
- Panasonic KXP 2123 Col. only **£197.40**
- Epson LX 400 only **£108.10**
- NEC P20 only **£196.22**
- Star LC 100 Colour only **£151.58**

H.P. Laserjet IV
£1232.58

DOT MATRIX PRINTERS		LASER PRINTERS		PRINTER PERIPHERALS						
STAR LC20	£122.69	CITIZEN SWIFT 9 COL	£151.57	2 way Switch Box	£19.95					
STAR LC100 Colour	£151.58	NEW CITIZEN SWIFT 200	P.O.A.	4 way Switch Box	£29.95					
STAR LC 200 Colour	£185.06	CITIZEN SWIFT 224 COL	£205.00	Centronics / Centronics Cable	£14.95					
STAR LC 24-20	£175.95	CITIZEN SWIFT 24E COL	£235.00	PAPER						
STAR LC 24/200 MONO	£203.57	CITIZEN 240 COL	£256.15	500 shts 100 gsm	£7.95					
STAR LC 24/200 COL	£259.09	CITIZEN SWIFT 24X	£303.15	1000 shts 60 gsm	£9.95					
STAR ZA 200 COL	£314.60	CITIZEN SWIFT 24X COL	£348.99	1000 shts 90 gsm	£14.95					
STAR XB 24 200 COL	£400.97	SEIKOSHA SP 1900+	£108.10	2000 shts 60gsm	£14.95					
STAR XB 24 250 COL	£474.99	SEIKOSHA 2400	£129.95	Printer starter kit : Includes paper, ribbon, Printer stand & cable	£29.95					
		SEIKOSHA SL92	£174.99	Printer Driver Disk	£5.00	Dust cover	£4.95			
		New Seikosha 24 Pin Col	£175.08	Printer Stand	£7.95	Printers Inside Out Amiga Book	£19.77			
INK JET PRINTERS				PARALLEL LEADS						
HP DESKJET	£316.08	Oki 400	£527.57	1 Mt	£9.95					
HP DESKJET COL	£399.49	NEW Oki OL410 1Mb inc. HP IIIp Emulation	£680	1.8 Mt	£14.95					
HP DESKJET 550C	£512.30	OKI LASER 810	£939	2 Mt	£16.95					
CANON BJ10EX	£186.83	OKI LASER 830	£939	3 Mt	£19.95					
CANON BJ 20	£287.87	Postscript 2Mb	£939	5 Mt	£24.95					
CANON BJ300	£326.65	NEW OKI OL 850. (Feature enhanced OL840)	£1499	10 Mt	£29.95					
CANON BJ200	£339.58									
CANON BJ330	£442.97									
				PRINTER		TYPE	BLK X2	BLK X6	COL X2	COL X6
				SEIKOSHA SL1900/2400	BLK	£15.98	£43.15	N/A	N/A	
				SEIKOSHA SL90	BLK	£11.98	£32.35	N/A	N/A	
				CANNON BJ10EX	BLK	£43.98	£118.75	N/A	N/A	
				HP DESKJET	BLK/COL	£49.98	£134.95	£49.98	£134.95	
				PANASONIC 2180	BCK/COL	£15.98	£43.15	£29.98	£80.95	
				OKI 400/410/810/830/840	BLK	£49.98	£134.95	N/A	N/A	
				CITIZEN9/24e/200/224/240	BLK/COL	£11.98	£32.35	£29.98	£80.95	



THE DIAMOND PRICE - PLEDGE

If, whilst buying goods from us, you can show us a better price for the same goods in stock with one of our UK competitors then we will match it.

This pledge applies only to customers relying on this advertisement before the 10th day of the month of publication. It does not apply to competitors prices offered in closing down or stock clearance sales.

JAMES STEVENSON 1992

We also take Amiga's in PX against PC's, come in for a demo.

P/X your old 500 for a new Amiga 1200. With Workbench 3.00 1200 is only £299.95 ALL PRICES INCLUDE VAT



Part exchange ex demo A500 with 3 months warranty, £199.95 Ex demo A590's from £199.95 ALL PRICES INCLUDE VAT

10 Disks in a library case £5.00

CAPTAIN DIAMOND'S PERIPHERALS PAGE

APPLICATION

Graphics & Digitising	
Deluxe Paint IV	\$59.99
Digi view Media Station	\$119.00
Expert Draw	\$48.99
Expert 4D Jnr	\$36.99
Flexidump Printer Utility	\$30.99
Intro CAD Plus	\$64.99
X CAD 2000	\$89.99
X CAD 3000	\$239.99
Image Master	\$106.99
Image Finder	\$39.95
Vista	\$18.99
Pro Vista (2Mb Required)	\$61.99
Make Path for Vista	\$27.99
VIDI Amiga Col.Solution	\$99.00
Pix Mate	\$68.99
Pro Draw 3	\$68.95
Turbo Print	\$38.99

Music, Midi & Sound

Audio Engineer +2	\$158.99
Audiomaster 4	\$42.99
Bars & Pipes Pro	\$174.99
Clarity 16 Sampler	\$104.99
Deluxe M. Construction	\$48.99
Digital Sound Studio GVP	\$44.99
Dr T Copiest Apprentice	\$69.99
Dr T KC5 Level II V3.5	\$179.95
Music X 1.1	\$44.95
Music X Junior	\$11.99
Stereo Master	\$29.95
Pro Midi 2 Interface	\$19.99
Super Jam	\$78.99
Techno Sound Turbo	\$34.99

Video Titling

Adorage	\$60.99
Amiga Vision	\$18.99
Big Alternative Scroller	\$39.95
Broadcast Titler 2	\$174.99
Font Pack 1 for above	\$74.99
Font Pack 2 for above	\$74.99
Pro Video Post	\$174.99
TV Show	\$49.99
TV Show Pro	\$59.99
TV Text Pro	\$69.95
Video Director	\$99.00
Video Master	\$48.99
Can Do V1.6	\$74.99
Show Maker	\$149.00
Scala 500	\$69.99
Scala Pro	\$175.00

Animation & Rendering

Art Dept.	\$44.99
Art Dept Pro 2.1	\$128.95
Imagine 2	\$118.99
Map Master for Imagine	\$44.99
Morph Plus	\$148.95
Presentation Master	\$169.95
Surface Master/Imagine	\$24.99
Real 3D Beginners	\$84.99
Real 3D Pro	\$229.95
Sculpt Animate 4D	\$199.95

SOFTWARE

Wordprocessing & DTP	
Transwrite	\$19.99
Kindwords 3	\$34.99
Final Copy V2	\$64.95
Wordsworth V2	\$79.95
Excellence 3	\$79.95
Home Office Kit	\$49.95
Hot Links	\$47.99
Pagesetter 2	\$38.99
Pagesetter 3	POA
Page Stream 2.2	\$125.99
Pen Pal 1.4	\$38.99
Saxon Publisher	\$159.95
Propage 3	\$98.95
Protex V4.3 W/P	\$38.99
Protex V5.5 W/P	\$73.99

Development & Utilities

AMI Back	\$38.99
Amiga Upgrade 2	\$76.99
AMOS Starter Pack	\$39.95
Easy AMOS	\$24.99
AMOS 3D	\$29.99
AMOS Compiler	\$24.99
Cross Dos V5	\$24.99
Dos 2 Dos	\$24.99
Disk Master	\$34.99
Dev Pack 3	\$49.95
Directory Opus	\$24.99
Lattice C 5.1 Dev Syst	\$159.95
Opus Directory	\$25.99
Quarter Back V5	\$31.99
Quarter Back Tools	\$36.99
NEW Superbase	\$189.95
X Copy Pro 5.2	\$29.95
Hi Speed Pascal	\$69.95
Hyper Book	\$39.99

Accounting

Home Accounts 2	\$34.99
Interspread	\$23.99
Mini Office	\$41.99
Personal Finance Mngr	\$28.99
Platinum Works	\$38.99
System 3	\$39.99
Arena Accounts	\$89.99
Pro Calc	\$99.99
Advantage	\$34.99
Day By Day	\$24.99

Educational

A D I Maths 11-12	\$19.95
A D I Maths 12-13	\$19.95
A D I English 11-12	\$19.95
A D I English 12-13	\$19.95
A-Talk Comms S/W	\$9.50
NEW Distant Suns	\$38.95
Fun School s (Each)	\$19.95
GB Route Plus	\$44.95
GP FAX S/Ware	\$38.99
Gallery M/M Dbase	\$43.99
Child's Play Word/Pro	\$23.99

JOYSTICKS

CHEETAH *ALIEN 3	\$12.99
CHEETAH *BART SIMPSON*	\$12.99
CHEETAH *BUG*	\$13.99
COMP PRO EXTRA (CLEAR)	\$10.99
COMP PRO STAR EXTRA	\$14.99
GRAVIS JOYSTICK -AMIGA OR ATARI ST WITH FOAM PADDED GRIP, ADJUSTABLE HANDLE TENSION & PROG FIRE	\$23.99
FREEWHEEL STEERING (DIGITAL)	\$26.99
LOGIC 3 SIGMA-RAY	\$11.99
QUICKJOY JET FIGHTER	\$11.99
QUICKJOY TOP STAR	\$11.99
QUICKSHOT 155 AVIATOR 1	\$22.99
QUICKSHOT 137FPYTHON	\$9.99
QUICKSHOT 127 STARFIGHTER REMOTE	\$29.99
TWO INFRA-RED JOYPADS	\$12.99
QUICKSHOT 128FMAVERICK 1	\$22.99
QUICKSHOT 149INTRUDER 1	\$11.99
QUICKSHOT 111A TURBO 2	\$11.99
QUICKJOY QJ1 JOYSTICK	\$11.99

Convert your IBM Joystick to work with your Amiga \$9.99

POWER SCANNERS

With the latest Version 2 software for bright & sharp grey scale performance. Flexible scanned image display manipulation option, plus Clean up, Embolden, Re-size & Flip. **Mono only \$93.99 Colour \$228.99**

Epson GS6000 Col Flatbed \$798.99

Golden Image Hand Scanners
Features 400 dpi 256 Greyscale, Touch-up & Merge it software

Alfa Scan \$123.99
Alfa Scan Plus \$148.99
Alfa Scan OCR (Inc S/W) \$278.99

ADG Software
Can be intergrated into art development or as stand alone programme. \$108.99

AMIGA BOOKS

GIANT BOOK SALE AT OUR TOTTENHAM COURT ROAD, LONDON, BRANCH FANTASTIC TITLES AT SILLY PRICES

Advanced S. Prog. Guide	\$17.10	Disk Drives Inside & Out	\$14.65
3D Graphics Prog. Basic	\$9.75	Amiga For Beginners	\$9.05
Amiga Basic Inside & Out	\$12.20	Graphics Inside & Out	\$17.10
Amiga C Advanced Prog.	\$17.10	Machine Language	\$9.75
Amiga C for Beginners	\$9.75	Printers Inside & Out	\$17.10
Amiga DOS Inside & Out	\$9.75	Systems Prog. Guide	\$17.10
Amiga Dos Quick Ref.	\$4.85	Best Tricks & Tips	\$9.75
Desk Top Video Guide	\$9.75	Making Music On Amiga	\$17.10

HOW TO ORDER

Simply telephone through your order, giving your Access, Visa or American Express card number (AMEX has a 3% surcharge), or send a cheque or postal order to our Tottenham Court Rd. Branch

MAIL ORDER Phone.071 580 4259. Minimum Courier Service \$17.63

Corporate Sales:-Account Customers Min. order value = £50, New Accounts min. £500. Allow 10 working days for cheque clearance. Bankers drafts clear same day. All prices are correct at time of going to press but are only valid until the 10th day of month of publication due to magazines coming out four weeks earlier than issue cover date. ie. This advert is only valid until 10th March 1993

THE DIAMOND PRICE PLEDGE

If, whilst buying goods from us, you can show us a better price for the same goods in stock with one of our UK competitors then we will match it.

This pledge applies only to customers relying on this advertisement before the 10th day of the month of publication. It does not apply to competitors prices offered in closing down or stock clearance sales.

DIAMOND SHOPS AROUND THE UK

AMIGA WORLD In the basement of 232 Tottenham Ct Rd London W1 Tel 071 580 4355 FAX 071580 4399	HEAD OFFICE 84 Lodge Road Southampton Tel 0703 232777 FAX 0703 232 679	443 Gloucester Rd Bristol Tel 0272 522044 FAX 0272 521738
NEW SHOWROOM 410 Bath Rd Slough Tel 0628 604555 Fax 0628 668952	1022 Stockport Rd Manchester Tel 061 257 3999 FAX 061 257 3997	Amiga Centre 1063 High Rd Chadwell Heath Romford Tel 081 597 8851 FAX 081 590 8959
144 Ferry Road Edinburgh Tel 031 554 3557 FAX 031 554 2115	406 Ashley Road Poole Dorset Tel 0202 716226 FAX 0202 716160	NEW SHOP OPENING IN PORTSMOUTH Tel 0703 232777 for details

LONDON CORPORATE SALES Saran Duffy 071 5804355 Fax 071 580 4399

CLUB MEMBERS PRICE ONLY
(Prices are already discounted)



THE NAMES YOU CAN TRUST

Month after month, the games reviewers at *Amiga Format* scrutinise every game that's released on the market, and bring you the most honest and unbiased reviews around. Unlike our competitors, we'll never review an unfinished game just so we can shout "exclusive" at you. OK, so that means that we're sometimes last to review games, but if we manage to stop one of you buying a rubbish game, then our job is made worthwhile.

We've all been in your situation before, and we've all had our fingers burned buying poor-quality games. This is why we at *Amiga Format* pride ourselves on three golden rules:

- (1) If it's not finished, it doesn't get reviewed.
- (2) If it's crap, we say it's crap - and it doesn't matter what the softies think of us.
- (3) If we're forced to take sides, it's always your side we take.

THE REVIEW CREW

TRENTON WEBB

"*History Line 1914-1918*, without a doubt. Any game that teaches you the wonders of heavy artillery can't be all bad..."

JAMES LEACH

"Playing Trenton at *History Line 1914-1918*. I like it because the assassination of Archduke Ferdinand at the hands of my Great Uncle precipitated the start of WW1. I'm so proud of him."

ANDY NUTTALL

"Oh blimey, erm, well... it's got to be *Sensible Soccer 92/93*. That way I can pretend that it's real life and Liverpool are going to win the League."

PAT MCDONALD

"I've spent a lot of time playing *Exodus* lately, and to be honest I wish I hadn't bothered! I do like the jokes, though. Who says the Germans don't have a sense of humour!"

ANDY HUTCHINSON

"*Indiana Jones and The Fate of Atlantis* - the graphic adventure. I've got a thing about whips and leather chaps, you see." Erm, yes Andy.

ED RICKETTS

"Hmmm. I'll have to say *Tearaway Thomas*, I'm afraid - even though it's unimaginative and derivative." Wise words, mate.

SARAH TANSER

"I've recently revived the great belly-wobbling platformer *Chuck Rock.*, because it reminds me of an old friend."

HUW LLEWELYN

"I've been playing loads of games on my Amiga lately. Oh, erm, hi Mum, didn't see you there. Yeah, like I was saying - I've been studying madly for my exams. Honest."

DEREK DAVIS

"*Knights of the Sky*, I reckon. It's great at first, but it gets a bit too difficult for its own good on the later levels."

ANDY LOWE

"*Streetfighter 2*, because it improves your hand-eye co-ordination, and gives you a great feeling of power as you punch someone's head in."

NEIL JACKSON

"I've been busy scaring myself to death by playing *Dark Seed*. It's giving me nightmares - but I've just got to finish it."

Screenplay

The time of Valentine is upon us once again, and people all over the country are posting cards to ones they love. If you don't get one, never mind - cheer yourself up by treating yourself to a new Amiga game. Which one? Read on...

WAKE UP! TIME TO PLAY...



Sleepwalker

What do you get if you cross Comic Relief, Ocean Software, a brilliantly original idea from CTA Developments and a small dog called Ralph? That's easy - you get our game of the month, *Sleepwalker*. But why is it so good? Well, you'll just have to turn to our review on... **Page 60**



Legends of Valour

Once upon a time in the fairy-tale village of Mitterdorf there were lots of robbers, gamblers, werewolves, vampires, trolls, goblins and some heavy-handed police, all of whom were in a bad mood all of the time. Into this lovely town came a naive adventurer with leather trousers, a rucksack and a bad case of spots. How will the adventurer get by? Find out on... **Page 90**



Wing Commander

With its texture-mapped graphics and incredible speed, *Wing Commander* caused a storm when it was unveiled to the PC market a year ago. The PC version required a fast machine with loads of add-ons to run, so there were many sceptics when it was announced that an Amiga conversion was on the way. Can Origin prove them wrong? Turn to... **Page 94**



Dragon's Lair III

Good grief! Sullivan Bluth's bizarre and wacky arcade game makes it to part three on the Amiga. Who'd have thought it, especially as the previous two incarnations were as about as playable as ice hockey in the Sahara. Still, we have to give them a chance - they might have got it right this time, third time lucky and all that! Find out for sure by reading our daring exposé on... **Page 98**



Dark Seed

With graphics drawn by Swiss surrealist HR Giger, famous (or infamous?) for his monstrous creations in the film *Alien*, this offering from newcomers Cyberdreams looks set to sell in vast quantities. But as readers of *Amiga Format* know, sexy graphics don't always make a sexy game. Can the story match the visuals? We spill the beans on... **Page 68**

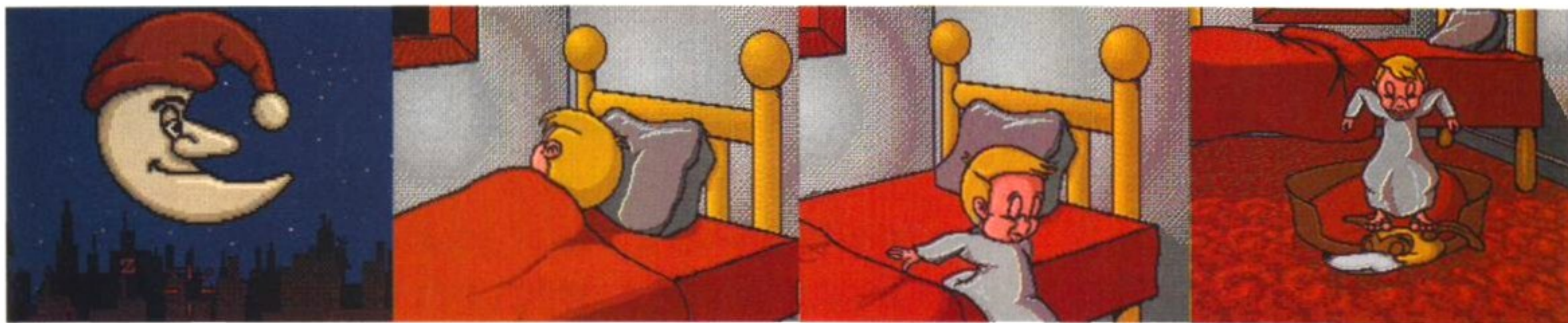

The story behind *Sleepwalker* goes something like this: midnight and all's well... Mr. Moon is getting ready to go to bed, and the whole town of Kipsville is fast asleep.

Lee, the subject of this tale, is prone to a bit of sleepwalking now and again - fortunately his dog, Ralph, wakes up at the slightest hint of someone treading on his head!

AMIGA FORMAT



Ocean have had a bad run recently, with the release of *Cool World* and the appalling *WWF 2*. But their latest game heralds a return to form, with the help of a dog called Ralph...

Sleepwalker

60

MARCH 1993

If somebody said to you that they had come up with an idea for a game which is incredibly simple, and yet maddeningly addictive, it would be difficult to believe them with today's style of games. With the range of platform games, shoot-em-ups and adventures which flood the games market, it takes a clever mind to think up an original idea.

Sleepwalker, the latest game from Ocean, is exactly that sort of game. It has the kind of storyline that makes you kick yourself and shout "why didn't I think of that!" The storyline goes: a boy sleepwalks his way through the major hazards of a city, while you control his dog in an attempt to stop him waking up. If the boy hits an obstacle, he loses some sleep. That's it, the complete story. So why the hell hasn't someone thought of that before?

Anyway, someone has now, so it's too late. It would be a real bummer, though, if the



Now look, nice little boys like you don't usually want to walk into furnaces. It's just not done. Why don't you come along with me now and help me play with some parked cars?

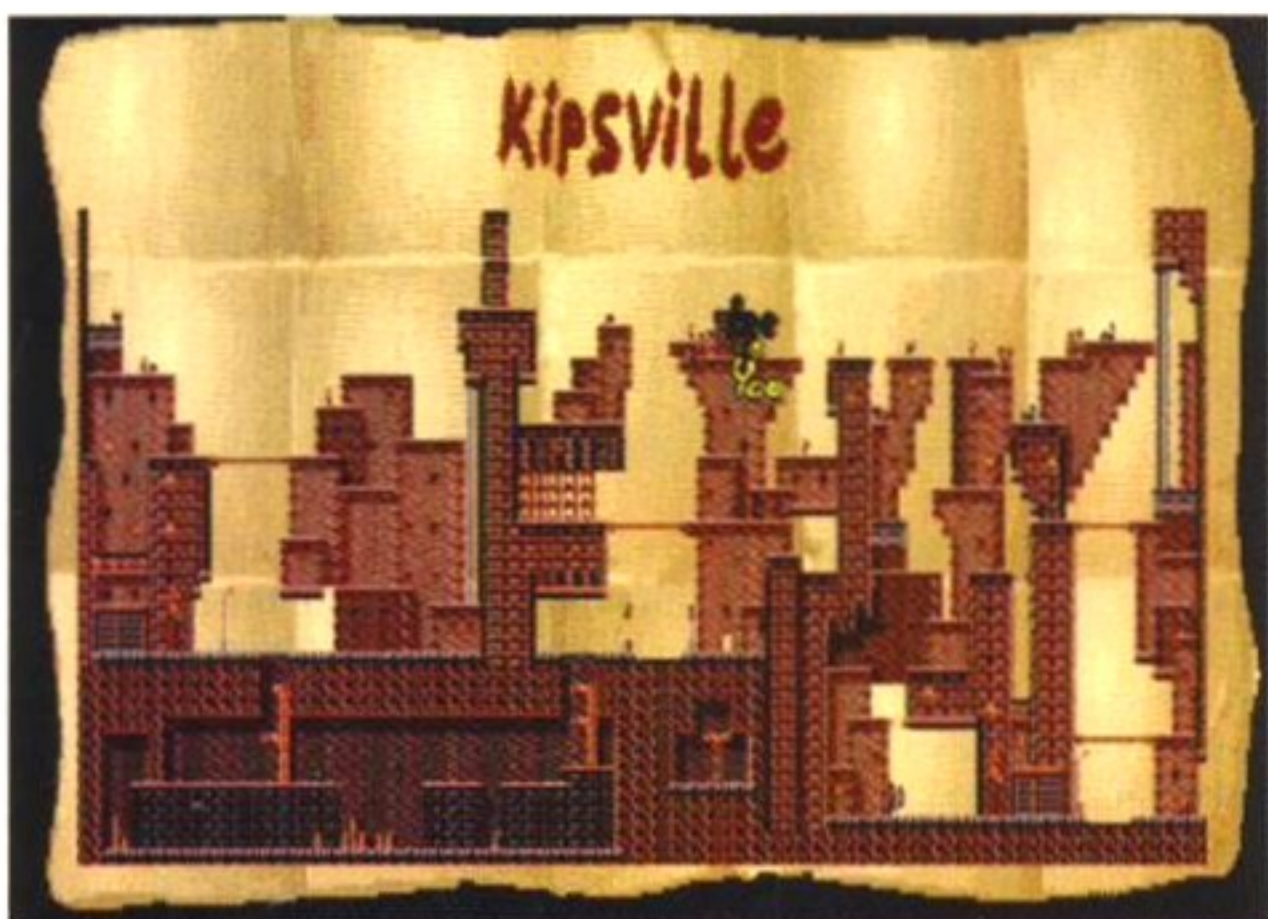

"You are here." The map facility comes in very useful - problem is, only the places you've visited are marked. Can anyone direct me to the exit?

game turned out to be a dog. After all, £4.32 from each sale of the game goes to Comic Relief, so hopefully it will be good enough for you to want to go out and buy it. Fortunately for Ocean, Comic Relief, and you, the prospective buyer, *Sleepwalker* is actually very good.

Sleeping dogs lie...

The sleepwalker in question here is called Lee. His mum carelessly leaves Lee's window wide open at bedtime, and so (of course) he somnabulates his way out of it. On his way he manages to tread on his dog, Ralph, and the

faithful hound takes it upon himself to keep Lee from harm.

Lee continues walking and walking until he reaches some kind of danger, and if this danger happens to be, for instance, the edge of a rooftop, a nightclub bouncer or even an open sewer, he will just merrily wade in and take the damage as it comes. As he gets more and more hassle, he loses more and more sleep - and if the little chap awakes from his slumbers you lose a life. Got that so far?

OK, so how does Ralph protect him? Fortunately, he's a big, strong dog who's able

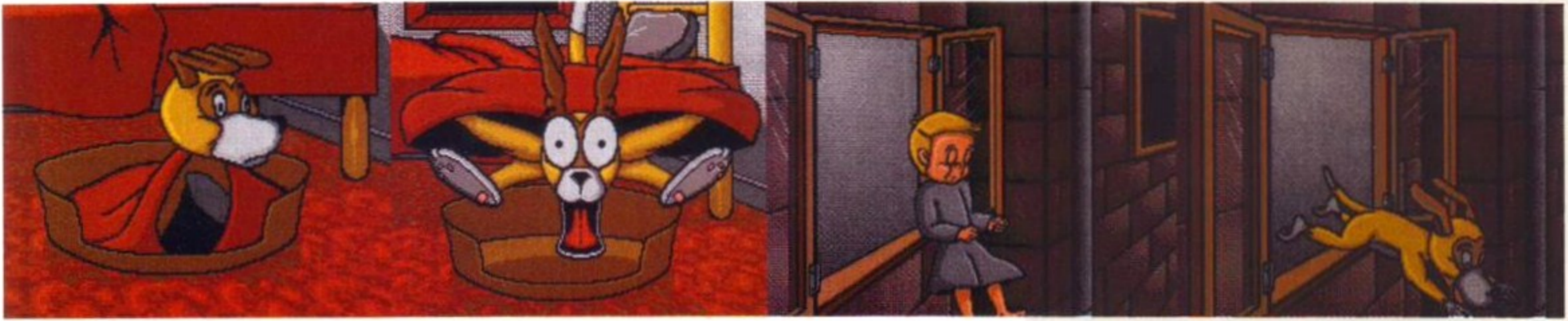

Unusually alert for this time of night, Ralph looks around wondering what has just flattened him – and realises (with some distress) that the bedroom window is open...

Lee hops out of the window and begins to noctambulate his way around the town. Good old Ralph goes headfirst after him – and control of the dog goes over to you...

to push and kick Lee around without too much effort, and he's also armed with a truncheon (which helps against the bad guys). Generally, though, Ralph's job is to run around and find the places where Lee is likely to get hurt, and make them safe. The screen's scrolling always follows Ralph around, so it's quite possible to lose track of Lee's position – and this is where the strategic part of the game comes in.

When you run away to disarm the danger, you must always keep an eye on Lee. The way he manages to get himself into trouble is quite amazing – but kind old Ocean have provided an on-screen map to help you along. When you view the map, time stops, so you can have that cuppa or go to the loo.

RED NOSE!

Is life really that simple? 'Course not, silly – the map only displays the places where you've already been, so you're constantly running blind. You have to check all directions – dead-ends, tunnels, sewers – in the hope that you're going the right way. If you really need the map to plan your strategy, you'll have to find a dunce's cap and pick it up – this fills out all the missing pieces of the map.

While we're on the subject of pick-ups, there are several other bits and bobs lying around which will help you on your travels. These include a red nose – extra life; a whoopee cushion – invulnerability; and a custard pie – builds a bridge over water. Also

"Two spikes would be an extravagance." Lee, in his own inimitable style, manages to uncover the only trap in the level which I'd overlooked... Damn.



scattered around each level are five bonus noses. As you collect them, the word COMIC is spelled out on the top right-hand side of the screen – collect them all, and you can enter the bonus level – see following page 'Give the dog a bone-us'.

Control of Ralph is via a joystick – and preferably one which can cope with diagonals easily. If you walk into Lee face on, you will stop him; carry on, and you'll push him in the other direction. If you're pushing Lee, or any other object for that matter, you can swap positions by pulling down on the stick. Stand behind Lee and press the fire-button, and

you'll kick him upwards on to a higher platform. The control method is very simple, but difficult to master – in fact, that statement could easily apply to the whole game, and it's one of the trademarks of a classic.

After playing *Sleepwalker* for a while, you begin to realise the scale of the game, and also the amount of fun that the creators must have had in putting it together, and playtesting it all. They have obviously got a good sense of humour – when Ralph runs off the edge of a building he hangs there for a while, then looks down, grimaces, yelps and only then does he

Continued overleaf

LET ME TAKE YOU BY THE HAND, AND LEAD YOU THROUGH THE STREETS OF KIPSVILLE...



Level 1: Kipsville. Leap from roof to roof while walking tightropes and dodging radioactive waste.



Level 2: Zoo. Stand on the back of giraffes while observing the interesting flora and fauna.



Level 3: Graveyard. Under no circumstances should you wave your socks in Lee's face.



Level 4: Construction Works. Electricity can be dangerous for small dogs and young children.



Level 5: Factory. Lee seems to have a passion for fur-naces – use all your might to stop him...



Level 6: Kipsville Returns. Dodge the noisy alley cats, and remember – keep off the grass...

GIVE THE DOG A BONE-US

If you manage to collect five red noses from each of the first five levels, you will be transported to one of five bonus levels. Here, you must collect three items which spell out a phrase – which Ralph then uses as a form of revenge on Lee...



Aw, this one is easy. All you need to find are a + sign and a - sign, and you're well away. Can you see what it is yet?

HONEY POT - POT + BEE = HONEY BEE

Simple, yes? Now Lee will find himself in a nightmarish situation involving being stung by a bee.



Now this one's even easier. Come on, no clues – you must be able to get this one. I'm waiting... right, got it now? The answer is...

ACT + ION + MAN = ACTION MAN

OK, got the hang of it now? Well let's give you one more example, just to be on the safe side.



You need to collect the objects in order, with the mathematical signs in-between. In this case, that means collecting...

LAMP + POST BOX - BOX = LAMP POST

Lee will come to a fateful end – but don't worry, it's only in your dreams.

drop. Further on in the game you're likely to find him being burned, steamed, electrocuted, squashed, sauteed – you name it, it happens. In case there are any children reading, you needn't worry – Ralph is never hurt, only delayed by these horrible accidents. Other neat touches that endear you to Ralph include the way in which he leans against a wall for a breather when you leave him alone, and his teetering motion when he stands right on the edge of a huge drop.

Yes, comedy abounds everywhere – but then so does cruel humour. The options screen at the start of the game gives you the chance to select either easy or hard gameplay, but selecting easy simply lures you into a false sense of security. The game could never, under any circumstances, be called easy. Don't get the wrong impression, it's not too difficult either – it's a good balance between the two. Anyway, to introduce you to the game a small training level is provided, with arrows and messages on screen to point you in the right directions.

Phew!

Sleepwalker is one of those games that is addictive, testing and madly infuriating when you go wrong. You need to have a quick-thinking mind to keep track of Lee while you rush about discovering the danger points. It's not really a case of 'Oy Lee, stay there while I



Ah yes, Lee gets his comeuppance in the shape of a lamp post – while Ralph laughs in the wings.

go ahead and sort that trouble out,' because Lee is constantly on the move. He walks quickly, but Ralph is able to jump ahead of him and rush around much faster – so it's all down to your dexterity and concentration.

Sleepwalker is a brilliant mix of arcade, puzzle, strategy and platform styles; but what sets this apart from the rest is that all these elements are mixed together so well that you can't see the join. The graphics are so good-looking and varied, with excellent use of



After completing a level, you are given your score, and level of comedy achieved (zilch).

parallax scrolling, that sometimes it's almost possible to believe that you're taking part in an interactive cartoon.

Games like this don't come round very often: *Sleepwalker* is original, playable and good-looking, with superb sound effects and music, and large enough to keep you playing for ages – I'm gobsmacked. Buy it, but don't borrow it or steal it – that's cheating. Remember, it's for charity, mate

Andy Nuttall

RALPH, THE KAMIKAZE STUNT DOG

While chasing after his master, Ralph gets into some extraordinary situations – and each of them are represented by some stunningly cute animations. Falling and leaping are two of the most common, along with being burnt, squashed and electrocuted...



He's just hanging around... Ralph makes a bridge so his master can walk all over him.



Ralph, being a quality actor, can even make teetering on the edge of a vast precipice look fun...



Being pushy is just one of Ralph's many talents. Few canines would be able to handle Lee like this.

Sleepwalker Ocean ■ £25.99

- Wow! How many different genres can you fit into one game?
- Cute cartoony graphics using parallax scrolling, and six completely different levels.
- Five brain-taxing bonus levels, where the ability to think laterally is a huge bonus.
- Weird, almost random music – along with excellent sampled effects and speech.
- Not just a charity licence – a completely playable, exciting, puzzling game. A winner!



91%

GUNSHIP™ —2000—

Bringing the battle to your Amiga



MICRO PROSE®
Seriously Fun Software



MicroProse Ltd. Unit 1 Hampton Road Industrial Estate, Tetbury, Glos. GL8 8LD. UK. Tel 0666 504 326.

Wolfpack £7.99

0908 379550

HEIMDALE ONLY
£12.99

- Flight of the Intruder£9.99
- Football Crazy£12.99
- Lure of the Temptress£14.99
- Robocop 3£14.99
- Super Fighters.....£14.99
- Chuck Rock£7.99
- Mercenary 3£5.99

**Ultima
V only
£7.99**

- Jimmy White Snooker£14.99
- Dune£14.99
- Dream Team.....£14.99
- Silk Worm£5.99
- Jaguar XJ220£9.99
- Thunderhawk£9.99
- WWF2 - Euro Rampage£14.99

BLANK DISKS

100% CERTIFIED FULLY GUARANTEED

20£8 100£30
50£17 250£70

(PLEASE ADD £3.00 P&P ON ALL BLANK DISK ORDERS)

FOOTBALL CRAZY

KICK OFF 2/PLAYER MANAGER/FINAL WHISTLE

ONLY £9.99

Dungeon Master Only £9.99

- | | | | |
|------------------------|-------|-----------------|-------|
| AUNT ARCTIC ADVENTURE | £5.99 | PREDATOR 2 | £5.99 |
| PAPERBOY 2 | £6.99 | MEGALOMANIA | £8.99 |
| NARC | £5.99 | GREMLINS 2 | £5.99 |
| UNTOUCHABLES | £5.99 | MIGHTY BOMBJACK | £5.99 |
| FLIGHT OF THE INTRUDER | £9.99 | MOUSE MATS | £2.00 |
| MEGA BLASTER JOYSTICK | £5.99 | PHOTON PAINT 2 | £7.99 |
| NIGHTBREED | £5.99 | NAVY SEALS | £5.99 |
| FIGHTER JOYSTICK | £5.99 | WILD WHEELS | £5.99 |
- (FULLY MICROSWITCHED, 2 FIRE BUTTONS)

**LANGUAGE
LEARNING
PACK**

SPANISH TUTOR
FRENCH MISTRESS
GERMAN MASTER
ITALIAN TUTOR

RRP £19.99
RRP £19.99
RRP £19.99
RRP £19.99

**ALL 4 FOR
ONLY £19.99**

**10 GREAT
GAMES
£9.99**

**ZYDEC
EXTERNAL DRIVE
£49.99**

- | | | | |
|--|---|---|--|
| A320 Air Bus.....21.99 | Dyna Blasters.....19.99 | Knights of the Sky (1 Meg).....32.99 | Robocop 3.....£14.99 |
| Addams Family (1 Meg).....15.99 | ELF.....18.49 | Last Ninja 2.....5.49 | Rolling Ronny.....£9.99 |
| ADI English (11-12).....18.99 | Elvira 2 - Jaws of Cerberus(1 Meg).....22.99 | Leander.....10.99 | Rome.....£19.49 |
| ADI English (12-13).....16.99 | Espana - The Games 92 (1 Meg).....19.49 | Leisure Suit Larry 3 (1 Meg).....25.99 | Rookies.....£16.99 |
| ADI Maths (11-12).....15.99 | Exile.....18.49 | Lemmings.....12.49 | Rook's Drift.....£15.99 |
| ADI Maths (12-13).....16.99 | Eve of the Beholder (SSI)(1 Meg).....19.99 | Lemmings 2.....20.99 | Rugby World Cup.....£7.99 |
| Advantage Tennis.....16.99 | Eve of the Beholder 2 (1 Meg).....23.99 | Lemmings Data Disk - Oh No!.....9.99 | Sabre Team.....£15.99 |
| Agony.....10.99 | F16 Strike Eagle 2 (1 Meg).....14.99 | Lethal Weapon.....18.99 | Scrabble De Luxe.....£19.99 |
| Air Bucks.....17.99 | F10 Stealth Fighter.....14.99 | Lombard RAC Rally.....8.49 | Scribble Word Processor.....£24.99 |
| Air Sea Supremacy (Gunship, Silent Service, P47, Wings, Carrier Command).....19.99 | Fables & Frenzy-Legend of Kyra.....19.99 | Lotus 3 - The Final Challenge.....17.49 | Secret of Monkey Island (1Meg).....£18.99 |
| Air Support.....16.99 | Fantastic Worlds (Realms, Pirates, Mega Lo Mania, Populous, Wonderland).....22.99 | Lotus Turbo Challenge 2.....11.99 | Secret of Monkey Island 2.....£23.99 |
| Alien Breed (Special Edition) (1 Meg).....8.99 | Fantasy Pak (Colorado, Boston Bomb Club, Crystals of Arborea).....13.99 | Lure of the Temptress.....19.99 | Secret of the Silver Blade (1Meg).....£19.99 |
| Allex (Light Phaser Game).....9.99 | Final Copy 2 Word Processing.....69.99 | Magic Pockets.....16.99 | Sensible Soccer.....£18.99 |
| Amnios.....7.99 | Final Fight.....16.99 | Manchester United Europe.....9.99 | Shadow of the Beast 3.....£19.49 |
| Amos (Games Creator).....29.99 | Fire & Ice.....16.99 | Manic Miner.....9.99 | Shadowlands.....£19.49 |
| Amos 3D (Requires Amos).....22.99 | First Samurai & Mega Lo Mania.....13.99 | McDonalds Land.....17.49 | Shadowworlds.....£15.99 |
| Amos Compiler (Requires Amos).....19.99 | Flame of Freedom (Midwinter 2)..... | Mega Sports (Summer games 1 & 2, Winter Games).....16.99 | Shuttle.....£19.99 |
| Amos Easy (First Steps to Programming).....22.99 | Floor 13.....19.49 | Merlins Maths (7-11).....18.99 | Silent Service 2 (1Meg).....£22.99 |
| Amos Professional (The Ultimate Amiga Programming Tool).....44.99 | Formula 1 Grand Prix.....23.99 | Micro English (6 years to GCSE, Conforms to National Curriculum).....19.99 | Sim Ant.....£22.99 |
| Apidva.....16.99 | Fun School 2 (2-5).....7.99 | Micro French (Beginners to GCSE and Conforms to National Curriculum).....15.99 | Sim City & Populous.....£15.99 |
| Aquatic Games.....19.49 | Fun School 2 (6-8).....7.99 | Micro German (Beginner to GCSE and Business, Conforms to National Curriculum).....18.99 | Sim City Ancient Cities.....£8.99 |
| Arabian Nights.....15.99 | Fun School 2 (8+).....7.99 | Micro Maths (11 Yrs to GCSE Conforms to National Curriculum).....15.99 | Sim City Future Worlds.....£8.99 |
| Archer Maclean's Pool.....17.99 | Fun School 3 (2-5).....16.99 | Microprose 3D Golf.....19.99 | Sim City Terrain Editor.....£8.99 |
| Arkanoid 2.....8.49 | Fun School 3 (5-7).....14.99 | Midnight Resistance.....9.49 | Space Crusade.....£12.99 |
| Armatek.....3.99 | Fun School 3 (7+).....16.99 | Midwinter.....15.99 | Special Forces.....£22.99 |
| Armour Geddon.....9.99 | Fun School 4 (2-5).....16.99 | Mini Office (Word Processor, Spreadsheet, Database, and Disk Utilities programs).....38.99 | Speedball 2.....£15.99 |
| Armour Geddon 2.....19.49 | Fun School 4 (5-7).....16.99 | Monster Pack 2 (Killing Game Show, Awesome, Beast 2).....13.99 | Spelling Fair (7-13yrs).....£18.99 |
| Ashes of the Empire.....23.99 | Gauntlet 2.....7.99 | Motorhead.....11.99 | Spirit of Excalibur (1Meg) (NOP).....£9.99 |
| Assassin (1 Meg).....17.49 | Goblinks.....18.99 | New Zealand Story.....8.49 | Starush.....£18.99 |
| AV8B Harrier Assault.....24.99 | Golden Axe.....8.49 | Nesjed Mansell's World Championship.....19.49 | Steve Davis Snooker.....£3.99 |
| B17 Flying Fortress.....22.99 | Golf World Class Leaderboard.....7.99 | Office (Word Processor, Spell Checker, spreadsheet & statistics, Database, Graphics and BasicQTP).....44.99 | Storm Master.....£18.49 |
| Barbarian 2 (Psychosis).....14.99 | Graham Gooch World Class Cricket.....17.99 | Operation Wolf.....8.49 | Strategy Masters (Populous, Hunter, Spirit of Excalibur, Chessplayer 2100, Deuterios).....£19.99 |
| Bat 2.....22.99 | Graham Taylor's Soccer Manager.....18.99 | Page Setter 2.0 DTP.....34.99 | Streetsfighter 2.....£18.49 |
| Batman the Movie.....8.49 | Gunship 2000.....21.99 | Paint 'N' Create (Educational Art Package for Kids over 6 years).....18.99 | Striker.....£18.99 |
| Battle Isle (NOP).....19.99 | Guy Spy.....19.49 | Pang.....8.49 | Stuart Pearce's Soccer Selections (Kick Off 2, Microprose, Soccer, Manchester United, International Soccer).....£19.99 |
| Battle Isle Data Disk.....14.99 | Harlequin.....22.99 | Parabola Stars.....15.99 | Super Hang on.....£9.49 |
| Beach Volley.....8.49 | Harpoon V1.21.....22.99 | Pen Pal Word Processor.....34.99 | Super Hero.....£19.49 |
| Bill's Tomato Game.....15.99 | Head Over Heels.....8.49 | Perfect Dermal.....22.99 | Super Space Invaders.....£18.99 |
| Birds of Prey (1 Meg).....22.99 | Head Over Head.....21.99 | PGA Tour Golf + Courses.....19.49 | Supremacy.....£18.99 |
| Black Crypt.....10.99 | Heart of China (1 Meg).....22.99 | PGA Tour Golf Course Disk.....11.49 | Sword of Sodor.....£6.99 |
| Blue Max.....19.99 | Handball (1 Meg).....11.99 | Pinball Dreams (1 Meg).....16.49 | T.N.T. (APB, Hard Drive, Toobin, Dragon Spirit, Xybots) (NOP).....£7.99 |
| Blues Brothers.....8.99 | Heroquest + Data Disk.....19.49 | Pitfighter.....9.99 | Team Yankee.....£17.99 |
| Breach 2 (Enhanced).....18.49 | Hitch Hikers Guide.....8.99 | Plan 9 From Outer Space.....22.99 | Terminator 2.....£18.99 |
| Business Pack for Amiga - Wordworth Word Processing, K-spread 2, Spreadsheet and K-Data Database.....64.99 | Hollywood Collection (Robocop, Ghostbusters 2, Indiana Jones Action, Batman the Movie) (NOP)..... | Player Manager.....8.99 | The Enforcer (Light Phaser Game).....£9.99 |
| Cadaver.....8.99 | Home Accounts 2.....37.99 | Pools of Darkness.....21.99 | The Lost Treasures of Infocom 1 (20 classic Infocom Titles).....£27.99 |
| Captive.....8.99 | Home Alone.....16.99 | Populous & Sim City.....16.99 | The Manager (NOP).....£19.99 |
| Castles (1 Meg).....19.49 | Hook.....15.99 | Populous 2 (1 Meg).....19.49 | Thunderhawk.....£9.99 |
| Castles Data Disk.....11.99 | Humans.....17.99 | Populous 2 + Data Disk.....21.99 | Titus the Fox.....£9.49 |
| Catsr.....19.49 | Ian Botham's Cricket.....19.49 | Populous 2 Challenge Data Disk.....11.99 | Troddlers.....£15.99 |
| Celtic Legends.....19.99 | Ik+.....8.49 | Power Up (Chase H.Q., Turrican, X-Out, Altered Beast, Rainbow Islands) (NOP).....9.99 | TV Sports Football.....£3.99 |
| Championship Manager.....12.99 | Indiana Jones 2 Adventure (Fate of Atlantis).....23.99 | Powermonger.....19.49 | UGH.....£15.99 |
| Chaos Engine.....19.99 | Indiana Jones Adventure.....9.99 | Powermonger World War 1 Data Disk.....11.49 | Ultima 8.....£12.99 |
| Chart Attack (Lotus, Esprit, Ghoul's 'N' Ghosts, James Bond, Venus the fly trap).....19.49 | Indy Heat.....16.99 | Premiere.....15.49 | Ultima 8 (1Meg).....£19.99 |
| Chuck Rock.....8.99 | Interceptor - Renegade Legion.....10.99 | Prince of Persia (1 Meg).....9.99 | Utopia.....£11.99 |
| Chuckie Egg.....9.99 | International Rugby Challenge.....17.49 | Project X (1 Meg).....£18.99 | Utopia New Worlds Data Disk.....£11.49 |
| Chuckie Egg 2.....9.99 | International Sports Challenge.....10.49 | Protest Version 4.3 Word Processor.....£38.99 | Vikings - Field of Conquest.....£16.99 |
| Civilization.....22.99 | Ishar - Legend of the Fortress.....15.99 | Push-Over.....£16.99 | Vroom.....£15.99 |
| Cool World.....14.99 | Jack Nicklaus Golf.....6.99 | Quest & Glory (Bloodwych, Midwinter, Cadaver, Rat).....£13.99 | Vroom Data Disk.....£12.49 |
| Corruption (M/Scrolls).....3.99 | Jaguar XJ500 (1Meg).....14.99 | Question 2 (SS1).....£4.99 | Walker.....£19.49 |
| Crazy Card 3.....16.99 | James Pond.....7.49 | Ragnarok.....£24.99 | Wheels of Fire (Hard Drive, Powerdrift, Chase H.Q., Turbo, Outrun) (NOP).....£7.99 |
| Creepers.....19.49 | James Pond 2 - Robocod.....18.99 | Railroad Tycoon (1 Meg).....£19.99 | Wing Commander 1.....£22.99 |
| Curse of Enchantia.....17.99 | Jet Set Willy.....9.99 | Rampart.....£15.99 | Wiz-Kid.....£18.99 |
| Curse of the Azure Bond (1 Meg).....17.99 | Jim Power.....18.99 | Reach for the Skies.....£19.99 | Wizardry 8 - Bone of the Cosmic Forge.....£24.99 |
| Cyber Assault (Light PhaserGame).....9.99 | Jimmy White Snooker.....14.99 | Red Baron (1 Meg).....£22.99 | Wolfchild.....£11.99 |
| C-Ytron.....18.49 | John Barnes European Football.....16.99 | Rise of the Dragon (1 Meg).....£25.99 | Wordworth VI 1E ASOOP (Special enhanced 2Meg version with 1Meg upgrade for A500).....£79.99 |
| D-Generation.....10.99 | John Maddens (UB) football.....16.99 | Risky Woods.....£18.99 | Wordworth VI 1E A500 (Special enhanced 2Meg version with 1Meg upgrade for A500).....£94.99 |
| Dark Queen of Kyrin (1 Meg).....21.99 | KGB.....19.99 | Road Rash.....£19.49 | Wordworth Word Processor (1Meg).....£74.99 |
| Darkmere (1 Meg).....15.49 | Kick Off + Extra time disk (NOP).....3.99 | Road Rash.....£19.49 | WWF Wrestling.....£14.99 |
| Death Knights of Kyrin (1 Meg).....19.99 | Kick Off 2 (1Meg).....8.99 | Road Rash.....£19.49 | WWF Wrestling 2.....£15.99 |
| Deluxe Paint 3 (with Animation).....24.99 | Kick Off 2 (1Meg).....8.99 | Road Rash.....£19.49 | Xenon 2 Megablast.....£5.99 |
| Deluxe Paint 4 (1 Meg) (Ham Mode & Animation).....84.99 | Kick Off 3.....9.99 | Road Rash.....£19.49 | Zool (1Meg).....£15.99 |
| Disney Animation Studio.....49.99 | Kick Off 2 Final Whistle.....9.99 | | |
| Doodlebug.....13.99 | Kick Off 2 Giants of Europe.....7.99 | | |
| Dune.....19.99 | Kick Off 2 Return to Europe.....7.99 | | |
| Dungeon Master & Chaos Strikes Back (1 Meg).....19.49 | Kick Off 2 Winning Tactics.....7.99 | | |
| | Kick Off 3.....16.99 | | |
| | Kidstye Junior Word Processor.....14.99 | | |
| | Kind Words 3 Word Processor.....29.99 | | |
| | Knightmare.....19.99 | | |

- 4D Driving.....5.99
- Silkworm.....5.99
- Hunt for Red October 2 ..5.99
- Spritz Paint.....5.99
- The Ball Game.....5.99
- Tetris.....5.99
- Rugby5.99
- Bombozal5.99
- Monty Python.....5.99
- Kick Off 25.99
- Welltris5.99
- Soccer Mania5.99
- Cadavar5.99
- Race Driving.....5.99
- Ant Heads.....5.99
- Navy Seals5.99
- Dark Man5.99
- Player Manager5.99
- Viz.....5.99
- Continental Circus5.99
- Chronquest 2.....5.99
- Magnetic Scrolls Collection (3 Games).....5.99
- Xenon 2.....5.99

EDUCATIONAL

- SHAPES AND COLOURS£5.99
- FIRST LETTERS£5.99
- TELLING THE TIME£5.99

0908 379550

**BUY ANY THREE £5.99
GAMES FOR ONLY £15.00 !!**

SOME GAMES MAY NOT YET BE AVAILABLE BUT
WILL BE SENT ON DAY OF RELEASE.

NAME

ADDRESS

.....

.....

POSTCODE

TELEPHONE

ITEM.....

ITEM.....

ITEM.....

ITEM.....

ALL PRICES INC VAT

TOTAL..... £

CREDIT CARD NO:
.....

CARD EXPIRY NUMBER:
.....

SIGNATURE.....

TEL: 0908 379550

**DIRECT SOFTWARE LTD,
UNIT 3, CROSS KEYS SHOPPING
MALL, ST NEOTS,
CAMBRIDGESHIRE
PE19 2AU**

DIRECT UNIT 3 • CROSS KEYS SHOPPING MALL • ST NEOTS • CAMBRIDGESHIRE • PE19 2AU

TEL: 0908 379550 (SHOP PRICES MAY VARY)

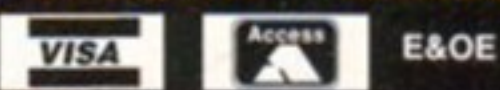

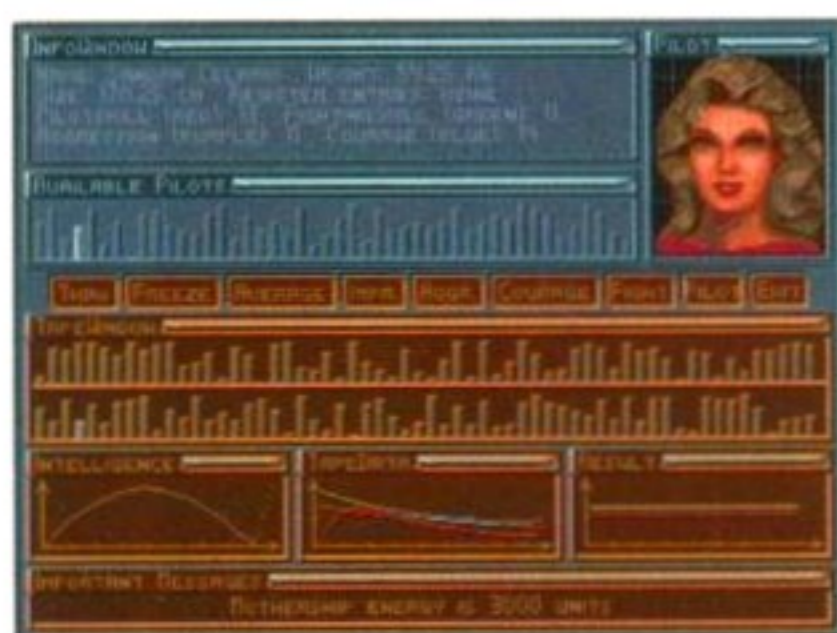

This game requires a fair amount of imagination to play. You are the controller of a giant spaceship – the Starlight (or the Starflight, as it is called in the manual), which contains the last remnants of mankind – three million frozen colonists, 46 pilots who can be popped in the microwave for instant readiness, a few raw materials and a huge, great engine to power the whole lot. Your mission is to find a new home for mankind to start again. With this motley collection, you have to build fighters and weapons to protect the Starlight, select who flies which fighter, and maintain the spaceship in good working order.

It's a much better idea to fight the bad guys at a distance rather than at close quarters and risk them damaging the mothership, because repairs consume lots of raw material and energy. If you run too low on either of these, the game automatically self-destructs and you have to start at the beginning again.

Collecting raw materials is a good idea, but it can be a better plan to create them in the Starlight laboratory, where you can discover new compounds. Mixing these is simple in theory, but beware that you can blow up your lab if you create a particularly explosive cocktail of components – uranium and plutonium should be left in the test tubes.

Industrial war

Producing new machines creates less obvious problems. You start off with three designs of fighter, blue, black and red. But actually getting them involves more than clicking on the relevant icon because you must have all the correct components first, which means you have to make the components before you can even think about working on your fighters.

At the start of the game, you can only build one unarmed fighter, and it takes time before you can upgrade to one that's armed.



Repairing your rather complicated engine is far from simple. Makes you wonder if the RAC has an intergalactic section.

Thawing out pilots is not just a case of setting the time and then hitting defrost – you have to balance the abilities of each pilot until you end up with a fully-rounded individual.



This is the main control panel. All alien encounters are dealt with through this screen – caution is advised.



Exodus 3010



Making the machines is easy enough if you have the all the right raw materials.

You can send the unarmed fighter asteroid mining, and when it comes back, you can build more. There's a fine line between getting what you need and trying to achieve the impossible – crossing that line means you've lost.

But what makes the game more than a management simulation are the encounters. Every so often, you come across an alien ship, planet or depot. You don't have to attack on sight – talking first is a good idea, but combat is inevitable with some of them.

The 3D space combat is truly terrible. The fighters go left and right easily enough, but pitching up and down is particularly slow and jerky. This element of the game doesn't work too well, but even if it did it wouldn't add a great deal to the gameplay.

Thumbs down

Well, that's it as far as the game goes, now on to the real gripes. The game comes on two disks, and insists on swapping between the flying sections and the main control menus. OK, you get used to it eventually, but that's no con-

solation if you have splashed out on a second drive. If you have 1.5Mb of extra memory, then disk swapping should be eliminated, but it wasn't on the A500 or A2000 that I tried it on. That's the trouble with Demonware games – they don't always work consistently on different Amigas.

The very worst thing about this game is the manual. For this sort of point and click game, you do need a decent manual. *Supremacy*, which was a similar game, had a brilliant manual, full of useful tutorials. What you get with *Exodus* is an incredibly thin, wibbly volume, which gives you a rough idea of what you have to do, but leaves incredible gaps as to how you actually do it. A couple of illustrations would be helpful.

I wouldn't pay £29.99 for such a poorly packaged (four sheets of A4, and a naff colour poster) and badly put together game, when there are better point-and-click strategy games, and even better 3D space games.

Pat McDonald

Exodus 3010 DMI/Demonware ■ £29.99

- Frustratingly difficult to start with.
- Sub-standard 3D graphics – not just bad, but the absolute pits.
- Excellent icons and still screens, which make the game easy when you know how.
- Engrossing if and when you get going.
- Swapping the disks will drive you mad.
- A good game, if you're a masochist.



62%

**ALL PRICES INCL. VAT
AND DELIVERY**

**TEL:
0446
421316**



**7-8 SULLY VIEW
Ty Verlon Industrial Estate
Barry CF6 3BE**

**FAX:
0446
420404**

FLOPPY DISKS

BRANDED DISKETTES

	10 DISKS	20 DISKS	50 DISKS
MITSUBISHI - DATALIFE - BRAND			
MD2D 5.25" DSDD 48TPI	£0.42	£0.41	£0.40
MD2DD 5.25" DSDD 96TPI	£0.69	£0.68	£0.65
MD2HD 5.25" DSHD 96 TPI 1.6Mb	£0.63	£0.62	£0.60
MF2DD 3.5" DSDD 1Mb	£0.52	£0.51	£0.50
MF2HD 3.5" DSHD 2Mb	£1.06	£0.99	£0.95
MF2ED 3.5" DSED 4Mb (2.8Mb)	£5.76	£5.29	£4.99
MAXELL CF2 3" DISKETTES			
MAXELL CF2 3 DISKS	£1.65	£1.60	£1.55
DATALIFE PLUS DISKETTES			
MD2D 5.25" DSDD 48TPI	£0.46	£0.45	£0.43
MD2HD 5.25" DSHD 96TPI 1.6MB	£0.73	£0.72	£0.68
MF2DD 3.5" DSDD 1Mb	£0.67	£0.66	£0.63
MF2HD 3.5" DSHD 2Mb	£1.20	£1.16	£1.14

BULK DISKETTES

We only source bulk diskettes from major manufacturers, therefore we only supply quality performance products.

100% ERROR FREE (Prices include VAT)

Price per disk	20	50	100	200	500	1000
5.25" DSDD 48tpi	0.28	0.27	0.24	0.23	0.22	0.20
5.25" DSQD 96tpi	0.30	0.29	0.27	0.26	0.25	0.25
5.25" DSHD 1.6Mb	0.40	0.39	0.36	0.35	0.34	0.33
3.5" DSDD 1Mb	0.45	0.43	0.41	0.39	0.38	0.34
3.5" DSDD 2Mb	0.68	0.65	0.63	0.61	0.59	0.58

MICE & SCANNERS

Fancy mouse festival



Bring colours into the office! SICOS offers you colourful mice with attractive designs for all common systems.

SPECIAL LAUNCH PRICE £29.95

MICE

Fancy Mouse	£29.95
Rocmouse	£12.95
Sicos Cordless Mouse	£59.95
Optical Mouse	£28.95
Trackball	£29.95
Automatic Mouse & Joystick	
Switcher	£17.95
Mouse Pad Station Great Value	£19.95
Mouse Pockets	£1.95
Mouse Mats	£2.45

SCANNERS

Sharp JX100 Colour Flatbed	
A6 paper size	£549.95
Mono hand held scanner	£98.95
Colour hand held scanner	£239.95

PRINTERS

	Price incl. VAT	Pin	Sheetfeeder	Printer
Star LC20	£77.00	9		£133.00
Star LC200 colour	£77.00	9		£199.95
Star LC15	£175.00	9		£240.00
Star LC24-200	£77.00	24		£225.00
Star LC24-200	£77.00	24		£270.00
Hewlett Packard Deskjet 500				£350.00
Hewlett Packard Deskjet 500 colour				£525.00
Hewlett Packard Paintjet				£595.00
Canon BJ10EX	£65.00			£235.00
Canon 300	£159.00			£415.00
Canon BJ330	£159.00			£470.00
Canon BJC800 colour	£205.00			£1659.00
Brother 1389	£9			£184.00
Brother HR-20 Daisy Wheel				£99.95
Panasonic KXP 1124	£24			£225.00

PRINTER RIBBONS FULLY GUARANTEED

2741 Amstrad PCW			
8256/8512/LQ3500/9256	FN		£4.95
	MS		£3.95
2482 Amstrad PC 2/3/3250	FN		£3.95
2426 Amstrad PC 4000/1512/1640			£4.65
2746 Amstrad 9512	MS		£3.95
	FN		£4.65
	FN		£5.60
2886 Amstrad LQ5000			
2412 Brother M1818/18241309/1324	FN		£3.95
2863 Commodore MPS 1500/1550			£5.60
2488 Citizen 120D Plus/180E/Swift 9			£3.65
2939 Citizen Swift 9x 24/124D/22x			£3.65
2975C Citizen Swift 9x/24x Colour			£19.50
2877 Epson EX800/1000	FN		£4.50
2273 Epson FX/MX/RX80/85LX800/450			£3.95
2478 Epson L01000/1170/1050	FN		£4.50
2477 Epson	FN		£4.50
LQ800/850/500/400/200/870/2000			
2311 Facit 4512/14/2301	FN		£3.95
2235 Mannesman Tally MT400/240/440			
2455 Oki Microline 182/192/193/320/1			
2904 Panasonic KP-P1124 (145)			£3.95
2861 Star LC10/LC20(LC9)	FN		£2.95
2869 Star LC10/LC20 Colour	FN		£4.50
2915 Star LC15/FR10/FR15	FN		£3.95
2868 Star LC24-10/24-15, LC24-200			£3.95
2868C Star Colour (single colour)			£6.50

ACCESSORIES

Keyboard Drawer	£14.99
14" Tilt and Swivel monitor stand	£9.50
Multifunction printer stand	£15.99
Universal printer stand	£3.50
Professional printer stand	£14.99
CPU Stand	£6.99
Copyholder - metal adjustable	£14.50
Copyholder - Swivel arm	£17.50
PC WORKSTATIONS	from £70.00
14" Anti-glare screen filter	£9.99
Mesh Screen filters	from £32.00
High Quality mineral glass screen filters 12", 14", 16", 20"	from £85.00
Keyboard wrist rest	£9.95
3.5" Cleaning Kit	£1.50
Dust Covers	from £3.50
Mouse mat blue, red or grey	£2.45
Mouse pocket	£1.95

FULL RANGE OF CLEANING PRODUCTS PLEASE ASK

DISKETTES STORAGE BOXES

3.5" 10 capacity	£0.85
3.5" 25 capacity	£3.25
3.5" 40 capacity lockable	£4.95
3.5" 50 capacity lockable	£5.50
3.5" 80 capacity lockable	£5.95
3.5" 100 capacity lockable	£6.95
5.25" 10 capacity	£0.95
5.25" 50 capacity lockable	£5.50
5.25" 100 capacity lockable	£6.95

CARTRIDGE STORAGE BOXES

Mini DC storage box Abba 5 cap	£10.95
Mini DC storage box Abba 10 cap	£15.95
4MM Dat storage Abba 5 cap	£10.95
4MM Dat storage Abba 10 cap	£15.95
STD Data Cartridge 10 cap box	£15.95
8MM Lockable storage 10 cap	£27.95

CABLES

IBM Assembler Printer Cable			
2 Metre			£5.95
3 Metre			£7.95
5 Metre			£12.95
10 Metre			£19.95
IBM Adaptor Cable (9 Plug/25 Socket)			
10022 2 Metre			£5.95
3 Metre			£5.95
Centronics Plug to Plug			
1 Metre			£6.50
2 Metre			£7.95
3 Metre			£8.95
5 Metre			£12.95
Power Cables			
2 Metre Extension Plug to Socket IEC			£6.95
2 Metre Power Cord IEC to 3 Pin Plug			£6.95

HARD DISK DRIVES

DR311C 105Mb IDE 13Ms 3.5" Half Height	£199.95
DR312C 211Mb IDE 13Ms 3.5" Half Height	£365.00
QUANTUM DRIVES	
ELS42AT 42Mb IDE	£175.00
LPS105AT 105Mb IDE	£299.95
LPS52SCSI 85Mb SCSI	£225.00

JOYSTICKS

THE 20 TOP SELLERS

Cheetah 125	£9.50
The Bug	£13.95
Professional A/F	£13.50
Competition Pro	
Ser. II Joypad	£14.95
Q.Shot Apache	£6.99
Q.Shot Python 1	£9.95
Cruiser Black	£9.95
Q.Shot IBM Warrior	£12.50
Megadrive Power Pad	£13.50
Teqniche Game I/O Card	£12.99
Teqniche PC Power Astick	£12.99
Mach One A/F	£12.99
Quickjoy Supercharger 123	£9.95
Quickshot Python 3 Mega	£9.95
Speedking A/F	£11.50
Professional Non A/F	£12.95
Q.Shot Del. Turbo 3 Python	£10.99
Game Commander Official	£22.50
Speedking Non A/F	£10.99

PERIPHERALS

Rocgen Plus	£120.00
A500 1/2Mb Upgrade	£29.95
A500+ 1Mb Upgrade	£39.95
A600 1Mb Upgrade	£44.95
1Mb Simms	£32.50
Megaboard Upgrade	£42.50
Power Supply Unit	£42.95
Philips CM8833 14"	
Colour Monitor	£215.00
Goldstar TV/14" Monitor	£185.00

AMIGA EXTERNAL HARD DRIVE

SPECIAL PURCHASE LOWER PRICES

- External hard drive for Amiga 500
- Built in Autoboosting
- On board Ram option up to 8Mb
- Beginner friendly on-line help
- A super-fast, high capacity hard drive that leaves others in its wake



Rochard RH800C 40Mb IDE	£329.00
Rochard RH800C Hard Disk Controller	£169.00
RAM upgrade per Mb	£42.50

3.5" SLIMLINE DRIVE

AMAZING VALUE £54.95

Low Profile 880k formatted capacity drive with enable/disable switch

SUPERB QUALITY



INK JET SUPPLIES

HEWLETT PACKARD		51606BRY PAINTJET INDIV. COLOURS	£25.50
51608 DESKJET 500	£15.95		
51625A DESKJET 300L	£29.95		
51626A DESKJET HIGH CAPACITY	£23.50		
92261A THINKJET HP PAPER	£9.95		
51604A THINKJET PLAIN PAPER	£9.95		
51605A PAINTJET BLACK	£26.50		
51606C PAINTJET COLOUR	£26.40		

DATA SWITCHES

MANUAL SERIAL		AUTOMATIC SERIAL	
12002 2 Way	£12.95	12022 2 Way (MS-201)	£29.95
12004 4 Way	£21.15	12024 4 Way (MS-401)	£79.95
12010 X Way	£22.95	12028 X Way (MS-801)	£99.95
MANUAL PARALLEL		AUTOMATIC PARALLEL	
12012 2 Way	£12.95	12032 2 Way (MP-201)	£29.95
120144 4 Way	£21.15	12034 4 Way (MP-401)	£79.95
12020 X Way	£22.95	12038 X Way (MP-801)	£99.95



**FAX PHONE
0446 0446
420404 421316**

**NO HIDDEN EXTRAS
CREDIT CARD
ORDERS
0446 421316**

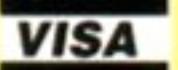

Payment by: Cheque, Postal Order, Visa or Access, Please do not send cash

directory

OPUS

NEW!!
Version 4.0

The Amiga is the most configurable, dynamic personal computer on the market today. The perfect accessory for your Amiga is **Directory Opus 4.0**- the most powerful, user-friendly, user-configurable directory utility available.

Directory Opus gives you the flexibility and freedom to effortlessly manage all your files from an interface YOU configure to suit your specific needs and taste: *NOT limiting yourself to what some programmer thinks you need or want!*

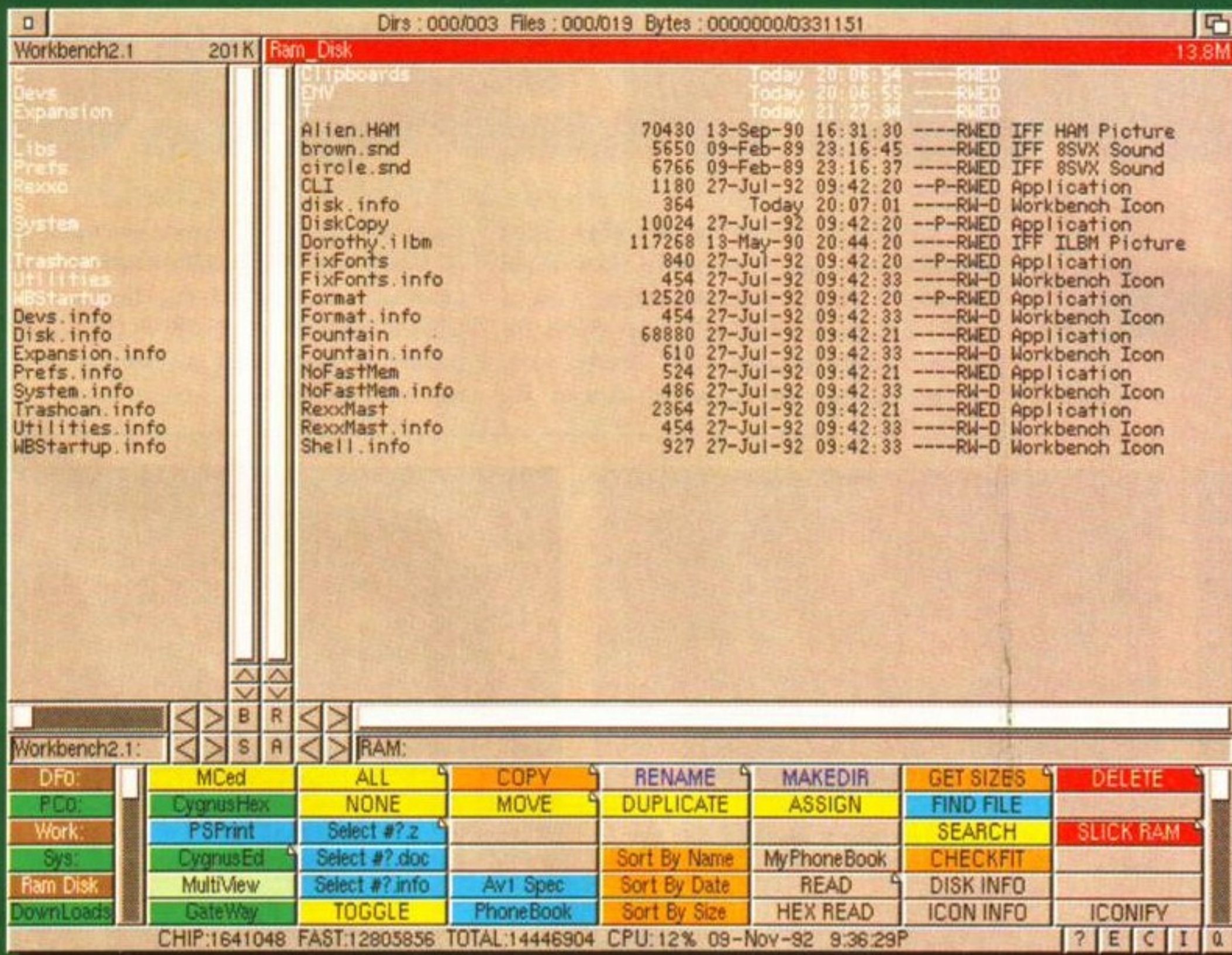

Directory Opus' Features Include:

- ✓ **Graphic Display Support:**
 - *AGA/AA (A4000/A1200)
 - *All ILBM Formats (Including SHAM)
 - *Anim and Anim Brush Playback
- ✓ **Audio Support:**
 - *Noisetracker
 - *SoundTracker
 - *ProTracker
 - *StarTracker
 - *MED w/MIDI
 - *OctaMed
 - *Oktalyzer
 - *8SVX
 - *Raw Data
- ✓ **Runs Executables**
- ✓ **Displays Fonts**
- ✓ **Displays Text Files- Normal or ANSI**
- ✓ **Displays HEX Files**
- ✓ **Unlimited User Configurable Buttons**
- ✓ **Unlimited Configurable Device Buttons**
- ✓ **Launches CanDo Decks**

And a whole lot more!!

With a completely configurable user interface, numerous built-in functions such as user definable sorts and searches, comprehensive "online" help, and full ARexx support, **Directory Opus 4.0** takes the concept of directory utilities to a new level of professionalism, power and productivity.

Pick up a copy of **Directory Opus 4.0** today, and discover why it is the **ESSENTIAL** utility for your Amiga!

Directory OPUS 4.0 is Now Available at Better Software Shops Everywhere!

United Kingdom Distributors

Checkmate Digital Ltd.
0707 664-684

Meridian Software Distribution Ltd.
081 543-3500

Micro-PACE UK, Ltd.
0753 551-888

HB Marketing Ltd.
0753 686-000

HiQ Ltd.
081 909-2092



INOVATRONICS
interactive media

Inovatronics, Inc. Suite 209B, 8499 Greenville Ave, Dallas, TX USA 75231-2499 Phone 214-340-4991 FAX 214-340-8514
Inovatronics, GmbH / Im Heidkamp 11 / W-5000 Cologne 91 / GERMANY / Phone +49-221-875126 / FAX +49-221-8704747



What an apt name for a game which is both dark and seedy. This tale of time bandits, nether-world nasties and twilight terrors could only have come from the creator of *Alien*, HR Giger...

This one's really going to get the moaning minnies and the trash-tastic tabloids talking about how 'Nintendo turned my son into a homicidal loony'. Why? Because it's the nearest thing you could have to a software nightmare, a truly weird and disturbing adventure through a crazy, vaguely nauseating world of creatures from another time. For once, the criticisms that are hurled at computer games, about them 'corrupting my five-year-old' or 'giving my nipper sleepless nights', could well turn out to be true, with CyberDream's new *DarkSeed*.

But don't be misled into thinking that this means *DarkSeed* is no good. As it happens, it is good – very good – but it's certainly not for little kids. Even a few young adults may find it all a little bit too spooky, but forewarned is forearmed, as they say.

Underneath the grisly animations of babies turning into corpses and dangly bits of viscera turning into household items, there's a rather intriguing plot to get to grips with. And it's no worse than your average 15-rated horror film, so it's really not that bad.



"My head is killing me." This is very much akin to John Hurt saying: "I've got a pain in my tummy" during that 'stomach scene' in *Alien*. And there are more links to be made here too... whoooooo!

DarkSeed

The plot is centred round a chap called Mike Dawson, who's just moved into an old house on a hill. He's gone there for a bit of peace and quiet, so there are no prizes for guessing what happens next. Pretty soon, strange things start happening around the

house and before you know it you (in the form of Mike) are dragged into a twisted tale of creatures from a parallel time. Needless to say, these creatures are not here to party, and the penalty for misguided adventuring on your part is death. And a grisly one at that.

AMIGA FORMAT

68

MARCH 1993



Now you've probably seen the morphing baby from the *MorphPlus* ads. Well now you can try the morph-



ing baby that pukes down your shirt, sucks your eyeballs out and screams at you in tongues. It's what



Virginia Bottomley might call a 'mild disorder not worthy of urgent care'. Like yeah, Virg!

GIGER MEMORIES

It would be difficult to deny HR Giger a place in the great hall of computer fame that already contains such luminaries as Douglas Adams, William Gibson and Philip K Dick.

The difference is that Giger's work, unlike that of the other 'cyberpunks', doesn't use words. Even if you don't know exactly who Giger is, you are bound to have seen at least one of his grim and quite terrifying creations.

The alien (from the now-legendary film of the same name) was of course, Giger's most famous creation, and it brought him real 'household name' status for a while. But most of Giger's work would look quite out of place in all but the most eccentric of households, thanks to his uncanny obsession with the gruesome, half-biological, half-mechanical style that has now become his eerie trademark.

Like most art, beauty is in the eye of the beholder, and with Giger's work, you either love it or hate it. Either way, it's guaranteed to provoke a

response, and *DarkSeed* is no exception. The idea for the game came from three devoted Giger fans who had the dedication needed to get in touch with the elusive Swiss artist. They approached Giger with the concept and he agreed to allow them to use his artwork. The only stipulation was that all Giger's graphics had to be digitised in high resolution (interlaced mode) to prevent jagged lines from ruining the effect.

The resulting game is undoubtedly a vehicle for Giger's incredible style, in the same way as many Hollywood films are just platforms for their biggest star. But that doesn't mean *DarkSeed* isn't successful, or that it's totally 'hollow'.

In a way, it's a classic: a real *Blade Runner* of a computer game, if such a thing exists. It's creepy, crawly, and yet it's difficult to leave alone. And it serves to blur even further, that boundary between films, science-fiction, computers and art. Welcome to the twilight zone. (*When's the programmer's cut?* – Ed.)

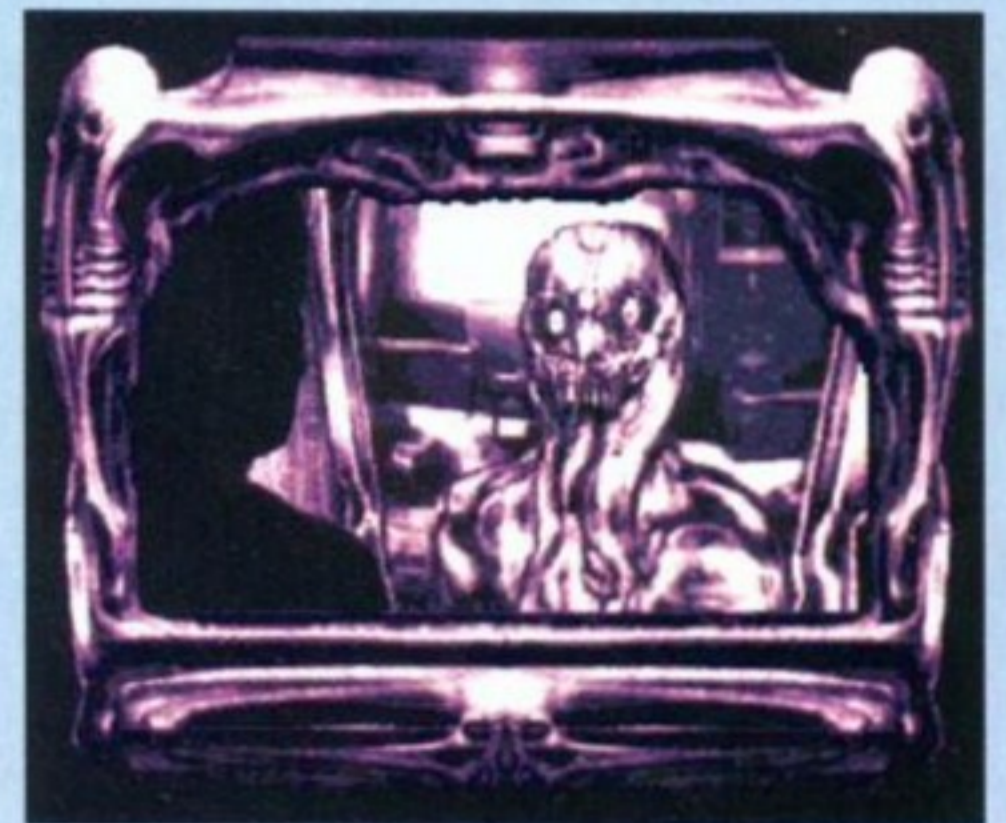

So you might think this is a Ralph Steadman creation, oh no mate. This is the famous HR Giger in full effect. He's strange, he's Swiss, his artwork takes... the field of sci-fi fantasy to new and weird areas.

CURSORY GLANCES

DarkSeed uses a quick and easy control method that takes mere seconds for you to master. Your current action is indicated by the shape that the cursor takes, and you can cycle through the different actions just by clicking the right mouse button. Here's what you can do:

HAND



Once you've discovered an item, you'll probably want to use it. Clicking on the right button a third time changes the cursor to the manipulate mode. This mode lets you pick up objects and automatically places them in your inventory at the top of the screen. Later on, you can use this mode to reuse the objects you picked up earlier.

ARROW



Wherever you click on the screen, Mike (the central character) will try to walk, in digitised, smoothly animated style. The cursor changes to four inwardly pointing arrows (and looks much like the picture here, spookily so in fact) if the object under it is a doorway. Clicking on doorways makes the program load a new location, and while this is happening, the cursor changes to an egg timer.

QUESTION MARK



By clicking on the right button once you are taken to the 'look' mode. As you move the question mark around the screen, you will find that it occasionally turns into an exclamation mark. This simply means that you've found an item which may be of use to you. Clicking on the left button gets a description of it.

THE INVENTORY



Moving the mouse up to the very top of the screen makes your inventory appear. To begin with there's nothing there, but once you've done a bit of searching, you can begin to fill it up. The items in your inventory can be moved and used with the hand icon, but sometimes their correct uses aren't immediately obvious.

THE DISK



In the corner of the inventory is the game options icon. Clicking on this takes you to a different screen that enables you to save, load and restart games. *DarkSeed* is a very big game and it can also be a very confusing and very odd game, so the chances are that you'll be using this icon a fair bit.

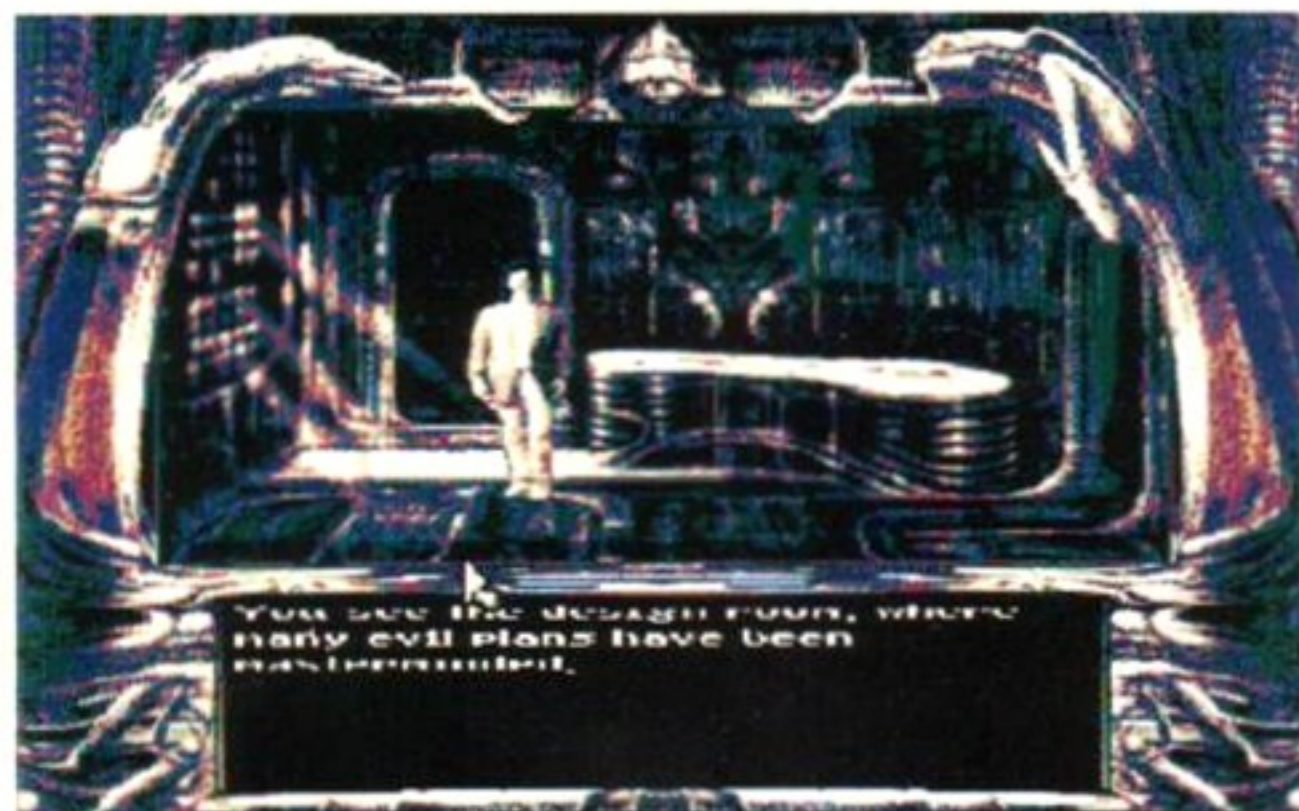

This is Mike Dawson. He's been digitised. He's had an alien foetus implanted in his brain, and an 1986 haircut, short-sides-long-back. Yeech!



This is Mike's brain indulging in a bit of one-way symbiosis with the alien foetus. As you can see, the brain has rebelled against Mike's haircut.



Doom, gloom, dark greens, strange eyeball signs hanging from the de-draped ceiling. This is the real world for Mike.

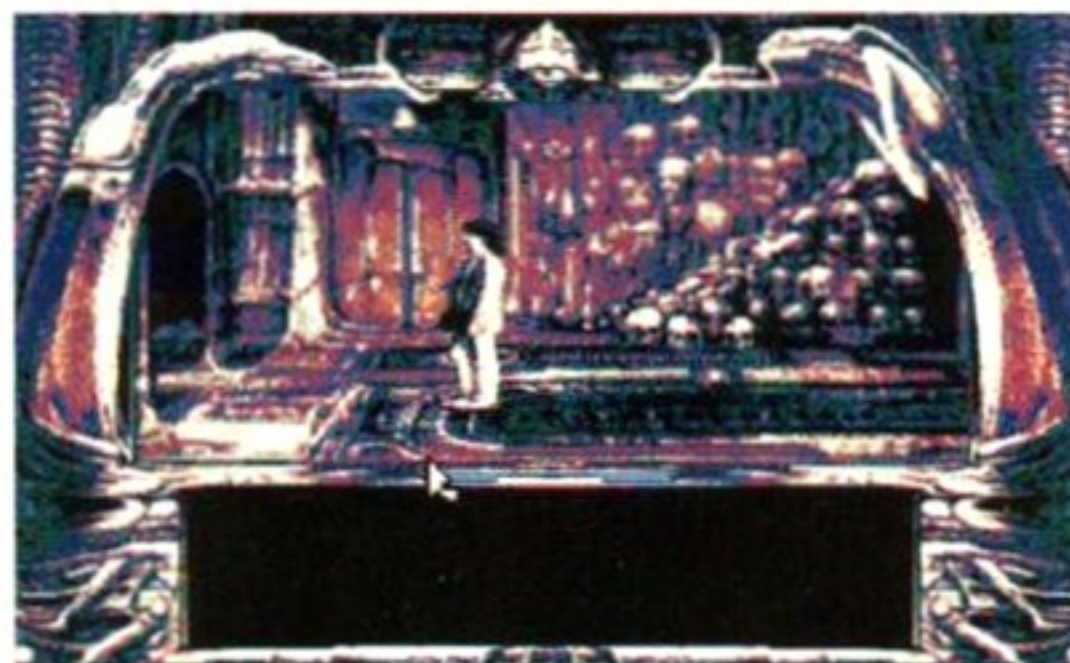

And this is the world of Giger (pronounced as Swiss gent with an airbrush and skull problem). Atmosphere ahoy!

DarkSeed will be considered by many 'normal' people as the work of a deranged mind. With HR Giger lending a large hand in the graphics department, you'd find it difficult to argue the case against this deduction. He's not exactly known for his scenic landscapes and beautiful portraits, and CyberDreams have taken the best (or worst, depending on your point of view) of Giger's work and used it to incredible effect here.

The game is filled from top to bottom with Gigerisms, as well as more normal graphics depicting the human world. The whole game has a dark, unsettling atmosphere about it.

The controls are very similar to other adventure games, like Sierra's *Leisure Suit Larry* and to some extent Lucasfilm's *Indiana Jones*. You guide your character around using a mouse-controlled pointer, and instruct him to pick up and use objects as you see fit. In this respect, *DarkSeed* is fine – intuitive, easy to control and mastered in seconds. But where *DarkSeed* falls down most is in the nature of its story telling.

The plot itself is fine – and I've already given enough of that away – the problem lies in how you discover it. Too many things in the game need to be done within a specific time, or in a certain order, and you don't necessarily

know when you've passed that 'critical point' after which you're fighting a lost cause. As a result, you often have to play the game several times over, going through scenes you've seen countless times before.

But that's *DarkSeed's* only real problem. The adventure system is fine, the controls are perfect and the graphics superb. There's even an attempt to make it more like an

interactive movie; the characters you meet talk in sampled speech, as well as in displayed text, a technique which, although not perfect, still works pretty well.

If you're one of the older, Ridley Scott generation (and if you don't know who he is, you aren't one), then you'll want to rush out and buy *DarkSeed*. My advice is 'do it'. But if you're a young under-fifteen, then you might do well to (a) keep *DarkSeed* away from your impressionable parents and (b) make sure you can handle a few sleepless nights, because it's a bit of a nightmare-maker. And don't let *The Sun* find out about this one, or we'll have a government inquiry on games before you know it.

Neil Jackson

“ The adventure system is fine, the controls perfect and the graphics superb ”

DarkSeed CyberDreams ■ £34.95

- Stunningly spooky interlace graphics, all in typical Giger style.
- A strange and involved plot, but one that's a bit difficult to follow.
- Only as strong as its weakest element – in this case, the gameplay.
- Confusing, but often enthralling. Worth it for the experience.
- Not for the faint-hearted.



72%

Orders Taken Until

DISKS...DISKS

Phone for latest prices

FULLY GUARANTEED BULK DOUBLE SIDED DOUBLE DENSITY 135tpi 100% Certified - UNBRANDED USUALLY SONY, TDK or MITSUBISHI etc GUARANTEED AND SUPPLIED WITH LABELS DO NOT CONFUSE WITH INFERIOR UNCERTIFIED. PLEASE PHONE FOR LATEST PRICES.

20 DSDD	£9.99	25 DSDD	£12.99
50 DSDD	£22.99	100 DSDD	£42.00
200 DSDD			£82.00
20 TDK Branded Disks			£19.99

DISK BOXES

Flip Top Disk Holder holds 12.....99p
Flip Top Disk Holder holds 20.....£2.99
40 Disk Holder, Lockable, Top Quality, Anti-static, with Dividers & 2 Keys.....£3.99
80 Disk Holder, Lockable, Top Quality, Anti-static, with Divider & 2 Keys.....£5.99
100 Disk Holder, Lockable, Top Quality, Anti-static, with Dividers & 2 Keys.....£6.99

DISKS & DISK BOX OFFERS

Pack of 20 in our Top Quality, Lockable 40 Disk Holder.....£13.99
Pack of 50 in our Top Quality, Lockable 80 Disk Holder.....£28.99

FILE DRAW

Drawer Type Box - Holds 200 disks, lockable, stackable, TOP QUALITY.....£10.99

POSSO BOX

Drawer Type Box - Can be stacked horizontally or vertically - Holds 150 Disks.....£16.45

DISK LABELS

Four Assorted Colours
60 for.....£1.00
200 for.....£2.00
200 Tractor Feed Labels.....£4.00

AMIGA 1500/2000 PERIPHERALS

G.V.P 42Mb Fast Access Hard Drive with 8Mb Unpopulated RAM board.....£314.99
FREE next day delivery
G.V.P 80Mb Fast Access Hard Drive with 8Mb Unpopulated RAM board.....£379.99
FREE next day delivery
G.V.P 120Mb Fast Access Hard Drive with 8Mb Unpopulated RAM board.....£509.99
FREE next day delivery
G.V.P A1500/A2000 8Mb RAM board populated with 2Mb RAM.....£159.99
2Mb SIMMS to fit the above GVP's.....£59.99 (fitted FREE if required)

AMIGA CONTROL CENTRES

These are the original and best. Manufactured by Premier Micros from Sheet Steel with welded seams and Epoxy coated to colour match the Amiga. Precision made to fit over the back of the Amiga to make a perfect platform for a monitor, improve the looks of the Amiga and provide space for a second drive etc.

A500/A500 Plus Model	£39.95
A600 Model	£34.95
Amiga 1200 Model	£39.95

DUST COVERS

Top quality Amiga Colour Dust Covers, Tailored, Monogrammed and with Bound Edges.

Protect Your Investment

Amiga 500 Keyboard	£4.99
Amiga 600 Keyboard	£4.99
Amiga 1200 Keyboard	£4.99
Citizen Swift 9/24/124D	£4.99
Commodore Monitor	£4.99
Philips Monitor MK II	£4.99
Amiga 1500 Two Part Cover	£8.99
Star LC20 Printer	£4.99
Star LC200 Printer	£4.99
Star LC24/200 Printer	£4.99
Amiga 500 with Control Centre & Monitor Combined Cover	£8.99
Amiga 600 with Control Centre & Monitor Combined Cover	£8.99
Amiga 1200 with Control Centre & Monitor, Combined Cover	£8.99

DISK DRIVES & EXPANSIONS

CUMANA CAX354 1Mb 3.5" Single disk drive - Enable/Disable switch - Thru port - Power ex Amiga.....£54.99

REPLACEMENT A500 Internal Disk Drive, fully compatible and with full instructions.....£46.99

MEMORY EXPANSIONS & SYSTEM UPGRADES 512k RAM Expansions with Clock and On/Off Switch.....£26.99

COMMODORE A501 PLUS - 1Mb module for A500 plus gives 2Mb Chip Memory.....£29.99

COMMODORE A601 - Amiga A600 1Mb Ram Expansion - gives 2Mb Chip Memory.....£29.99

AMIGA 600 - 1Mb Chip RAM Module with clock, plugs into trapdoor underneath the A600.....£44.99

SMART CARDS FOR PCMA SLOT IN AMIGA A600 and A1200

2Mb Ram Expansion Card	£114.99
4Mb Ram Expansion Card	£179.99

MICROBOTICS MBX 1200 Unpopulated 32 Bit Ram Expansion with 14Mhz 68881 Maths Co-processor. For A1200.....£149.95

1Mb SIMM for MBX 1200	£72.95
2Mb SIMM for MBX 1200	£132.95
4Mb SIMM for MBX 1200	£229.95

ZAPPO DISK DRIVE, Slim Line Design, quiet low power consumption, through port & on/off switch.....£54.99

MONITORS

PHILIPS CM8833 MK II Stereo Colour Monitor High Resolution, Free Lotus Turbo Challenge 2 Game, leads and on-site Warranty.....£229.99

Philips Tilt & Swivel Stand for the above.....£16.99

New COMMODORE 1084ST Stereo Colour High Resolution, PC Style Monitor, mounted on a Tilt and Swivel Stand. Colour matched to Amigas A600/A1200, includes leads, 12 months warranty.....£199.99

FREE NEXT WORKING DAY DELIVERY ON ALL OUR MONITORS FREE STEREO SOUND AND RGB CONNECTING CABLES.

Please note that all our Monitors are official UK specifications. We do not sell Grey imports of any kind.

AMIGA 500/600 HARD DRIVES

G.V.P. 42Mb Fast Access Hard Drive with 8Mb Unpopulated RAM board.....£334.99
FREE next day delivery
G.V.P. 80Mb Fast Access Hard Drive with 8Mb Unpopulated RAM board.....£364.99
FREE next day delivery
G.V.P. 120Mb Fast Access Hard Drive with 8Mb Unpopulated RAM board.....£454.99
FREE next day delivery
2 x 1Mb SIMMS for above (Free fitting).....£59.99

G.V.P. COMBO 40Mhz Accelerator Plus 120Mb Hard Drive Plus 8Mb RAM board all in one case.....£874.99
4Mb SIMM for above (fitted free if required).....£169.99

ZAPPO A500/A500+ Hard Drives - take up to 8Mb of 1Mb Simms, mouse operated Games Switch, SCSI through port, 12 month warranty.

ZAPPO A500/40Mb Hard Drive.....£279.99
ZAPPO A500/60Mb Hard Drive.....£329.99

2 x 1Mb Simms for above (FREE fitting).....£59.99

2.5" IDE Hard Disks for Amiga A600/A1200 Simply fits inside your Amiga, complete with lead and fixing screws

60Mb	£229.99
80Mb	£269.99

COMMODORE AMIGA SYSTEMS

COMMODORE AMIGA A600 PACKS

PACK ONE
AMIGA A600 FD BASIC PACK
New Compact Design - Kickstart/Workbench 2.05, plugs directly into any T.V. 1Mb RAM, Smart Card Slot, 3.5" Built in Disk Drive. Complete with Mouse and PSU.
12 months in home service.....£259.99

PACK TWO
EXCLUSIVE - AMIGA A600 FD with 1.5Mb RAM. As above fitted with Commodore A601 Ram Expansion (with clock) giving a total of 1.5Mb chip RAM.....£279.99

PACK THREE
AMIGA A600 - 60Mb HD PACK
AS PACK ONE PLUS a 60Mb built in hard disk drive, installed with Workbench 2.05.....£459.99

PACK FOUR
The Wild, the Weird & The Wicked. AS PACK ONE, With Deluxe Paint III. GRAND PRIX by Microprose, PUTTY by System 3, PUSHOVER by Ocean and Deluxe Paint III.....£299.99

PACK FIVE
EPIC/Language Lab, Hard Drive Pack. AS PACK ONE, with Trivial Pursuit in three different languages, Amiga Text, word processor, EPIC by Ocean, ROME by Millenium, and MYTH by System 3.....£359.99

PACK SIX
Home Office Pack
The complete all in one package for your home or business, Commodore Amiga 600 as PACK ONE with word processor, 50,000 word spell checker, database, spreadsheet with graphics, disk manager.....£299.99

COMMODORE AMIGA A1200
32 bit graphics, Kickstart/Workbench 3.0, plugs directly into any T.V. Smart Card slot, 2Mb chip RAM, 3.5" built in disk drive. Complete with Mouse and PSU.
12 Months In Home Service.....£399.99

As above with 20Mb Internal Hard Drive, Fitted under warranty by our technical department.....£549.99
60Mb Hard Drive Version.....£634.99
80Mb Hard Drive Version.....£674.99

COMMODORE AMIGA 4000
The power of the 68060 32-bit processor running at 25Mhz, new double A4 graphics chip set and 16.8 million colours. High density disk drive, High speed 120Mb IDE hard Drive. New Workbench v3.0.....£2349.99

ESSENTIAL ACCESSORIES PACK
Top quality 40 disk storage box, 10 best quality disks with labels, mouse mat, tailored monogrammed dust cover, SPECIAL PRICE £21.99 or £19.99 when purchased with any Amiga system.

ZOOL PACK
ZOOL, Pinball Dreams, Striker, Transwrite, RRP over £127 only £20.00 with any Amiga system.

PRINTER RIBBON RE-INK

Simply open your plastic ribbon case, spray over the ribbon, replace the lid and leave for 24 hours.
BETTER THAN A NEW RIBBON
Guaranteed - Restores dozens of ribbons to new for just.....£11.99

PRINTERS

FREE WITH ANY OF OUR DOT MATRIX PRINTERS: EXCLUSIVE STARTER KIT COMPRISING:

- * 200 SHEETS OF QUALITY PAPER
- * 200 SHEETS OF CONTINUOUS PAPER
- * 2 METRE AMIGA PRINTER CABLE
- * SPECIAL AMIGA DRIVERS DISK to match your Amiga perfectly to any of our printers.

FREE NEXT WORKING DAY DELIVERY ON ALL PRINTERS

COMMODORE MPS 1270A INK JET PRINTER - Swift and silent, Dual interface for both Commodore 64 and Amiga compatible, FREE Starter Kit.....£129.99

SEIKOSHA SP1900 PLUS
9 Pin dot matrix, mono, 2 high quality fonts, 192cps, 1Kb buffer, 144 x 240 dpi graphics, including FREE Starter Kit.....£139.99

SEIKOSHA SL-90
24 Pin dot matrix, mono, 2 letter quality fonts, 240cps, 20Kb buffer, 360 x 360dpi graphics, FREE Starter Kit.....£179.99

SEIKOSHA SL95
Colour, 24 pin dot matrix, 9 fonts, 43Kb buffer, 360 x 360 DPI graphics. FREE Starter Kit, 1 years on-site warranty.....£239.99

CITIZEN SWIFT 200
24 Pin dot matrix, quiet, colour, 6 letter quality fonts, 216cps, 8Kb buffer, 2 year warranty, FREE Starter Kit.....£239.99

CITIZEN SWIFT 240c
24 pin dot matrix, colour, quiet, 9 letter quality fonts, 2 scalable fonts, 240cps, 8Kb buffer, 2 year warranty, FREE Starter Kit.....£279.99

CITIZEN SWIFT 9
9 Pin dot matrix, colour, 4 letter quality fonts, 213cps, 8Kb buffer, 2 year warranty, FREE Starter Kit.....£199.99

STAR LC 20
9 Pin dot matrix, mono, 4 NLQ fonts, 180cps, 8Kb buffer, FREE Starter Kit.....£134.99

STAR LC 100
9 Pin dot matrix, colour, 4 NLQ fonts, 180cps, FREE Starter Kit.....£169.99

STAR LC 200
9 Pin dot matrix, colour, 4 NLQ fonts, 225cps, FREE Starter Kit.....£199.99

STAR LC 24/20
24 Pin dot matrix, mono, 5 letter quality fonts, 210cps, FREE Starter Kit.....£229.99

STAR LC24/100
24 Pin dot matrix, mono, letter quality fonts, FREE Starter Kit.....£269.99

STAR LC 24/200
24 Pin dot matrix, colour, 5 letter quality fonts, 222 cps, FREE Starter Kit.....£199.99

EPSON LX400
9 Pin dot matrix, mono, 3 high quality fonts, 3K buffer, 180 cps, FREE Starter Kit.....£139.99

EPSON LQ100
24 Pin dot matrix, mono, 7 letter quality fonts, 2 scalable fonts, 200 cps, 11K buffer, 50 page auto sheet feeder, FREE Starter Kit.....£229.99

INKJET PRINTERS

Citizen Pro Jet	£399.99
Canon BJ10ex	£249.99
Canon BJ300	£499.99
Olivetti JP 150	£229.99
Star Jet	£249.99

INKJET CARTRIDGES

Canon BJ10/20	£17.99
Canon BJ300/330	£18.99
Commodore MPS1270	£14.99

REFILL INKJET CARTRIDGES - TWIN PACKS

Canon BJ10/20	£17.99
Canon BJ300/330	£18.99
Hewlett Packard/Pro Jet	£16.99

GOLDEN IMAGE NAKSHA ABACUS SEGA DIGITA PANASONIC JVC MITSUBISHI EPSON CANON TOSHIBA HEWLETT PACKARD GOLDSTAR ZYDEC

12.00 Midnight

AMIGA BOOK SPECIALS

68000 Assembly Language Prog	£21.95
Amiga 3D Graphics Programming in BASIC	£16.95
Amiga Applications	£16.95
Amiga Assembly Language Program	£12.95
Amiga Basic A Dabhand Guide	£15.95
Amiga Basic Inside and Out	£18.95
Amiga C For Beginners	£17.95
Amiga Companion	£16.95
Amiga Desktop Video Power*	£24.95
Amiga Desktop Video Guide	£16.95
Amiga Desktop Video Workbook*	£29.95
Amiga Desktop Video Vol 2	£18.95
Amiga DOS A Dabhand Guide	£14.95
Amiga DOS Inside & Out Revised Edition with disk*	£23.95
Amiga DOS Manual - 3rd Edition	£18.95
Amiga DOS Reference Guide - 3rd Edition	£17.95
Amiga DOS Quick Reference	£8.95
Amiga DOS 2 Companion	£22.95
Amiga For Beginners	£12.95
Amiga Intern	£32.95
Amiga Graphics Inside & Out	£29.95
Amiga Game Makers Manual	£16.95
Amiga Hardware Reference Manual 3rd Edition	£25.95
Amiga Machine Language	£14.95
Amiga Printers Inside & Out	£29.95
Amiga Programmers Guide	£16.95
Amiga Programmers Handbook Vol 2	£22.95
Amiga ROM Kernel Ref Manual 3rd Edition Includes and Autodocs	£34.95
Amiga ROM Kernel Ref Manual 3rd Edition Devices	£32.95
Amiga ROM Kernel Ref Manual 3rd Edition Libs	£31.95
Becoming an Amiga Artist	£16.95
The Best Amiga Tricks & Tips*	£24.95
C: A Dabhand Guide	£14.95
The Commercial Games Prog Guide	£11.95
Computer Viruses & Data Protect	£16.95
Desktop Video Production	£13.95
Elementary Amiga BASIC	£14.95
First Book of the Amiga	£16.95
Get The Most Out of Your Amiga Vol 2	£9.95
Get The Most Out of Your Amiga Vol 2*	£13.95
GFA Basic Interpreter with Disk	£19.99
Inside The Amiga with C	£19.95
Inside Amiga Graphics	£16.95
Kids and The Amiga - 2nd Edition	£14.95
Learning to Fly with Flight Sim	£12.95
Making Music on the Amiga*	£29.95
Mapping the Amiga	£19.95
Mastering Amiga Amos	£19.95
Mastering Amiga Assembler	£24.95
Mastering Amiga Beginners	£19.95
Mastering Amiga DOS 2 - Vol 1	£21.95
Mastering Amiga DOS 2 - Vol 2	£17.95
Mastering Amiga Printers	£19.95
Mastering Amiga System	£29.95
Mastering Amiga Workbench 2	£19.95
MC68000 Programmers Reference Man.	£8.95
More Amiga Tricks and Tips	£18.45
Programming the 68000	£22.95
Screen Play 2	£9.95
Second Book of the Amiga	£16.95
Using Deluxe Paint - Second Edition	£18.95
Using AREXX on the Amiga Plus*	£29.95

You are welcome to visit our NEW 4000sq ft Super Store in Kettering, or visit our extensively stocked Stamford Shop.

MIRACLE PIANO TEACHING SYSTEM

Professional Midi Compatible 49 key keyboard with unique Piano Teaching System. Record, Overlay and mix your own creations with the Miracle's 8 Track Studio. With 250 lesson software, cables, earphones, footpedal and manuals. **PLAY THE PIANO IN 3 WEEKS**
Complete System£289.00

SERIOUS SOFTWARE

Wordworth version 2.0 from Digita	£74.99
Scala 500	£89.99
Scala (Needs 1.5Mb Ram & Hard Drive)	£159.99
Pen Pal	£39.99
GB Route Plus	£59.95
Design Works	£57.99
Quarterback	£46.99
Quarterback Tools	£59.99
Home Accounts	£19.99
Home Accounts 2	£36.99
X-Backup Pro	£35.99
Amos	£32.49
Amos Compiler	£19.49
Amos 3D	£21.49
Easy AMOS	£25.99
Amos Professional	£55.99
Pagestream 2.2	£139.99
NEW Final Copy II	£89.99
Art Department Professional	£179.99
Introcad	£49.99
Professional Calc	£129.99
Professional Page v3.0	£109.99
NEW Mini Office Wordprocessor, 50,000 Word Spell Checker, Database, Spreadsheet, Disk Manager & Graphics	RRP.....£59.99
Special Offer	£47.99
Junior Typist	£12.99
Gold Disk OFFICE v2	£44.99
Deluxe Paint IV aa	£89.99
Publishers Choice	£32.49
Page Setter 3	£49.99
Personal Wright	£29.99

EDUCATIONAL SOFTWARE

Fun School 2 - Under 6's	£7.99
Fun School 2 - 6 to 8's	£7.99
Fun School 2 - Over 8's	£7.99
Fun School 2 - 8 and Over	£12.45
Fun School 3 - Under 5	£15.45
Fun School 3 - 5-7 Years	£15.45
Fun School 3 - 7 and Over	£15.45
Fun School 4 - Under 5	£16.45
Fun School 4 - 5-7 Years	£16.45
Fun School 4 - 7 and Over	£16.45
ADI Maths 11/12	£19.99
ADI Maths 12/13	£19.99
ADI English 11/12	£19.99
ADI English 12/13	£19.99
ADI French 11/12	£19.99
ADI French 12/13	£19.99
ADI Junior Reading 4/5	£19.99
ADI Junior Reading 6/7	£19.99
ADI Junior Counting 4/5	£19.99
ADI Junior Counting 6/7	£19.99
Paint 'N' Create 5 years+	£22.99
Merlin's Maths 7 - 11 years	£22.99
Spelling Fair 7 - 13 years	£22.99

KOSMOS

Answer Back Junior	£14.45
Answer Back Senior	£14.45
Fact File 500 - 20th Cent. History	£7.95
Fact File 500 - General Science	£7.95
Fact File 500 - Know England	£7.95
Fact File 500 - English Word	£7.95
Fact File 500 - Natural History	£7.95
Fact File 500 - World Geography	£7.95
Fact File 500 - First Aid	£7.95
Fact File - Spelling	£7.95
Fact File - Sport	£7.95
Fact File - Arithmetic	£7.95
Fact File - Association Football	£7.95
The French Mistress	£14.45
The Italian Tutor	£14.45
The German Master	£14.45
The Spanish Tutor	£14.45
Maths Adventure	£19.99

L.C.L

Micro English (GCSE)	£18.95
Micro French (GCSE)	£18.95
Micro Maths (GCSE)	£18.95
Micro German (GCSE)	£18.95
Mega Maths (A Level)	£18.95
Primary Maths (3-12)	£18.95
Reading and Writing (3-8)	£17.95

MISC

Better Spelling (8-Adult)	£16.99
Junior Typist	£12.99
Better Maths	£16.99
Noddy's Playtime	£19.99

NEW DELUXE PAINT III TUTOR VIDEO

Learn to get the best from NEW Deluxe Paint III. This video shows you how to design and execute your own Animations, Titles and so much more in a Step-By-Step, Easy-To-Follow way.

Subjects covered include:

- ★ Screen Painting
- ★ Zoom
- ★ Colours
- ★ Working with Text and Fonts
- ★ Stencils
- ★ Perspective
- ★ Animation
- ★ Video Titling etc, etc



RUNNING TIME: NEARLY THREE HOURS!!

Superb Value At ONLY £18.99 inc Post & Packing

"I was a little sceptical about the chances of taking a complete beginner to such artistic heights but I must admit to being wrong"
AMIGA COMPUTING, September 1991

ACCESSORIES

Mouse Mat - top quality	£2.99	Alfa Data Track Ball	£29.99
Mouse Bracket - mouse storer	£1.99	Voltmace Delta 3A Analogue Joystick	£12.99
Mouse Mat & Mouse Bracket - gift pack	£4.99	Speed King Hand Held Analogue Joystick	£14.99
3 Metre Joystick or mouse extension lead	£5.99	Analogue Adapter - allows use of IBM-PC	
Twin Joystick/mouse 6" extension lead	£5.99	Analogue joystick on an Amiga	£5.99
Joystick & Mouse "Y" lead - plug both your joystick and mouse in the mouse port	£5.99	Sigma Ray Pistol Grip/Microswitched / Auto Fire	£13.49
Joystick & Mouse auto sensing switch box by Robo	£16.99	Zip Stick Autofire Joystick	£12.66
Aerial Switch Box - plugs on to TV aerial socket. Allows you to switch the TV input from aerial to computer	£3.99	Quickjoy Foot Pedal	£24.95
Modulator Extension Lead - Stops your modulator falling out! 12" lead plugs between Amiga & modulator allowing modulator to sit along the back of Amiga	£10.99	Desk Top Copy Holder - Makes inputting of data easier supporting paper next to monitor	£9.99
3 Metre Amiga to Stereo Lead	£4.99	Space Saver Copy Holder - Moving arm clamps to edge of desk supporting paper next to monitor	£17.99
3.5" disk drive head cleaning kit	£1.99	Monitor Arm - Moving arm clamps to edge of desk supporting monitor above the desk, creating valuable space	£34.99
Naksha mouse with FREE mouse mat, bracket and Operation Stealth Game	£25.99	Printer Stand - 2 piece fits any printer	£7.99
Tecno Plus Mouse - 300 DPI, Microswitched	£17.99	Power Scanner with V3 software	£109.99
Happy Mouse with FREE mouse mat	£17.99	Surge Protection Plus	£11.99
		GVP DSS8 - Digital Sound Studio, Sound Sampler	£39.99
		E.M.U.S - Midi Interface and Sampler in one	£89.99
		Midi Connector - with leads	£29.99



DEPT AF, 3 STATION ROAD, KETTERING, NORTHANTS NN15 7HH. SHOP HOURS (0536) 414892 OUT OF HOURS (0780) 720531

- TELEPHONE DIRECT TO OUR MAIL ORDER HOTLINE. ALL MAJOR CREDIT CARDS ACCEPTED. QUOTE YOUR NUMBER AND EXPIRY DATE. SAME DAY DESPATCH.
- SEND ALL FORMS OF PAYMENT MADE PAYABLE TO AUDITION COMPUTERS LTD. WITH YOUR ORDER PLEASE SEND YOUR NAME, ADDRESS AND DAYTIME TELEPHONE NUMBER ALONG WITH YOUR DETAILED ORDER REQUIREMENTS. GOODS WILL BE SENT BY POST, FREE OF CHARGE IMMEDIATELY AFTER CHEQUE CLEARANCE.
- ALL OUR PRICES INCLUDE FREE STANDARD DELIVERY ON ALL ORDERS OVER £15.00. ORDERS UNDER £15.00 MUST INCLUDE £2.00 SMALL ORDER CHARGE. NEXT WORKING DAY DELIVERY ONLY £2.50 EXTRA ON ALL ORDERS OVER £100.00.

MINIMUM ORDER £15.00 else surcharge £2.00

GOLDEN IMAGE NAKSHA ABACUS SEGA DIGITA PANASONIC JVC MITSUBISHI EPSON CANON TOSHIBA HEWLETT PACKARD GOLDSTAR ZYDEC



There's a twist to the Iceland level. Instead of collecting gems, you enter a 3D-scrolling, shoot-em-up sub-game with Gouraud shading. No sorry, I'm lying, actually you jump around and collect gems, just for a change.

Tearaway Thomas

All Amiga programmers want to write a *Sonic* beater at the moment. Gremlin managed it with *Zool*, and now Global Software have gone for a rather shameless attempt at emulating the hedgehog in blue with *Tearaway Thomas*; an unspecified creature from outer space. To be frank, Thomas wants to be Sonic. He's probably gone to Sonic classes. You can imagine him as a kid: "Mum! Mum! Can I be Sonic? Please can I?" "No! Go away and jump about a bit, you little... er... whatever you are. And stop using that blue paint, you'll poison yourself."

I wanna be a youth icon

But let's be optimistic. Let's approach the game with an open mind. First, the plot: hmmm... ho ho ho, very slightly amusing, full of anagrams of Mario, Sonic and other Sega-related icons. Unfortunately it never points out just what Thomas is, aside from a tearaway.

Right, straight to the action. Fifty worlds, yes... collect some gems and find the exit. Hit the nasties on the head for extra points. Does it kill them? Er, no, apparently not.

So, world one, Woodland. Set in a wood, appropriately, so there are lots of bears and birds. The first thing to hit you is the speed of the scrolling - it's pretty nifty. Coupled with the simple controls (left, right and a twirling

Sonicy jump), it's gratifyingly easy to scream about collecting gems. But to gain speed the programmers have sacrificed panoramic backdrops and twee scenery usually associated with such games - on the first level there's just the odd cloud, lots of trees and a bit of parallax.

It's only when you've completed levels one to four that the truth of the game sets in. This is it. There is no more to it: run, jump to get the gems, avoid the nasties (jumping on their heads is risky, because if they hit you, you lose two seconds from your time limit), then find the exit. True, later on Thomas gets to grips with ropes, trampolines and hidden



Ghostland, full of well... ghosts. At least the programmers have an excuse when the ghosts flicker wildly - it's scary, innit?

Thomas distracts the bear-shaped nasty with his hovering gag, while his cohorts bring the Bedford van round the back and surreptitiously clean out the level of gems. Works every time.

bonus screens, but these are just diversions. Even in the four other worlds (Toyland, Ghostland, Iceland and Futureworld) your objectives and methods remain the same, it's only the scenery that changes.

He's no Zool

It's obvious from the packaging that Global are a low-budget outfit, but they've tried hard to come up with a creditable *Sonic* alternative for the Amiga. It hasn't come off, because a) *Zool*'s so much better, b) on a standard A500 it's just not fast enough and c) the game's a bit dull. For instance, there are no continues. To complete the game, you would need to play all 50 levels right through with just three lives. Not even the most rabid *Sonic*ophile would have the time or inclination for such a gargantuan task, let alone Mr Average Punter Who Wants To Play *Sonic* On His Amiga.

The dreaded words 'Look out for *Tearaway Thomas 2*, coming soon!' on the packaging means Global's ambitions to see Thomas on T-shirts up and down the land aren't over yet. Which is a pity, because if they turned their hands to more original ideas, games that the Mega Drive couldn't support in a million years, they'd be on to a winner.

Ed Ricketts



Tearaway Thomas Global Software ■ £19.99

- Very fast, possibly the fastest scrolling Amiga game yet, but a bit bare.
- Gameplay rapidly becomes very repetitive. If you've collected one gem you've collected them all. At least it's cheap.
- Fifty worlds across five levels add a bit of variety, but...
- ...a lack of continues and lives means it's almost impossible to finish.
- Occasionally looks like a PD game.

Verdict **64%**

TAKIN' FLIGHT SIMS BY STORM

'There are
two sides
to every
campaign'

Exclusive Report from
PSYGNOSIS

IN THE MODERN combat theatre, a war cannot be won without both land and air attack working in unity.

That's why Combat Air Patrol combines comprehensive air strike/intercept capability plus an integrated land attack scenario, linked to your fighter pilot kill ration.

Not only that, the playability of CAP is gonna make it a legend among flight simulators - just as the exploits of pilots and generals in the Gulf War made them legend.

If you're looking for a thoroughbred flight simulator and full action Gulf War strategy game, then you've got CAP in your sights!

The package includes fully illustrated Gulf War diary.



AVAILABLE: Soon on the Amiga

from PSYGNOSIS LTD SOUTH HARRINGTON BUILDING SEFTON STREET LIVERPOOL L3 4BQ 051-709 5755

WeServe of Hampshire Established 7 years

High quality products. Full technical support.

High quality products. Full technical support.

Amiga Workstation /Expansion System
Monitor stand with shelf for drives etc. Strong metal construction made from 14SWG steel epoxy coated. No Cables or mouse are included.
Special price £27.50

New Citizens

Swift 240
24pin Colour*

Advanced 24pin printer, (Swift 24E replacement). Phone for a data sheet *optional colour. Price with cable & paper

240 Mono £245
240C Colour £265

Swift 200
24pin Colour*

Enhanced 24pin printer, (Swift 224 replacement). Phone for a data sheet *optional colour. Price with cable & paper

200 Mono £195
200C Colour £219

Citizen's Print Manager

These advanced printer drivers transform colour printouts to laser type quality
Version 1 (224 & 24E) £5
Version 2 (Swift series 2) £10
Drivers 1/2 price if bought with a printer

Printer Drivers

Canon BJ-10e/ex £5
Deskjet 500 Colour £10

Citizen 120D +
with cable & paper £109

All Citizen printers have 2 year warranty

Citizen Swift 9
with cable Mono £155 & paper
with cable Colour £179

Panasonic KXP1123

Probably the best 24pin mono printer available. With cable & paper
£169

Panasonic/Epson

KXP1170 9pin 134
KXP1124i 24pin 215
KXP2180 9pin Colour 189
KXP2123 24pin Colour... 229
Epson LX400 9pin 119
Epson LQ570 24pin 265
Prices include VAT cable & paper

Naksha Scanner

New with touch up software £109

Naksha Mouse

for Atari ST & Amiga with house & mat £21.50

Squik Mouse

for Atari ST & Amiga £13.90

Deskjet 500

HP 300dpi Inkjet printer. Laser quality at dot matrix price. 3 year warranty. With cable & paper £325

Deskjet Colour

300dpi colour inkjet printer. Colour laser quality at 1/10 of the cost. 3 year warranty. With cable & paper £419

New HP Deskjet 550C

300dpi colour inkjet printer. Colour laser quality, with colour and black cartridges resident. 3 year warranty. With cable & paper £529

Printer Packs

All printers are supplied with a printer pack consisting of printer paper and a connection cable.

Free of charge

A stand is £5.00 extra (with a printer)

Type Through Protective Covers
for

A500 A500+ A600 & A1200 (Please state model) £17.50

Printer Dust Covers

most types in stock from £4.70

Canon BJ-10ex
360dpi Inkjet printer with cable & paper £199

Star SJ-48

360dpi Inkjet printer with cable & paper £199

Star LC100

9pin colour with cable & paper **New** £159

Star

LC20 Mono 9pin 119
LC200 Colour 9pin 175
LC2420 Mono 24pin 185
LC24100 Mono 24pin 175
LC24200 Colour 24pin .. 249
Prices include VAT cable & paper

Kickstart Upgrades

Commodore 2.04 full upgrade 79.00
Kickstart ROM only v2.04 41.50
Kickstart ROM only v1.3 29.00
Phoenix rom sharer 24.95
Keyb'd operated rom sharer 24.95
VXL30 25MHz Accelerator ..239.00
Fatter Angus custom chip 37.50

True Mouse

for Atari ST & Amiga £15.90

Happy Mouse

for Atari ST & Amiga £14.90

New Prices

GVP Series 2

for A500 Hard Disks

40Mb Hard Disk £319
80Mb Hard Disk £369
120Mb Hard Disk £419
80Mb A530 Combo £649
120Mb A530 Combo £749

for A1500

40Mb Hard Disk £299
80Mb Hard Disk £329
120Mb Hard Disk £399
Controller (no disk) £134

Ram Upgrades

A500 1Mram + clock £24.90
A500 1Mram no clock £19.90
A500+ 1Mram +clock £39.90
A600 1Mram + clock £49.90

Citizen ProCM

14" Super High res. Multisync Colour monitor, dot pitch 0.26mm, suitable for A3000 or A4000 with cable £349

Philips CM8833 MK2

Rebadged as AKF17
14" Stereo Colour Monitor. Dot pitch 0.42mm. Medium Res. £165 without cable £169 with cable

Commodore 1084SD

14" Stereo Colour Monitor. Dot pitch 0.42mm. Medium Res. £179 with cable £175 without cable
Price valid for current stock only

Philips CM8833 MK2

UK. 240V £219 with cable + game £215 without cable
If game not required reduce above prices by £5.00
Price valid for current stock only

Accessories

3M Joystick/Mouse lead 3.75
A500 Printer cable 7.95
Modulator/Disk Extension 10.95
23way Plug or socket 2.95
A500 Dust Cover 4.70
Mouse Mat (thick soft type) .. 4.95
Mouse House 2.95
1M internal 3.5" drive 49.00
A500 replacement PSU 39.00
A590 replacement PSU 49.00
Rocgen Plus - Genlock + .. 129.00
Disc Wallet for 32 disks 7.95

Tech. Support 647400

Phone for our 70 page catalogue. All prices include 17.5% VAT
EDUCATIONAL AND GOVERNMENT ORDERS WELCOME
All products have a 30 day money back & 12 month warranty. Prices are subject to variation without prior notification. Please phone for express clearance of cheques.
Established 7 years. 3 minutes from M27 Junction 11. Free parking. Open 9 to 5.30 Monday to Friday & 9 to 5 Saturday Postage 94p or £3.53 Securicor £6.46 (£5.50 + VAT)

WeServe



Larger items delivered by Securicor

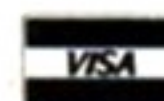

Floppy Drives

Cumana CAX354
£49.90 1M external While stocks last

Commodore

A1011 1M external £48 While stocks last

Roctec/Zappo

New All Amigas A500-A1200 1M external drive £49.90

Amiga A1200

5x faster. Workbench v3. 2M ram. Custom graphics - 256K colours from 16.7 million. £359

Amiga A4000

25MHz 6Mram Wb 3 120Mb Hd £2099

Amiga A600

Standard A600 single floppy £265 with game £259 without software

Amiga 600SD

(D.Paint III, Grand Prix, Putty, Pushover) **Wild Weird & Wicked** £299

Amiga 600HD

(Trivial Pursuit, Epic, Rome, Pushover) **Epic Pack** £375

SONY DISKETTES

SONY branded (lifetime warranty)

(100% certified error free)
10x 3.5" DS/DD 135tpi 7.50
50x 3.5" DS/DD 135tpi 32.30
100x3.5" DS/DD 135tpi 59.93
250x3.5" DS/DD 135tpi 141.00
1kx 3.5" DS/DD 135tpi 540.50

DISKETTES

SONY / DYSAN bulk (lifetime warranty)

(100% certified error free)
10x 3.5" DS/DD 135tpi 5.95
50x 3.5" DS/DD 135tpi 21.86
100x3.5" DS/DD 135tpi 39.60
250x3.5" DS/DD 135tpi 94.88
1kx 3.5" DS/DD 135tpi 379.53
40 x 3.5" Disk box with lock..... 5.49
100 x 3.5" Disk box with lock..... 7.50
Carriage on 50+ disks £3.53

MAR 93

Visit our showrooms. See before you buy.

Visit our showrooms. See before you buy.

0705 647000 New Telephone Number 0705 647000

Amiga/Format Dept.
40-42 West Street
Portchester Hants
PO16 9UW
Tel: 0705 647000

AMIGAのプロショップだ!

A600DX SET V2.04 74,000	A500 V1.3 1MB RAM 80,000	A1200 V3.0 AGA 89,000	A1200HD V3.0 AGA 85MB 134,000
A2000 V2.05+ECS 139,000	A3000 5MB/HD120MB 294,000	A4000 68040 6MB/HD120MB 449,000	A3000T 68040 5MB/200MB 468,000

■グラフィックス

SCENERY ANIMATOR.....	14,900
DELUXE PAINT 4.1.....	21,800
DELUXE PAINT AGA.....	26,900
IMAGINE 2.....	49,600
IMAGE MASTER.....	38,000

DC-TV.....	68,000
CALIGARI 2.....	45,900
ALADDIN 4D.....	52,900
PLAYMATION.....	45,000
VISIONA 2MB/85MHZ.....	368,000
OPAL VISION.....	158,000

■エミュレーター

AMAX II PLUS.....	57,900
ROM FOR AMAX II PLUS.....	34,900
PC286 BRIDGE BOARD A500HD/A530.....	24,900
386SX BRIDGE BOARD.....	119,000

■ビデオ

IMPACT VISION 24.....	298,000
VIDEO TOASTER V2.....	324,000
PERSONAL TBC II.....	26,900
MORPH PLUS.....	29,800
VIDI-AMIGA 12.....	24,900

AVIDEO.....	139,000
DELUXE VIDEO II.....	29,800
ART DEPT PRO V2.0.....	34,800
FLICKER FREE VIDEO 2.....	39,800
AZ320 DISPLAY ENHANCER.....	39,800

■言語

AMOS PROFESSIONAL.....	14,800
SAS/C LATTICE C V6.0.....	35,500
DEV PAC 3.....	16,900

[PRICES QUOTED IN JAPANESE YEN]

■ハードディスク

GVP 5MB/5MB SCSI CONTROLLER A500.....	56,000
GVP 5MB/5MB SCSI CONTROLLER A2000.....	27,800
GVP 120MB/5MB HARD DISK A500.....	118,000
GVP 120MB/5MB HARD DISK A2000.....	98,000
GVP 200MB/5MB HARD DISK A2000.....	148,000
GVP 240MB/5MB HARD DISK A2000.....	168,000
OCTAGON 2008 SCSI II CONTROLLER.....	54,000

■アクセラレーター

ZELUS 68040 28MHz SCS II A2000.....	298,000
ZELUS 68040 33MHz SCS II A2000.....	389,000
G-FORCE 25MHz+1MB+68882.....	103,000
G-FORCE 40MHz+4MB+68882.....	188,000
G-FORCE 50MHz+4MB+68882.....	217,000
68881 MATH CO.....	16,600
68882 MATH CO.....	34,800
A530 TURBO HD 120MB/1MB 40MHz.....	184,000
VXL30 25MHz A500/A2000.....	59,000
VXL32 2MB RAM FOR VXL30.....	43,000
DERINGER 25MHz+4MB+MATH-CO A500.....	89,000
68040 28MHz FOR A500.....	198,000
68040 33MHz FOR A500.....	249,000
BLIZZARD TURBO 16MHz A500/A2000.....	39,800
ADSPED 14MHz A500.....	32,900

■音楽

AUDITION 4.....	15,800
THE MIRACLE.....	89,000
BARS & PIPES.....	41,900
ONE-STOP MUSIC SHOP.....	129,000

■バックアップ

MARVERIC.....	9,800
LOCKPICK.....	12,900
X-COPY PRO.....	11,900
SUPER CARD AMI II.....	14,900

WE EXPORT VIDEO GAME CARTRIDGES

GAMES FOR (USED AND/OR NEW):

- FAMILY-COMPUTER
- SUPER FAMILY COMPUTER
- MEGA-DRIVE
- PC ENGINE
- NEOGEO ETC.
- ALL NTSC JAPANESE VERSION

FAX ENQUIRY WELCOME TO:

FAX NO. 03-3837-8218 (JAPAN 81)

LETTER ENQUIRY TO:

SYSTEM COMPBAC, INC.,
3RD FLOOR NAKAYA BLDG.
4-22-10 TAITO, TAITO-KU, TOKYO,
110 JAPAN.

店頭・通販 a beautiful amiga life for you 〒110 東京都台東区台東4-22-10
輸入直販 システムコンパック 中層ビル3階
木曜定休 TEL: 03-3837-8689



DATAPLEX COMPUTERS LTD.

129 Bath Road,
Slough,
Berkshire,
SL1 3UW

19 High Street,
Old Town,
Swindon, Wilts

Tel: 0753 535557

Tel: 0793 488448

Prices including VAT

SHOWROOM
open:
Mon - Fri
9.30 - 5.30
Saturday
9.30 - 4.30

MAILORDER
Consumables
add £2.50
Hardware
add £9.00
(courier)

AMIGA A1200

- * 2 Meg RAM
- * PSU, Mouse
- * Free box of 10 disks
- * Mouse Mat

£379 inc VAT

AMIGA A1200

Plus Free Games

PACKAGE AS ABOVE PLUS

- * ZOOL * Striker
- * Pinball Dreams * Trans Write (word processor + spell checker)

£399 inc VAT

AMIGA A600

Amiga A600 + Deluxe Paint III + game

£289 inc VAT

Amiga A600 + 20 Mb HD...

£455 inc VAT

AMIGA A1500

new version

A1500 Accounts Plus pack including Puzznick, Toki, Elf, Operation Systems Software, Home Accounts, Platinum Works, Deluxe Paint III + manual

£545 inc VAT

ADDITIONAL PACKS

Amiga A500 Plus Cartoon Classics
with 10 extra games£299

ACCESSORIES

512K Ram + clock.....	£35.00
1 Meg Ram + Clock.....	£115.00
A500 Power Supply Unit.....	£45.00
Naksha Mouse plus Operation Stealth.....	£29.00
1Mb Upgrade for A500 Plus.....	£49.00
14" screen filter.....	£17.00

MONITORS

Philips CM8833 MK II Colour Monitor + FREE Lead + FREE game
£210 inc VAT
with 1 year on-site maintenance

PRINTERS

Star LC20 Mono.....	£135
Star LC200 Colour (9 pin).....	£188
Star LC24-20 (24 pin).....	£194
Star LC24 200 Colour (24 pin).....	£258
Panasonic KXP11241.....	£222
Panasonic KXP 1123.....	£175
Panasonic KXP2123 (24 pin black).....	£185
Panasonic KXP2123 (24 pin colour).....	£225
Citizen 1200 +.....	£110
Citizen Swift 24E + Colour Upgrade.....	£290
Citizen Swift 9 + Colour Upgrade.....	£195
Citizen 240E.....	£299
Starjet Bubblejet Printer, SJ48.....	£229
Canon BJ10EX.....	£222
HP Deskjet 500 + Leads.....	£327
HP Deskjet 500 (colour).....	£420
HP Deskjet 550 (colour).....	£489

All above come complete with leads

AMIGA HARD DRIVES / HARD CARD (GVP SERIES II)

FOR A1500	
82Mb h/card (0-8Mb).....	£355
120Mb h/card (0-8Mb).....	£465
FOR A500	
82Mb h/drive (0-8Mb).....	£385
120Mb h/drive (0-8Mb).....	£480

Upgrade the above with 1Mb SIMM module £39

AMIGA DRIVES

1 Meg 3.5" Internal.....	£55
1 Meg 3.5" External (Roclite).....	£67



YEW TREE LEISURE

Mail Order supplies

COMPUTER AND VIDEO GAME SPECIALISTS

AMIGA PUBLIC DOMAIN 99p

AMIGA PUBLIC DOMAIN
FISH DISKS UP TO 720 99p
DEJA VU UP TO 85 £3.99
LARGE RANGE OF T-BAG 99p

Large range of PD in stock new titles arriving daily from all over the world. Tell us your interest, games Demos etc and we will fill your disk up.

PERIPHERALS ETC...

1.5 Meg Upgrade.....	£75.00
5.25 Drive.....	£70.00
3.25 1 Meg Drive.....	£49.00
Amiga Mouse.....	£30.00
Upgrade with clock.....	£32.00
Upgrade without clock.....	£24.00
Amiga Power Supply.....	£24.00
Trackball Mouse.....	£38.00
Drive Cleaners.....	£2.00
Mouse Mats.....	£2.00
Disks.....	£0.40
Labels.....	£1 ea.

Disks - phone for bulk price

GAMES UNLIMITED

Far too many titles to list, hundreds of clearance titles between £1-£5
Winter Clearance all at £5 each

- 9 Lives
- Badlands
- Cadaver
- Challenge Golf
- Days of Thunder
- Die Hard 2
- Flames of Freedom
- Golden Axe
- Hudson Hawk
- Inter Phase
- Midwinter
- Radio Control Race
- Smash TV
- Wings
- Xenon 2
- Zork 3

MANY MORE AVAILABLE INCLUDING LATEST RELEASES ETC.

GAMES MACHINES ETC....

We stock Megadrive, Master System, Nintendo etc, Machines and have a large range of games to date at very competitive prices.
Joysticks, converters, control pads carry cases etc....

Phone or write for list stating requirements.

SORRY NO PERSONAL CALLERS

Andy Townsend
84 Yew Tree Road
Attleborough,
Norfolk NR17 2RD
Phone/Fax: 0953 452803
Mobile: 0860 458958

The Punter[©]

- The UK's No.1 Football Pools program.
- Uses information from daily newspapers.
- For Littlewoods, Vernons and all coupons.
- Ideal for pools and fixed odds.
- The Punter can be used for British and the Australian pools. (Includes new 1993 pts)

The company which brought you the best horse racing software in the World, *The Tipster*, now brings you *The Punter*, our pools prediction program. Simple to use, and taking only 30 mins, this program allows you to predict all 58 matches on a coupon. Please phone for a demo disk (£9.95 refundable) which also contains *The Tipster* (Horses) and *The Dogs* (Greyhounds).



£29.95

inc VAT



Sidmouth Software

PO BOX 7, SIDMOUTH, DEVON EX10 0TD

☎ 0395 67073 (24Hrs)

THE GREATEST SHOW ON TV...

NEW! The greatest show on TV is now a magazine! **£1.75**

THE GAMES MASTER

Sega! Nintendo! Amiga! More!

Issue Two February 1993

140 PAGES!
More reviews!
More previews!
More tips!

MEGA DRIVE
Terminator 2, Rolo to the Rescue, Steel Talons

SUPER NES
Wing Commander, Gods, Mickey Mouse

AMIGA
Krusty's Super Fun House, Fate of Atlantis, Lethal Weapon

3D SPECIAL!
Prepare for the 3D TV spectacular with our incredible free poster and glasses!

20 PAGES OF TIPS:
DYNABLASTER, JOHN MADDEN 93, BEAST B, ANOTHER WORLD & MORE!

EXCLUSIVE REVIEW!
THE CHAOS ENGINE
The dawn of the Steam Punk age?

GLOBAL WARRING!
WIN £1,000
OF MODEM-LINK GAMES HARDWARE
See page 96

THE MOST PLAYABLE GAMES EVER?
MEGA DRIVE: MICRO MACHINES
AND SNES: SUPER STAR WARS

Future Publishing
The guarantee of value
CHANNEL FOUR TELEVISION

9 770967 985009

Included with issue two you'll find an immensely pleasant and very high quality 3D feature. There's a poster, complete with several 3D images, and, of course, the glasses to go with them. These glasses also tie in neatly with a forthcoming 3D feature to appear on the GamesMaster TV programme, thus cementing the already strong link between the popular show and the magazine.

It's crazy, it really is. Just look at how much has been crammed into this already over-large magazine. All the news from the entire industry, as well as the best in reviews, previews and of course numerous appearances by that self-styled wizard of the code, the GamesMaster. There's so much going on, it'll make your nose bleed.

...IS NOW ON PAPER!

Rubysoft

**PC AND SEGA GAMES
ALSO SUPPLIED
PLEASE PHONE**

When service matters.. **MOST!**

RUBY CHARTBUSTERS

	ST	AMIGA		ST	AMIGA
A TRAIN *	N/A	29.95	LOTUS TURBO CHALLENGE 2	17.95	17.95
A320 AIRBUS	24.55	24.55	LOTUS 3 THE ULTIMATE CHALLENGE	17.95	17.95
A T A C *	T B A	T B A	LURE OF THE TEMPTRESS 1MEG	19.95	19.95
AVBB HARRIER ASSAULT *	23.95	23.95	MACDONALDS LAND *	17.95	17.95
ABANDONED PLACES	19.95	19.95	MAGIC POCKETS	17.95	17.95
ABANDONED PLACES 2 *	19.95	19.95	MAGIC WORLDS	17.95	17.95
ALIEN BREED SPECIAL EDITION 92	N/A	9.95	MAUPITI ISLAND	N L A	17.95
AQUATIC GAMES (JAMES POND)	17.95	17.95	MEGAFORTRESS	N/A	20.95
ADAMS FAMILY	17.95	17.95	MEGA SPORTS	18.95	18.95
AIR BUCKS	20.95	20.95	MEGA TRAVELLER 2 1MEG	19.95	19.95
AIR SUPPORT (PSYGNOSIS)	17.95	17.95	MICROPROSE FORM 1 GRAN PRIX (THE BEST!!!)	22.95	22.95
ARCHER MACLEANS POOL	17.95	17.95	MICROPROSE GOLF	22.95	22.95
A R S E N A L *	17.95	17.95	MIGHT AND MAGIC III	N/A	22.95
ASHES OF EMPIRE	N/A	25.95	MIDWINTER 2 1MEG	N/A	22.95
ASSASSIN	N/A	17.95	MOONBASE	N/A	25.95
B C KID	17.95	17.95	MOONSTONE	N/A	20.55
BARDS TALE TRILOGY *	N/A	23.95	MONKEY ISLAND 2 1MEG	N/A	23.95
BANE OF THE COSMIC FORGE	N/A	23.95	NIGEL MANSELLS WORLD CHAMPIONSHIP	19.95	19.95
BAT 2	24.95	24.95	NO SECOND PRIZE GREAT! GET THIS!!!	17.95	17.95
BATTLE ISLE	N/A	20.95	NOODY'S PLAYTIME	17.95	17.95
BATTLE ISLE DATA DISK	N/A	13.95	NOVA 9 1MEG	N/A	22.95
BIRDS OF PREY 1MEG	N/A	23.95	OUTLANDER *	20.95	20.95
BLACK CRYPTS	N/A	17.95	PAPERBOY 2	N/A	15.95
BUSHBUCK *	N/A	19.95	PGA TOUR GOLF + DATA DISK	N/A	19.95
CAESAR	19.95	19.95	PGA TOUR DATA DISK	N/A	12.95
CAMPAIGN	24.95	24.95	PINBALL DREAMS	N/A	16.95
CARTOON COLLECTION (COMP)	16.95	16.95	PINBALL FANTASIES	N/A	19.95
CASTLES	19.95	19.95	PERFECT GENERAL	N/A	22.95
CASTLES DATA DISK	13.95	13.95	PERFECT GENERAL DATA DISK *	N/A	16.99
CASTLE OF DR BRAIN	N/A	24.95	POOLS OF DARKNESS	N/A	21.55
CELTIC LEGENDS	20.95	20.95	POPULOUS 2 PLUS	24.95	24.95
CHAOS ENGINE	17.95	17.95	POPULOUS 2 CHALLENGE	11.95	11.95
CIVILISATION 1MEG	23.55	23.55	POWERMONGER	N L A	19.95
COVERT ACTION	22.95	22.95	POWERMONGER WW1 DATA DISK	11.95	11.95
CRUISE FOR THE CORPSE	18.95	18.95	PREMIER 1MEG	N/A	20.95
CURSE OF ENCHANTIA *	N/A	23.95	PREMIER MANAGER	17.95	17.95
CYBERSPACE *	N/A	19.95	PROJECT X 1MEG	N/A	17.95
D'GENERATION	12.95	12.95	PROPHECY	19.95	19.95
DAILYSPORT COVER STRIP POKER	N/A	17.95	PUSHOVER (PUZZLE)	17.95	17.95
DARKMERE *	N/A	17.95	PUTTY	17.95	17.95
DARKSEED	24.95	24.95	PSYCHOS SOCCER SELECTION COMP	19.95	19.95
DREADNOUGHTS *	24.99	24.99	RAILROAD TYCOON	22.95	22.95
DOODLEBUG	17.95	17.95	RAMPART	17.95	17.95
DUNGEON MASTER + CHAOS	19.95	19.95	REACH FOR THE SKYS *	19.95	19.95
DYNA BLASTER/BOMBERMAN	20.95	20.95	RISE OF THE DRAGON	N/A	24.95
DAGONS LAIR 3 *	20.95	20.95	ROAD RASH	19.95	19.95
E L I T E 2 *	22.95	22.95	ROBIN HOOD ADVENTURE	17.95	17.95
EVIRA 2 THE JAWS OF CERBERUS	N L A	23.95	ROBOCOP 3	17.95	17.95
EPIC 1MEG	19.95	19.95	RULES OF ENGAGEMENT	N/A	17.95
EUROPEAN FOOTBALL CHAMP	17.95	17.95	SABRE TEAM	17.95	17.95
EYE OF THE BEHOLDER	N/A	20.55	SECOND SAMURAI *	19.95	19.95
EYE OF THE BEHOLDER 2 1MEG	N/A	22.95	SENSIBLE SOCCER 92/93 ISSUE 2	17.95	17.95
EYE OF THE STORM *	19.95	19.95	SHADOWLANDS	19.95	19.95
F 15 STRIKE EAGLE 2 1MEG	22.55	22.55	SHADOWWORLDS 1 MEG	17.95	17.95
FALCON 3 *	24.95	24.95	SHADOW OF THE BEAST 3	19.95	19.95
FASCINATION	19.95	19.95	SHUTTLE SIM	20.50	20.50
FIRE AND ICE	17.95	17.95	SILENT SERVICE 2 1MEG	22.95	22.95
FIREFORCE	N/A	17.95	SIM EARTH *	N/A	29.95
FLOOR 13	20.95	20.95	SIM ANT 1MEG	N/A	22.95
FOOTBALL BOSS *	16.95	16.95	SIM CITY/POPULOUS	19.95	19.95
FOOTBALL MANAGER 3 *	16.95	16.95	SUMMER CHALLENGE *	T B A	T B A
G LOCK	17.95	17.95	SPACE CRUSADE	17.95	17.95
GLOBAL EFFECT	24.95	19.95	SPACE QUEST 1V	N/A	22.95
GOBLINS	17.95	17.95	SPECIAL FORCES	22.95	22.95
GOBLINS 2	19.95	19.95	SPORTS BEST (COMP)	16.95	16.95
GRAHAM TAYLORS FOOTBALL CHALLENGE	17.95	17.95	STALINGRAD	N/A	17.95
G U N S H I P 2000 *	N/A	23.95	STREET FIGHTER 2 (1 MEG)	18.50	18.50
GUY SPY	19.95	19.95	STRIKE FLEET *	17.95	17.95
HAND OF ST JAMES *	19.95	19.95	STRIKER	17.95	17.95
HARLEQUIN	17.95	17.95	SUPER TETRIS	17.95	17.95
HARPOON V 2 WITH BATTLE SET 2	N/A	22.95	SWORD OF HONOUR	17.95	17.95
HARPOON BATTLE SET 3	N/A	11.95	TV SPORTS BOXING	N/A	13.95
HARPOON BATTLE SET 4	N/A	11.95	TV SPORTS BASEBALL	N/A	13.95
HARPOON EDITOR (NOT PLUS)	N/A	13.95	TEARAWAY THOMAS	N/A	17.95
HEAD TO HEAD F19 + MIG 29 S/FULCRUM	23.95	23.95	TEAM YANKEE 2 (PACIFIC ISLANDS)	19.95	19.95
HEART OF CHINA	23.95	23.95	THE GAMES (ESPAÑA) 92	19.95	19.95
HEROQUEST 2 *	N L A	24.99	THE HUMANS	N/A	19.95
HISTORYLINE 1914-1918 *	T B A	T B A	THE LOST TREASURES OF INFOCOM	20.95	20.95
HOOK 1MEG	17.95	17.95	TRANSACTICA *	19.95	19.95
INDIANA JONES FATE OF ATLANTIS ADV 1MEG	24.95	24.95	TREASURES OF THE SAVAGE FRONTIER	N/A	21.95
INDIANA JONES FATE OF ATLANTIS ARCADE	17.95	17.95	TRODDERS	17.95	17.95
INTERNATIONAL SPORTS CHALLENGE	19.95	19.95	TROLLS	17.95	17.95
ISHAR LEGEND OF THE FORTRESS 1MEG	19.95	19.95	UNIVERSAL MONSTERS *	17.95	17.95
JACK NICKLAUS UNLIMITED GOLF 1MEG	N/A	20.95	UTOPIA TWIN PACK	19.95	19.95
JACK NICKLAUS COURSES VOL 4	N/A	11.95	VIKINGS FIELD OF CONQUEST	N/A	18.95
JACK NICKLAUS COURSES VOL 5	N/A	13.95	VROOM	17.95	17.95
JAGUAR XJ220	N/A	17.95	VROOM DATA DISK	12.95	12.95
JIM POWER *	17.95	17.95	WESTERN FRONT *	N/A	20.95
JIMMY WHITES SNOOKER	19.95	18.95	WHEN TWO WORLDS WAR *	19.99	19.99
JOHN BARNES FOOTBALL	17.95	17.95	WING COMMANDER	N/A	24.95
JOHN MADDENS AMERICAN FOOTY	N/A	17.95	WIZ KID	17.95	17.95
JONES IN THE FAST LANE *	N/A	22.95	W W F EUROPEAN RAMPAGE *	17.95	17.95
K G B *	20.95	20.95	ZOOL (IT RIVALS SONIC) 1MEG	N/A	17.95
KICK OFF 2 FINAL WHISTLE DATA	N/A	9.95	ZOOL A1200 VERSION A GREMLIN 1STI	N/A	17.95
KICK OFF 3 *	N/A	17.95			
KNIGHTS OF THE SKY	22.95	22.95			
LASER SQUAD 2 *	17.95	17.95			
LEANDER	17.95	17.95			
LEGEND	20.55	20.55			
LEGEND OF KYRANDIA	N/A	24.95			
LEGEND OF VALOUR *	25.55	25.55			
LEISURE SUIT LARRY V	N/A	22.99			
LETHAL WEAPON 3	17.95	17.95			
LEMMINGS 2	17.95	17.95			
LEMMINGS DOUBLE PACK XMAS SPECIAL	19.95	19.95			
L I N K S H/D ONLY	N/A	25.95			
LINKS FIRESTONE DATADISK	N/A	12.95			
LINKS BOUNTIFUL DATADISK	N/A	12.95			

* PLEASE NOTE: Titles asterisked may not be released at press date but will be dispatched within 24 hour of release subject to availability. PLEASE TELEPHONE FOR ANY TITLES NOT SHOWN AS WE CANNOT SHOW ALL TITLES AVAILABLE. ALL TITLES CAN BE PUT ON BACK ORDER. REMEMBER WE HAVE NEVER DEBITED A VISA CARD YET FOR GOODS NOT SENT!!
ST OWNERS - WE KNOW THE PROBLEMS YOU ARE HAVING A TTHE MOMENT OBTAINING SOFTWARE AND WE ARE CONCERNED, BUT WE WILL TRY TO OBTAIN ANY TITLE THAT YOU MAY REQUIRE JUST ASK. WE WILL STILL SUPPORT THE ST TO THE BEST OF OUR ABILITY.

RUBY SERIOUS/EDUCATIONAL

	ST	AMIGA		ST	AMIGA
3D CONST KIT 2 *	39.95	39.95	FUN SCHOOL 3 OR 4 (UNDER 5)	17.95	17.95
A D 1 ENGLISH 11/12-13-13/14-14/15	17.50	17.50	FUN SCHOOL 3 OR 4 5-7	17.95	17.95
A D 1 MATHS 11/12-12/13-13/14-14/15	17.50	17.50	FUN SCHOOL 3 OR 4 7-11	17.95	17.95
A D 1 FRENCH 11/12-12/13-13/14-14/15	17.50	17.50	FUN SCHOOL SPECIAL PAINT & CREATE	N/A	17.95
EASY A M O S	N/A	24.95	FUN SCHOOL SPECIAL SPELLING FAIR	N/A	17.95
A M O S PRO	N/A	45.95	FUN SCHOOL SPECIAL MERLINS MATHS	N/A	17.95
A M O S	N/A	34.95	THE FRENCH MISTRESS	15.95	15.95
A M O S COMPILER	N/A	20.55	THE GERMAN MASTER	15.95	15.95
A M O S 3D	N/A	24.95	THE SPANISH TUTOR	15.95	15.95
BARNS AND PIPES PRO RRP £299.00	N/A	235.00	THE ITALIAN TUTOR	15.95	15.95
DELUXE PAINT 4	N/A	59.95	ANSWER BACK JUNIOR QUIZ 6-11 *	14.95	14.95
DELUXE VIDEO 3	N/A	54.95	ANSWER BACK SEN QUIZ 12-ADULT *	14.95	14.95
DIGICALC	N/A	29.95	MATHS ADVENTURE	18.95	18.95
DISNEY ANIMATION STUDIO	N/A	79.95	PENPAL	N/A	53.95
HOME ACCOUNTS 2	44.95	44.95	WORDSWORTH 1.1	N/A	92.95
MINI OFFICE	N/A	48.95	KINDWORDS V3	N/A	39.95
S T O S COMPILER	17.95	N/A			

*All FactFiles for Answer Back available @ £9.99

RUBY BUDGETS

	ST	AMIGA		ST	AMIGA
ADVANCED DESTROYER SIM	7.99	7.99	JAMES POND	5.99	5.99
ARCADE FRUIT MACHINE SIM	5.99	5.99	JET SET WILLIE	N/A	7.99
BADLANDS	5.99	5.99	KICK OFF 2 EUROPE	5.99	5.99
BATTLEHAWKS 1942	12.99	12.99	KICK OFF EXTRA TIME	5.99	5.99
BLADE WARRIOR	N/A	5.99	MANCHESTER UNITED	7.99	7.99
COUNT DUCKULA 2	6.99	6.99	MIDWINTER	11.99	11.99
DEMON BLUE	5.99	5.99	MOTOR HEAD	14.99	14.99
F16.COMBAT PILOT	7.99	7.99	PANG	5.99	5.99
FALCON	13.99	13.99	PRINCE OF PERSIA	6.99	6.99
FALCON COUNTER STRIKE	8.99	8.99	R TYPE	5.99	5.99
FALCON FIRE FIGHT	8.99	8.99	RAINBOW ISLANDS	5.99	5.99
FIRST DIVISION MANAGER	5.99	5.99	SILKWORM	7.99	6.99
FORGOTTEN WORLDS	5.99	5.99	SOCCER PINBALL	N/A	5.99
FUN SCHOOL 2 UNDER 6	5.99	5.99	SUPERCARS 2	7.99	7.99
FUN SCHOOL 2 6-8 YEARS	5.99	5.99	SWITCHBLADE 2	7.99	7.99
FUN SCHOOL 2 8+ YEARS	5.99	5.99	TRIVIAL PURSUIT	6.99	6.99
FUTURE WARS	11.99	11.99	TURBO CHALLENGE 1	6.99	6.99
HEAD OVER HEELS	5.99	5.99	ULTIMATE GOLF	7.99	7.99
IK +	5.99	5.99	WLD CHAMP BOXING MANAGER	5.99	5.99
INDIANA JONES LAST CRUSADE (ARCADE)	5.99	5.99	WLD CRICKET	5.99	5.99
INDIANA JONES LAST CRUSADE (ADVEN)	13.99	13.99	ZAC MCKRACKEN	12.99	12.99
JACK N GOLF	5.99	5.99			

Check out our prices on budget title, cheapest around

COMPILATIONS

SUPERFIGHTER FINAL FIGHT, WWF WRESTLEMANIA AND PITFIGHTER. THREE AMAZING GAMES ONLY £17.95	VOLUME 1 (THE BITMAP BROS) XENON, CADAVER AND SPEEDBALL 2 ALL THREE GAMES ONLY £17.95
DREAM TEAM TERMINATOR 2, THE SIMPSONS AND WWF PRICE ONLY £17.95	SPORTS MASTER EUROPEAN CHAMPIONSHIP 1992, PGA TOUR GOLF, ADVANTAGE TENNIS AND INDIANAPOLIS 500. A FANTASTIC COLLECTION ONLY £20.95 OK 1200
THE DIZZY COLLECTION FAST FOOD, KWIX SNAX, FANTASY WORLD DIZZY, TREASURE ISLAND DIZZY, MAGIC LAND DIZZY. FIVE GOOD GAMES ONLY £16.95	RAVING MAD!! RODLAND, ROBOCOP (JAMES POND 2) AND MEGA TWINS ALL THREE GAMES ONLY £17.95
DIZZY'S EXCELLENT ADVENTURES DIZZY PRINCE OF THE YOKEFOLK, SPELLBOUND DIZZY, BUBBLE DIZZY, PANK DIZZY, QUICK SNAX, GOOD FOR THE YOUNGER ONES ONLY £16.95	BIG BOX 2 BACK TO THE FUTURE 3, THE REAL GHOST BUSTERS, R-TYPE, SINBAD, IK+ ARMALYTE, TV SPORTS FOOTBALL, BOMBUZAL, DEF OF THE EARTH AND SHANGHAI (MAI YONG) BIG COMP FOR ONLY £19.95 GREAT VALUE
RAINBOW COLLECTION BUBBLE BOBBLE, RAINBOW ISLAND AND NEW ZEALAND STORY. GREAT COMP FOR THE YOUNGER ONES THREE FANTASTIC GAMES ONLY £13.95	MAGIC WORLDS STORM MASTER, DRAGONS BREATH AND CRYSTALS OF ARBOREA. ALL THREE AMAZING GAMES ONLY £17.95
SOCCER MANIA FOOTBALL MANAGER 2, GAZZAS SOCCER, MICROPROSE SOCCER AND FOOTBALL MANAGER 2 WORLD CUP EDITION FOUR GAMES ONLY £13.95 NOT PLUS, 600 1200	
STRATEGY MASTERS *DEUTEROUS, POPULOUS, HUNTER, SPIRIT OF EXCALIBUR AND CHESS PLAYER 2150 ALL FIVE GAMES FOR ONLY £21.95 *DEUTEROUS ONLY ST. BATTLEMASTER ON AMIGA.	
FANTASTIC WORLDS REALMS, PIRATES, WONERLAND, POPULOUS 1 AND MEGALOMANIA GREAT COMP FOR ONLY £23.95	

**BRING THIS ADVERT TO
OUR SHOP AND BUY A
MINIMUM OF TWO FULL
PRICED TITLES AT OUR
LOW MAIL ORDER PRICES.
OFFER VALID UNTIL
31st March 1993.**

HARDWARE

CRUISER (BLACK)	9.99	MANTA RAY AUTOFIRE GOOD HANDHELD	10.50
NAVIGATOR	12.50	ZYDEC MOUSE ST/AMIGA GOOD REPLACEMENT	13.99
SPEEDKING AUTOFIRE	9.50	ZYDEC ROLLER BALL GREAT!! ST/AMIGA	36.99
ZIP STICK SUPERPRO	12.50	1MEG UPGRADE AMIGA 600	49.98
DELTA 3A ANALOGUE AMIGA ONLY	16.50	1MEG UPGRADE AMIGA 500+	46.99
SPEEDKING ANALOGUE AMIGA	13.99	512K UPGRADE AMIGA WITH CLOCK	28.99
QUICKJOY JET FIGHTER	11.99	80 CAP DISK BOX	9.50
QUICKJOY MEGASTAR SV133 ARCADE STYLE	20.99	GAME GEAR TV TUNER	59.99
QUICKJOY TOPSTAR SV127 TOP RATE	20.50	HANDYBOY THE BIZ!!	25.99

RUBYSOFT, (Dept AMF)
96 Lillie Road, London
SW6 7SR, England
Tel: 071 381 8998
or: 071 610 1703
Fax: 071 610 1703

*Shop prices will differ from those advertised



Credit cards debited only on day of despatch. Tel: 071 381 8998/071 610 1703 Fax: 071 610 1703

Please charge my Access/Visa No: Valid from: Expiry date:

ORDER FORM Date

Please supply me with the following for Name

Computer Address

Titles Price

Postcode

Tel

CITIZEN PRINTERS FROM SILICA SYSTEMS

- **FREE DELIVERY** Next Day - Anywhere in the UK mainland
- **FREE STARTER KIT** Worth £57.58 - With Citizen dot matrix printers from Silica
- **2 YEAR WARRANTY** (including the dot matrix printer head)
- **WINDOWS 3.1** Free Windows 3.1 driver with Starter Kit
- **FREE HELPLINE** Technical support helpline open during office hours
- **FREE COLOUR KIT** With every Swift 9



- FREE STARTER KIT INCLUDES:**
- 3 1/2" Disk with Amiga Print Manager (see right)
 - 3 1/2" Disk with Windows 3.1 Driver
 - 1.8 Metre Parallel Printer Cable
 - 200 Sheets of Continuous Paper
 - 100 Continuous Tractor Feed Address Labels
 - 5 Continuous Envelopes on Tractor Feed

AMIGA PRINT MANAGER V2.01
For faster printing from your Amiga, with clearer images and more vibrant colours. Available free of charge as part of the Silica Printer Starter Kit.

Features include:

- Improved Image Smoothing
- Gamma/Colour Correction
- Image Scaling
- Colour Separation
- Reduces/Eliminates Banding

KIT VALUE £49 +VAT

CITIZEN PRINTERS WITH 2 YEAR WARRANTY

24 PIN 270 CPS 80 COLUMN



- Citizen Swift 200 - 24 pin - 80 column
 - 270cps SD (15cps), 216 cps Draft, 72cps LQ
 - 8K Printer Buffer (40K max) + 6 LQ Fonts
 - Parallel Interface
 - Graphics Resolution: 360 x 360 dpi
 - Epson, IBM, & NEC P20 Emulations
 - Quarter Printing and Auto Set Facility
 - Ultra Quiet Mode - 43dB(A)
 - Colour Kit - Optional Extra (See Below)
 - FREE Silica Printer Starter Kit
- SWIFT 200**
RRP £269
SILICA STARTER KIT £49
TOTAL VALUE: £318
SAVING: £139
SILICA PRICE: £179
- £179**
+VAT=£210.33 - PRI 2490

9 PIN 144 CPS 80 COLUMN



- Citizen 120D+ - 9 pin
 - 144cps Draft, 30cps NLQ
 - 4K Printer Buffer + 2 Fonts
 - Parallel or Serial Interface
 - Graphics Resolution: 240 x 240dpi
 - Epson and IBM Emulation
 - Pull tractor & bottom feed
 - FREE Silica Printer Starter Kit
- CITIZEN 120D+**
RRP £199
SILICA STARTER KIT £49
TOTAL VALUE: £248
SAVING: £133
SILICA PRICE: £115
- £115**
+VAT=£135.13 - PRI 2120
- The Citizen 120D printer comes supplied with a parallel interface as standard. If you require a serial interface instead, please state ref. PRI 2125 when placing your order with Silica.

RETURN THE COUPON FOR YOUR FREE COPY OF SILICA'S NEW CITIZEN CATALOGUE

PERIPHERALS & ACCESSORIES

STAND OFFER

PRINTER NOT INCLUDED **NEW LOW PRICE!**

CITIZEN PRINTER STAND
For Swift 9, 24, 24e, 200, 240 and 224 Printers

- Helps keep pace with Citizen Printer's powerful paper handling
- Robust & Durable Construction
- Saves space and protects continuous stationery from dust and damage
- Compatible with bottom and rear feed operation

RRP £28
£19
+VAT=£22.33 - PRI 1242

SHEET FEEDERS

PRA 1200 120D	£71.38
PRA 1215 124D/224/Swift 9/24	£88.70
PRA 1228 124D/224/Swift 9/24	£42.00

SERIAL INTERFACES

PRA 1189 120D+	£56.45
PRA 1209 Swift 9/9x/124D/224	£32.25
PRA 1709 Swift 24/24x/24e	£26.38

32K MEMORY EXPN

PRA 1753 124D/224/Swift 24	£13.10
----------------------------	--------

PRINTER STAND

PRA 1242 124D/224/Swift 9/24	£22.33
PRA 1274 Swift 9X/24X	£30.66

ORIGINAL RIBBONS

RIB 3520 120D/Swift 9 Black	£2.91
RIB 3949 Swift 9x Black	£7.15
RIB 3924 124D/Swift 24 Black	£4.70
RIB 3936 224/Swift 9/24 Colour	£15.63
RIB 3248 PN48 Single Strike	£3.61
RIB 3348 PN48 Multi Strike	£3.61

COLOUR KITS

PRA 1236 224/Swift 9/24e/200/240	£35.25
PRA 1240 Swift 9x/24x	£35.25

PN48 ACCESSORIES

PRA 1148 PN48 Battery	£46.70
PRA 1155 PN48 Cable Extn	£29.37
PRA 1162 PN48 Car Adaptor	£16.80

24 PIN 300 CPS 80 COLUMN



- Citizen Swift 240/240C - 24 pin - 80 col
 - 300cps SD (15cps), 240 cps Draft, 80cps LQ
 - 8K Printer Buffer - 40K maximum
 - 9 LQ Fonts + 2 Scalable Fonts (8-40pts)
 - Font Cartridge Slot - for plug in 'style' fonts
 - Parallel Interface
 - Graphics Resolution: 360 x 360dpi
 - Epson, IBM, NEC P20 & CEL Emulations
 - Quarter Printing Facility
 - Auto Set Facility - Bi-directional I/F, Auto Emulation Detection
 - Command Vue IV Front Control Panel
 - Ultra Quiet Mode - 43dB(A)
 - Colour Printing Standard - Swift 240C, Colour Printing Optional - Swift 240
 - FREE Silica Printer Starter Kit
- SWIFT 240 MONO**
RRP £339
STARTER KIT £49
TOTAL VALUE: £388
SAVING: £149
SILICA PRICE: £239
- SWIFT 240C COLOUR**
RRP £359
STARTER KIT £49
TOTAL VALUE: £408
SAVING: £149
SILICA PRICE: £259
- £239**
+VAT=£280.83 - PRI 2560
- £259**
+VAT=£304.33 - PRI 2571

9 PIN 192 CPS 80 COLUMN



- Citizen Swift 9 - 9 pin - 80 col
 - 192cps Draft, 48cps NLQ
 - 8K Printer Buffer
 - 3 Fonts
 - Parallel Interface
 - Graphics Res: 240 x 240dpi
 - Epson and IBM Emulation
 - Proportional Spacing
 - FREE Colour Kit
 - FREE Silica Printer Starter Kit
- SWIFT 9**
RRP £199
COLOUR KIT £38
SILICA STARTER KIT £49
TOTAL VALUE: £286
SAVING: £127
SILICA PRICE: £159
- £159**
+VAT=£186.83 - PRI 2209

- Citizen Swift 24x - 24 pin - 136 col
- 192cps Draft, 64cps NLQ
- 8K Printer Buffer + 4 Fonts
- Parallel Interface
- Graphics Resolution: 360 x 360dpi
- Epson, IBM and NEC P6 Emulation
- Colour Option Available
- FREE Silica Printer Starter Kit

RRP £485
SILICA STARTER KIT £49
TOTAL VALUE: £534
SAVING: £230
SILICA PRICE: £299

£299
+VAT=£354.33 - PRI 2574

192 CPS 136 COLUMN

2 YEAR WARRANTY **NEW LOW PRICE!**

FREE! STARTER KIT WORTH £49 SEE ABOVE

- Citizen PN48 Notebook Printer
- Non-impact Printing on Plain Paper
- 53cps LQ - 4K Buffer + 2 Fonts
- Rear and Bottom Paper Loading
- Parallel Interface
- Graphics Res: 360 x 360dpi
- Epson, IBM, NEC P6 & Citizen Emulation
- Power: Mains, Battery or Car Adaptor

RRP £325
TOTAL VALUE: £325
SAVING: £126
SILICA PRICE: £199

£199
+VAT=£223.83 - PRI 2100

64 CPS 80 COLUMN

2 YEAR WARRANTY **NEW LOW PRICE!**

- Citizen Projet - inkjet - 80 col
- 360cps Draft, 120cps NLQ
- 50 Nozzle Head - Whisper Quiet 47dB(A)
- 8K Printer Buffer + 3 Fonts
- Optional HP Compatible Font cards
- Parallel Interface
- Graphics Res: 300x300dpi
- HP Deskjet plus emulation

RRP £496
TOTAL VALUE: £496
SAVING: £151
SILICA PRICE: £345

£345
+VAT=£405.36 - PRI 2090

360 CPS 80 COLUMN

NEW LOW PRICE! **2 YEAR WARRANTY**

SILICA SYSTEMS OFFER YOU

- **FREE OVERNIGHT DELIVERY:** On all hardware orders shipped in the UK mainland.
- **TECHNICAL SUPPORT HELPLINE:** Team of technical experts at your service.
- **PRICE MATCH:** We normally match competitors on a "Same product - Same price" basis.
- **ESTABLISHED 14 YEARS:** Proven track record in professional computer sales.
- **£12 MILLION TURNOVER (with 60 staff):** Solid, reliable and profitable.
- **BUSINESS + EDUCATION + GOVERNMENT:** Volume discounts available 081-308 0888.
- **SHOWROOMS:** Demonstration and training facilities at our London & Sidcup branches.
- **THE FULL STOCK RANGE:** All of your requirements from one supplier.
- **FREE CATALOGUES:** Will be mailed to you with offers + software and peripheral details.
- **PAYMENT:** Major credit cards, cash, cheque or monthly terms.

Before you decide when to buy your new printer, we suggest you think very carefully about WHERE you buy it. Consider what it will be like a few months after you have made your purchase, when you may require additional peripherals and accessories, or help and advice. And, will the company you buy from contact you with details of new products? At Silica Systems, we ensure that you will have nothing to worry about. We have been established for almost 14 years and, with our unrivalled experience and expertise, we can now claim to meet our customers' requirements with an understanding which is second to none. But don't just take our word for it. Complete and return the coupon now for our latest FREE literature and begin to experience the "Silica Systems Service".

MAIL ORDER HOTLINE
081-309 1111



MAIL ORDER: Order Lines Oper: Mon-Sat 9.00am-6.00pm No Late Night Opening	1-4 The Mews, Hatherley Rd, Sidcup, Kent, DA14 4DX	Tel: 081-309 1111 Fax No: 081-308 0608
LONDON SHOP: Opening Hours: Mon-Sat 9.30am-6.00pm No Late Night Opening	52 Tottenham Court Road, London, W1P 0BA	Tel: 071-580 4000 Fax No: 071-323 4737
LONDON SHOP: Opening Hours: Mon-Fri 9.30am-7.00pm (Sat close 6.30pm) Late Night: Thursday - 8pm	Selfridges (1st Floor), Oxford Street, London, W1A 1AB	Tel: 071-629 1234 Extension: 3914
SIDCUP SHOP: Opening Hours: Mon-Sat 9.00am-5.30pm Late Night: Friday - 7pm	1-4 The Mews, Hatherley Rd, Sidcup, Kent, DA14 4DX	Tel: 081-302 8811 Fax No: 081-309 0017
ESSEX SHOP: Opening Hours: Mon-Fri 9.30am-5.30pm (Sat 9.00am-6.00pm) No Late Night Opening	Keddies (2nd Floor), High Street, Southend-on-Sea, Essex, SS1 1LA	Tel: 0702 468039 Fax No: 0702 462363

To: Silica Systems, AMFOR-0393-55, 1-4 The Mews, Hatherley Rd, Sidcup, Kent, DA14 4DX

PLEASE SEND A BROCHURE ON THE CITIZEN RANGE

Mr/Mrs/Miss/Ms: Initials: Surname:

Company Name (if applicable):

Address:

Postcode:

Tel (Home): Tel (Work):

Which computer(s), if any, do you own?

THEY LIVE AGAIN

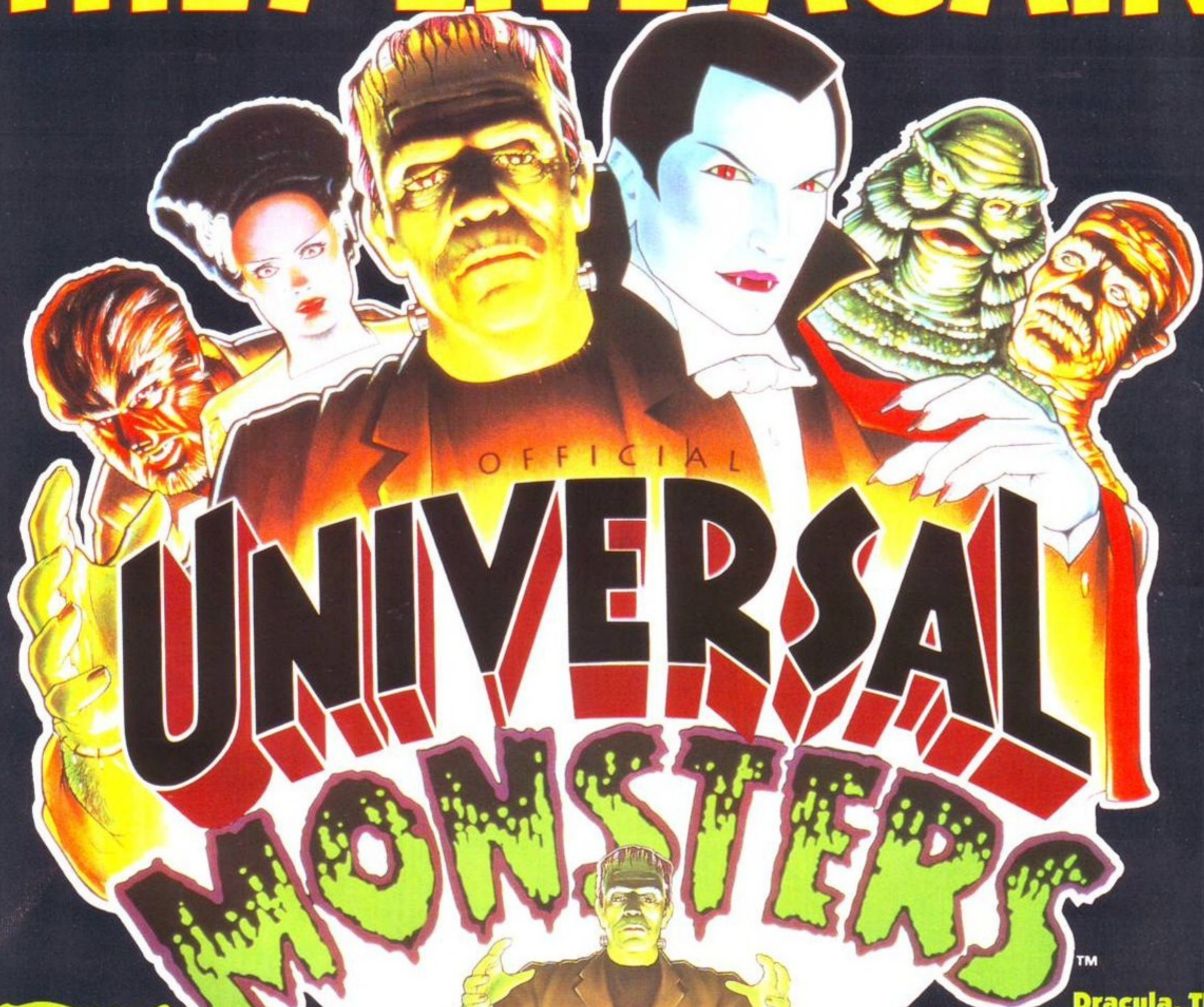

UNIVERSAL MONSTERS™



Dracula, The Frankenstein Monster, The Mummy, The Wolf Man, The Bride of Frankenstein and The Creature from the Black Lagoon. Classic monsters from a movie age gone by. But more than that... creatures from our oldest dreams and our darkest nightmares. They have met and battled before, but now they are back. Back to form an unholy alliance to make our worst fears turn into a terrifying reality.

ATARI ST . CBM AMIGA

TM & © Universal City Studios, Inc. All rights reserved. Licensed by MCA / Universal Merchandising, Inc.

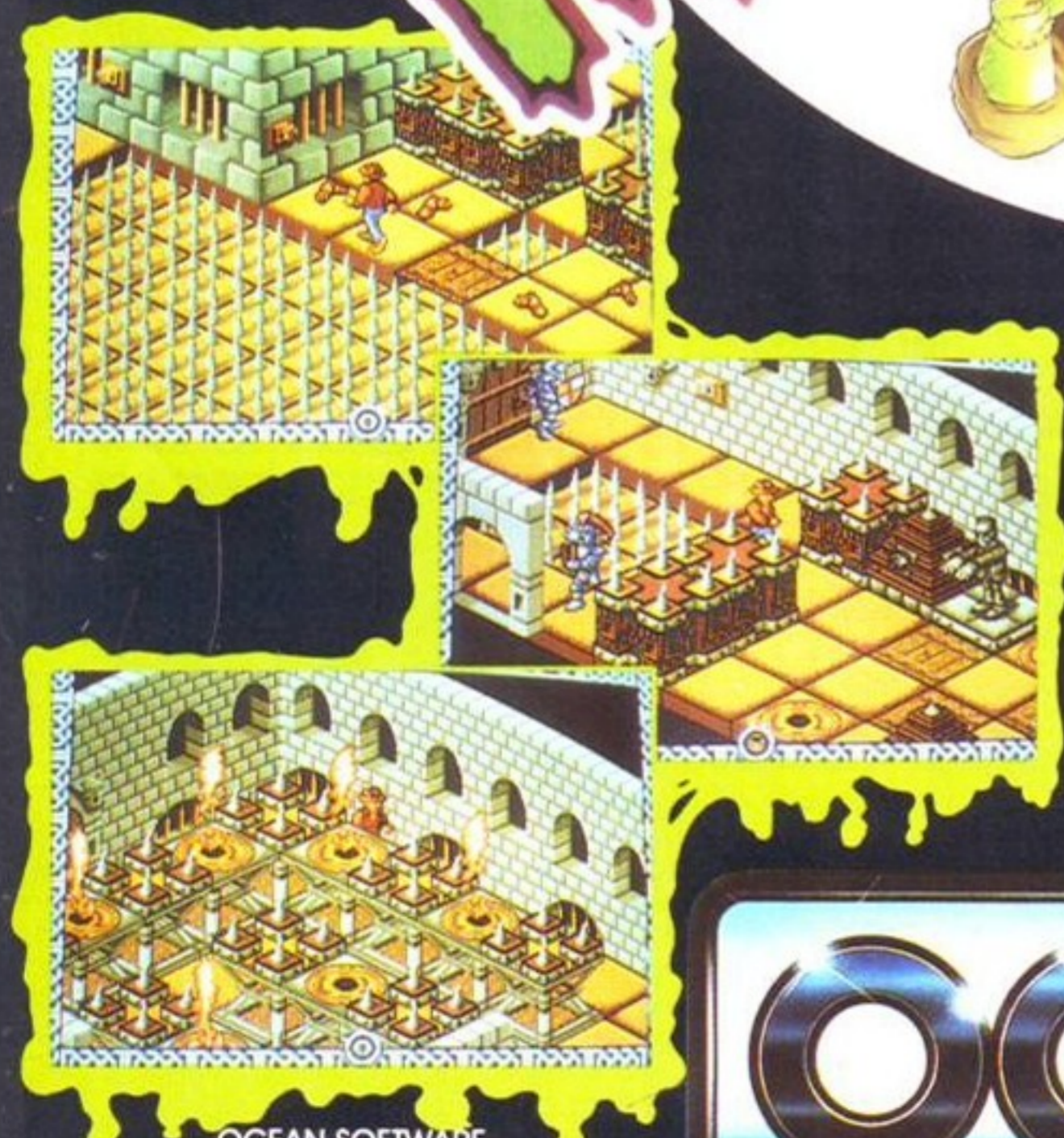

OCEAN SOFTWARE
2 CASTLE STREET
CASTLEFIELD
MANCHESTER · M3 4LZ
TEL: 061 832 6633
FAX: 061 834 0650



THE BRIDE OF FRANKENSTEIN © 1925 UNIVERSAL PICTURES CORPORATION
Renewed 1962 by UNIVERSAL PICTURES COMPANY, INC. All rights reserved.
Licensed by MCA/Universal Merchandising, Inc.
THE CREATURE FROM THE BLACK LAGOON © 1954 UNIVERSAL PICTURES COMPANY, INC.
Renewed 1982 by UNIVERSAL CITY STUDIOS, INC. All rights reserved.
Licensed by MCA/Universal Merchandising, Inc.
DRACULA © 1931 UNIVERSAL PICTURES CORPORATION
Renewed 1958 by UNIVERSAL PICTURES COMPANY, INC. All rights reserved.
Licensed by MCA/Universal Merchandising, Inc.
FRANKENSTEIN © 1931 UNIVERSAL PICTURES CORPORATION
Renewed 1959 by UNIVERSAL PICTURES COMPANY, INC. All rights reserved.
Licensed by MCA/Universal Merchandising, Inc.
THE MUMMY © 1932 UNIVERSAL PICTURES CORPORATION
Renewed 1960 by UNIVERSAL PICTURES COMPANY, INC. All rights reserved.
Licensed by MCA/Universal Merchandising, Inc.
THE WOLF MAN ® & © 1941 UNIVERSAL PICTURES COMPANY, INC.
Renewed 1969 by UNIVERSAL PICTURES. All rights reserved.
Licensed by MCA/Universal Merchandising, Inc.

Who'd be a struggling artist, eh? Well, for a start, you're struggling – and nobody wants to be that. Secondly, you're an artist – which means that the loathsome, non-creative garbage who make up the majority of the uncultured rabble don't understand your work. You're making these broad, dazzlingly original statements on the passionless, but multi-layered socio-sexual framework of human relations, by throwing some paint on to a canvas in a rather arbitrary fashion. And all people do is stare blankly, shake their heads and say: "It's crap, isn't it?"

Which leads us neatly to the game. Somewhere in the dark, universally misunderstood realms of the programmer's mind, there must have been a point to all of this. He must, at some time, have been visited by a kind of inspirational angel, who informed him that he was destined to write a computer game based upon the exploits of a struggling artist. Foolishly, he bowed to the angel's will... and *Fatal Strokes* was born.

Manic depression

"For weeks", informs the manual, "I had suffered an overwhelming sense of depression that was like a dark, enveloping cloud of despair." Yeah, right. A dark cloud of despair not dissimilar to the one which will soon envelope those Amiga owners who stupidly waste £ 25.99 on this deeply tedious game.

Edwin Saxx, struggling artist, wanders into an art materials shop and is given a set of 'special' paints by a mystical and strangely familiar, wisened old man. He paints three masterpieces in just a few hours and collapses from exhaustion. Then he wakes to find that

Phew. Shocking stuff, eh? (We apologise for the poor nature of that last sentence. But at least we avoided some form of Viz-style, fnarr-esque wordplay on the title of the game.)

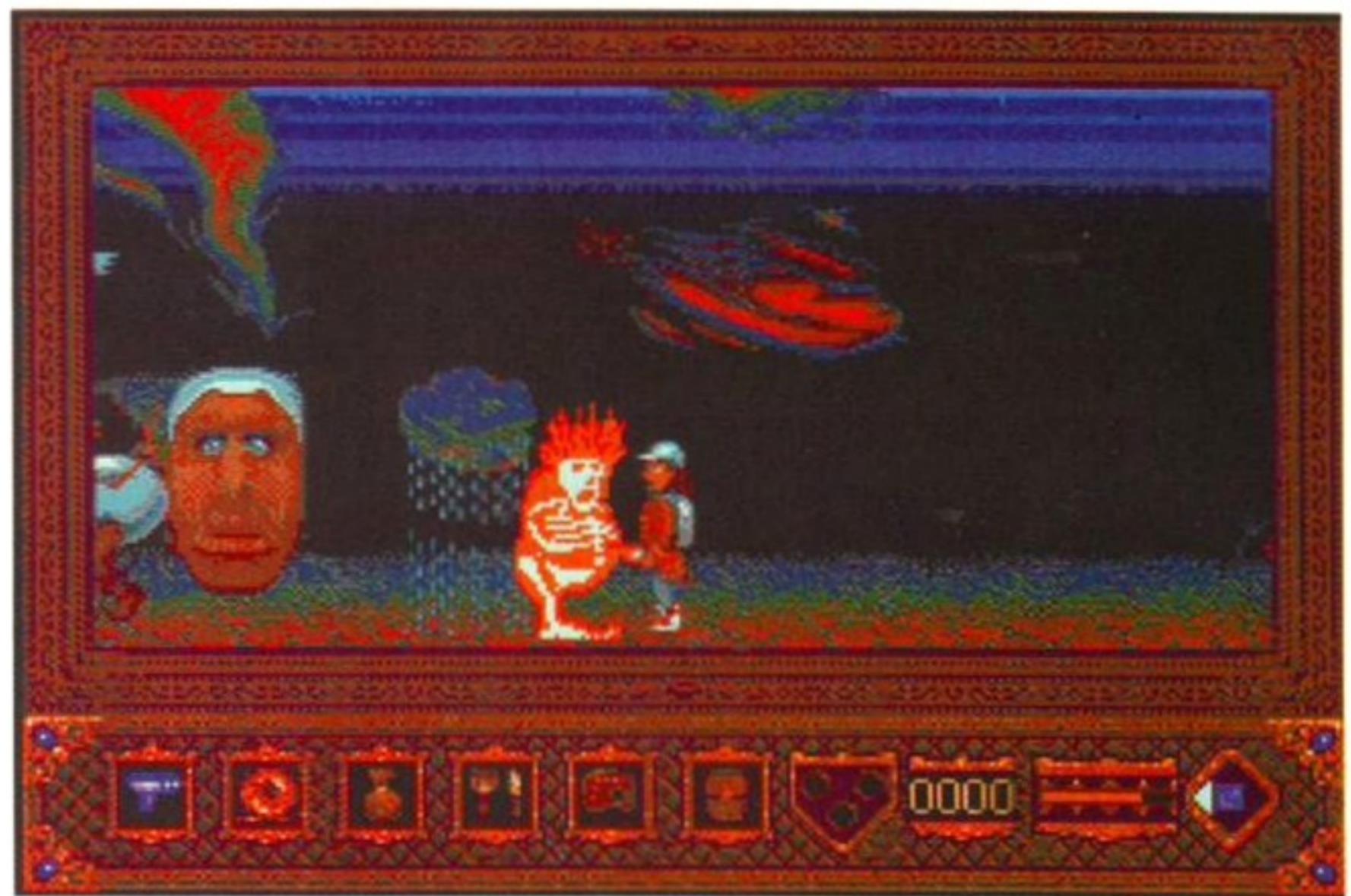

Fatal Strokes

he's been curiously transported into the domain of the paintings, and an evil sorcerer rules over all three of the picture worlds. He must collect the magic orbs, because they will restore the light to the universe, and banish the darkness into the eternal... oh, God. No. I'm sorry, I can't go on.

It really is rather naff. A fairly promising story rapidly descends into the old 'collect the sacred orbs and vanquish the evil one' wibble. Didn't this sort of thing go out with the Spectrum? Oh well, maybe the startlingly original and compelling gameplay will make up for the lack of plot interest. Here goes...

Nope. I'm afraid this really is garbage. The gameplay – using the term loosely – takes the form of a mindbendingly tiresome platform game. The concept of which appears to have been publicly humiliated, tortured, mutilated and force-fed some bizarre, angular, badly drawn, tragically flickering graphics – before being convinced, in a moment of particularly hysterical drunken insincerity, that it is OK, it is loveable, playable even.

This is, quite honestly, the kind of game that Spectrum owners would have gladly paid

£9.99 for in 1985. Just. None of the ill-conceived sub-games, or half-hearted attempts at gameplay quirks can save it. It looks like Ceefax on an off-day, plays like a dead puppy and is as appealing as superglueing yourself to the sofa, in front of videotapes of *You've Been Framed*, and between hearty swigs of Domestos, screaming the word 'noodles' every time Jeremy Beadle grins.

It's a fatality

Look – I tried. I really did try. Honest. I played it solidly for a whole evening – with the benefit of an energy-bar cheat and all the sub-game codes. I picked up all the power-ups, tried the turps gun, attempted to make sense of the map screens and defeated end-of-level guardians. I came up with the conclusion, though, that should you have actually paid for this piece of junk, you'd surely expect to be entertained to some degree – without having to grit your teeth and hope it gets good soon.

It's a shame though, because ICE seem to be a reasonably capable software house, with their previous release *Fireforce*, and their up-and-coming RPG game *Abandoned Places 2*. Despite the occasional flashes of mild interest, however, *Fatal Strokes* is unplayable, unexciting and very, very ugly. State-of-the-art. Such a shame the art is actually basket weaving.

Andy Lowe ☺

Our hero is a desperately skint artist who flies from place to place in a ludicrously expensive helicopter. It's not exactly Dostoevsky this, is it?



SUBNORMAL SUBDIVISIONS

Another downright awful aspect to *Fatal Strokes* is the stupefyingly unimaginative sub-games – the concepts behind which are nothing short of, well, familiar.



Yep, it's a trip down to memory arcade, with a game not dissimilar to *Space Invaders*. Of a sort. Move left and right. Press the fire-button at appropriate intervals. Become interminably bored.



A bit strange, this one. You have to jump and keep the balls in the air. Oh, you also have to avoid the two floating guardian thingies. Not particularly exciting, really. Nothing different there then.

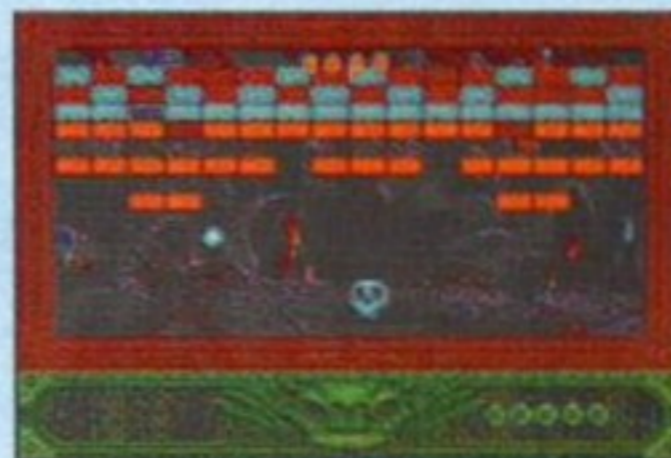

This is more like it. You move the skull left and right and bounce the ball on to the bricks. When you've bashed away at all the bricks, you've completed it. The snag is you have to stay awake.

Fatal Strokes
ICE ■ £25.99

- Dull and painfully derivative.
- Unresponsive and awkward controls.
- Horrifyingly low fun element. A damned chore to get through.
- Laughably naff and sloppy graphics.

Verdict 17%

CRAZY SPRING

LOOKING FOR DISKS & BOXES???
LOOK NO FURTHER
 REMEMBER ALL DISKS SOLD BY BCS ARE FULLY GUARANTEED

DISKS ! DISKS ! DISKS !

100% CERTIFIED ERROR FREE
 PLUS FREE COLOUR CODED LABELS

50 3.5" DS/DD	£23.99
100 3.5" DS/DD	£41.99
150 3.5" DS/DD	£58.99
200 3.5" DS/DD	£76.99
300 3.5" DS/DD	£114.99
400 3.5" DS/DD	£152.99
500 3.5" DS/DD	£183.99
1000 3.5" DS/DD.....	CALL FOR LATEST PRICE

All prices include VAT/free labels .

REMEMBER, THESE PRICES INCLUDE FREE DELIVERY

PLEASE PHONE FOR LATEST PRICES DUE TO POSSIBLE INTRODUCTION OF EC TARIFFS ON DISKS

DISKS + 100 CAP LOCKABLE BOXES

100% CERTIFIED ERROR FREE
 PLUS FREE COLOUR CODED LABELS

50 3.5" DS/DD + 100 cap box.....	£26.99
100 3.5" DS/DD + 100 cap box.....	£44.99
150 3.5" DS/DD + 100 cap box.....	£61.99
200 3.5" DS/DD + 2 x 100 cap boxes	£82.99
300 3.5" DS/DD + 3 x 100 cap boxes.....	£123.99
400 3.5" DS/DD + 4 x 100 cap boxes.....	£164.99
500 3.5" DS/DD + 5 x 100 cap boxes.....	£195.99
1000 3.5" DS/DD + 10 x 100 cap boxes.....	£ call

All prices include VAT / free labels

REMEMBER THESE PRICES INCLUDE FREE DELIVERY

PLEASE PHONE FOR LATEST PRICES DUE TO POSSIBLE INTRODUCTION OF EC TARIFFS ON DISKS

DISKS + 80 CAP BANX BOXES

100% CERTIFIED ERROR FREE
 FREE COLOUR CODED LABELS

50 3.5" DS/DD + 80 Cap Banx Box.....	£33.99
100 3.5" DS/DD + 80 Cap Banx Box.....	£49.99
150 3.5" DS/DD + 2 x 80 Cap Banx Boxes.....	£77.99
200 3.5" DS/DD + 2 x 80 Cap Banx Boxes.....	£95.99
300 3.5" DS/DD + 4 x 80 Cap Banx Boxes.....	£152.99
400 3.5" DS/DD + 5 x 80 Cap Banx Boxes.....	£197.99
500 3.5" DS/DD + 6 x 80 Cap Banx Boxes.....	£237.99

All prices include VAT/ free labels & free delivery

PLEASE PHONE FOR LATEST PRICES DUE TO POSSIBLE INTRODUCTION OF EC TARIFFS ON DISKS

DISKS + 150 CAP POSSO BOXES

100% CERTIFIED ERROR FREE
 FREE COLOUR CODED LABELS

50 3.5" DS/DD + 150 Cap Posso Box.....	£37.99
100 3.5" DS/DD + 150 Cap Posso Box.....	£55.99
150 3.5" DS/DD + 150 Cap Posso Box.....	£73.99
200 3.5" DS/DD + 2 x 150 Cap Posso Boxes.....	£106.99
300 3.5" DS/DD + 2 x 150 Cap Posso Boxes.....	£144.99
400 3.5" DS/DD + 3 x 150 Cap Posso Boxes.....	£196.99
500 3.5" DS/DD + 4 x 150 Cap Posso Boxes.....	£241.99

All prices include VAT/ free labels & free delivery

PLEASE PHONE FOR LATEST PRICES DUE TO POSSIBLE INTRODUCTION OF EC TARIFFS ON DISKS

3.5 DELUXE STORAGE BOXES

10 Capacity	£1.00
40 Capacity (Lockable).....	£4.10
100 Capacity (Lockable).....	£4.50

5.25 STORAGE BOXES

10 Capacity	£1.00
50 Capacity (Lockable).....	£5.10
100 Capacity (Lockable).....	£5.90

STACKABLE BOXES

3.5" 80 Cap Banx Lockable Box	£10.95
3.5" 150 Cap Posso Box	£15.50
5.25" 70 Cap Posso Box	£16.50

3.5" HIGH DENSITY DISKS

100% ERROR FREE / FREE COLOUR CODED LABELS

60P EACH **£61** For 100 incl delivery/labels/VAT

100% CERTIFIED ERROR FREE

5.25" DS/DD Disks	21p each
5.25" DS/HD Disks	39p each

BRANDED 3.5" DISKS (KAO/TKD)

10 3.5" DS/DD	£6.50
10 3.5" DS/HD	£10.50

BOX OF PAPER 11 X 9.5, 60GMS MICROPERF 2,000 SHEET...£11.75

BOX OF A4 PAPER, 70GMS MICROPERF 2,000 SHEETS...£12.95

LIMITED OFFER
A500 PLUS
CARTOON CLASSIC
PACK £239.99



GVP 85MB A600/A1200
INTERNAL HARD DRIVE
£285.99

PRINTER RIBBONS

PRINTER	BLACK RIBBONS		COLOUR RIBBONS
	BRANDED	COMPATIBLE	BRANDED
Citizen 120D	£3.40	£2.70	N/A
Citizen Swift 9	£3.40	£2.70	£15.30
Citizen Swift 24/24E/224	£4.70	£2.70	£15.30
Panasonic 1124	£8.50	£3.58	N/A
Star LC-10	£4.47	£3.06	£6.70
Star LC-20	£4.47	£3.06	N/A
Star LC200	£6.11	£4.70	£12.30
Star LC24 10/15	£5.58	£3.53	N/A
Star LC24-200	£5.58	£3.53	£13.25

CALL FOR PRICES ON ANY RIBBONS NOT LISTED EG. PANASONIC/EPSON ETC.

INKJET CARTRIDGES & REFILLS

HP Deskjet Black Ink Cartridge	£14.98
HP Deskjet Black Dual Capacity Ink Cartridge.....	£23.95
HP Deskjet 500C Colour Ink Cartridge.....	£26.96
Canon BJ10e/ex Black Ink Cartridge.....	£16.99
Black Twin Refill Kit	£14.98
Colour Twin Refill kit	£14.98
500C Colour Refill Kit	£14.98
Amiga Colour Separation Software	£39.95

OFFERS FROM BCS LTD

AMIGAS! AMIGAS! AMIGAS!

BCS ORDER HOTLINE 0273 506269 962696 PHONE NOW

PACK 1

NEW AMIGA 600
THE WILD, THE WEIRD, THE WICKED PACK
+ SUPERBASE PERSONAL SOFTWARE

A600 1MB FDD
DELUXE PAINT III
MICROPROSE GRAND PRIX
SILLY PUTTY
PUSHOVER
SUPERBASE PERSONAL
MOUSE ETC
ON-SITE WARRANTY
ONLY £299.99

PACK 2

NEW AMIGA 1200
PLUS 85MB
INTERNAL
GVP HARD DRIVE

ONLY £679.99
LIMITED STOCK

PACK 3

NEW AMIGA 600 BCS PACK

A600 1MB FDD
SUPERBASE PERSONAL SOFTWARE
MOUSE ETC.
ON-SITE WARRANTY
10 3.5" DS/DD DISKS
DISK BOX
MOUSE MAT
TAILORED DUST COVER
MICROSWITCH JOYSTICK
ONLY £294.99
LIMITED STOCK

PACK 4

BCS STARTER PACK

10 3.5 DS/DD DISKS
DISK BOX
MOUSE MAT
TAILORED DUST COVER
MICROSWITCH JOYSTICK
3.5 CLEANING KIT

ONLY £17.00

WHEN PURCHASED WITH PACK 1, 2 OR 6

NEW ZOOL PACK INCLUDING:

ZOOL
STRIKER
PINBALL DREAM
TRANSWRITE WP

ONLY £19.99 WHEN
PURCHASED WITH AN AMIGA.

PACK 5

PHILIPS CM8833 MK II
COLOUR STEREO MONITOR
LOTUS TURBO CHALLENGE
ON-SITE WARRANTY
UK SPEC'
CONNECTING LEAD
DUST COVER

ONLY 225.99

PACK 6

NEW AMIGA 1200

- 68020 PROCESSOR RUNNING AT 14.19MHZ
- 2MB CHIP RAM
- 16 MILLION COLOURS
- AA CHIP SET
- NUMERIC KEYPAD
- ON-SITE WARRANTY

ONLY £364.99
OR £389.99 with
zool pack

Limited stock - Call for latest price

GVP SERIES II HARD DRIVES & ACCELERATORS FOR A500

GVP 42MB HD8 II£289.99
GVP 80MB HD8 II£359.99
GVP 120MB HD8 II£459.99
GVP 213MB HD8 II£549.99
GVP A530 COMBO 40MHz + 42MB.....£639.99
GVP A530 COMBO 40 MHz +80MB.....£729.99
GVP A530 COMBO 40MHz + 120MB.....£819.99
GVP A530 COMBO 40MHz + 213MB.....£909.99

CALL NOW FOR PRICES ON RAM UPGRADES
FOR GVP DRIVES

1 MONTH ONLY
CITIZEN 240C PRINTER
INCLUDING lead & dustcover
only £259.99

limited stock

AMIGA BIT'S 'N' BOBS

A500 1MB UPGRADE.....£34.00
A600 1MB UPGRADE.....£42.99
A600 2MB UPGRADE.....£123.00
A600 4MB UPGRADE.....£193.00
3.5 CUMANA DISK DRIVE£54.99
INTERNAL REPLACEMENT
A500 DISK DRIVE.....£54.95

STAR/CITIZEN PRINTERS

CITIZEN 120D 9PIN MONO£129
CITIZEN SWIFT 9PIN COLOUR£179
CITIZEN 240 MONO£245
CITIZEN 240 COLOUR.....£259.99
STAR LC-200 COLOUR£199
STAR LC-24 200 COLOUR£259
SEKOSHA SL-90 MONO 24 PIN.....£185

ALL PRINTERS COME WITH LEAD & DUST COVER
CITIZEN PRINTERS HAVE 2 YEAR WARRANTY

ACCESSORIES/JOYSTICKS

1000 COLOURED LABELS£8.00
1000 TRACTOR LABELS (WHITE)£10.00
MOUSE MAT£2.75
MOUSE HOLDER.....£2.50
14" MONITOR STAND£10.00
PRINTER STAND.....£6.00
3.5" CLEANING KIT.....£2.75
CHEETAH BUG.....£12.99
PARALLEL LEAD.....£8.00
ZIPSTICK£11.50
QS PYTHON III£9.50
CHEETAH 125+£8.00
KONIX NAVIGATOR.....£12.99

DUST COVERS

A500£3.50
A600£3.50
A1200£3.50
STAR LC200£3.50
STAR LC-24 200£3.50
CITIZEN 9.....£3.50
CITIZEN 24.....£3.50
PHILIPS MKI/II.....£3.50
ATARI.....£3.50

WHY ORDER FROM BCS?

Established for over 3 years BCS is well known for the quality of its products and services.

WE HAVE THOUSANDS OF SATISFIED CUSTOMERS ACROSS THE UK.

Fast and efficient delivery service provided. All products sold carry 1 year minimum guarantee. All products UK spec only. All prices include VAT. DONT DELAY ORDER TODAY. CALL IN OR SEND CHEQUES/POSTAL ORDERS TO

BCS LTD

349 DITCHLING ROAD, BRIGHTON, EAST SUSSEX BN1 6JJ

ADD £4 P&P UNLESS STATED. ADD £10 FOR NEXT DAY DELIVERY (MON-FRI) (UK MAINLAND ONLY)

ORDER HOTLINE 0273 506269/0831 279084

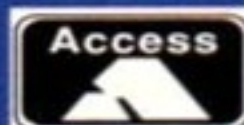

All offers subject to availability. E&OE. Prices/pack details may change without notice.

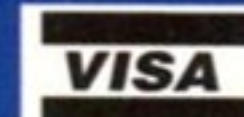

Due to currency fluctuations, all prices may change without notice - Please call for latest prices.



AMIGA POWER

1000%

GAMES



IN THE EXPLOSIVE MARCH ISSUE...

- We take an in-depth look at EA's next blockbuster - *Desert Strike*. After months of speculation, the hit Mega Drive game is finally set to wow Amiga owners.

- We blow the whistle on Dino Dini's follow-up to *Kick Off 2 - Goal*.

- Reviews - we got 'em. With reviews of *Combat Air Patrol*, *Ragnarok*, *Sleepwalker*, and the ground-breaking *Legends Of Valour*, you can trust the AMIGA POWER team to weed out the dross from the classics.

- Plus! We complete our essential A to Z guide to arcade conversions, and present the hilarious results of our *Dress Like A Lemming* compo.

- And! We present demos of *Body Blows*, and *Sleepwalker* - Ocean's game to raise money for Comic Relief.

AMIGA POWER

Attitude on the second Thursday of every month.

OFFICIALLY THE WORLD'S BEST-SELLING AMIGA GAMES MAGAZINE!



AMIGA POWER POLICY OF TRUTH

- We won't review unfinished games just to claim an exclusive.
- We don't pander to games publishers - we say what we really think.
- We only use experienced, professional reviewers.
- We won't bore you with mountains of technical-jargon-hardware tedium.
- We take games seriously, because you do too.

Trolls



Remember when no exam hall was complete without the sight of desks full of ugly – masquerading as cute – little creatures, with button eyes and a vibrant tuft of hair, who went by the name of trolls? Well, they're currently enjoying a revival, along with Abba and *Thunderbirds*.

In this game of the name, the idea is to dodge enemies in various guises while collecting a required number of baby trolls. Once you've found them, you must then find the pig stop where Pigasus, the mythical flying pig, will take you to the start of the next level. It's derivative of other platform games – but hell, if it's good, who cares?

Seven wonderful worlds

There are seven worlds, each with several levels. Each one must be completed to finish the game, but you can choose which order you play them in.

As you travel around there are various collectables – bonus points which can be picked up to increase your score, and balloons which burst on contact showering stars and prizes everywhere. You must collect these prizes before they fade. Some are merely bonus points, others are life-restoring hearts, and some have special properties which will enhance or degrade the power of your troll.

Some balloons contain letters, which can be collected to spell either 'bogus' or 'bonus', giving you access to one of two extra levels at



You'd shut your eyes too, if you were on the back of a flying pig.



Dear Mum, having a lovely time here at Slimmer's World. The aversion therapy is going well, but I keep dreaming of a chocolate rabbit and an ugly thing with purple hair. But only another four stone to go before they let me out. Love, Fat Boy.

the end of each world. Both of these levels contain loads of bonuses which may be picked up to boost your score, but failure to complete the bogus level will cause you to lose a life. If you see a white rabbit, grab it for a bonus continue.

Another important prize is a yo-yo, which will enable you to reach otherwise inaccessible platforms by swinging Tarzan-like about the screen. Firstly, though, you have to attach the yo-yo to a bit of the scenery. Problem is, there isn't really an area to aim for when firing it, so whether the yo-yo sticks or not seems to be totally random. You'll need a lot of patience otherwise you'll end up throwing your real-life trolls at the screen en masse.

While we're having a bit of a gripe, the protection sequence is another bugbear. It's one of the usual 'enter the nth word, on the nth line, on the nth page' types, but what's particularly infuriating is sometimes you are asked for a word which doesn't exist. After you've



shelled out over 20 quid for the game, you should be able to get in first time.

Absolutely fabulous

The gameplay is excellent, with outstanding graphics to make you want to come back for more. A lot of time has been spent on the wide range of enemies for each level, all of which attack in different ways. The graphics are so good, in fact, they can sometimes be distracting, so there is a tendency to be killed while you're marvelling at the sheer variety of enemies. It's an absolutely fabulous game, which considering Flair's other offering on Page 87 (*Euro Soccer*) is remarkable.

OK, it's very similar to *Zool* and *James Pond*, but everyone should have the chance to be a hero, even if you're an ugly with day-glo 'can't do anything with it' hair. Play on.

Sarah Tanser

A FEW POINTERS FOR CHERRYSODA LAND

Oxygen level – if this gets low, collect more red balloons to refill.

Shows the number of babies rescued on the current level.



Surprise the elephant so that he will remember your position.

Burst balloons and collect the prizes for oxygen and other goodies.

Number of lives remaining. Your current state of health.

Trolls Flair ■ £25.99

- There are loads of games in this genre, but the imagination used in the worlds and for the different enemies is outstanding.
- Sound effects are great, especially the sound the elephant makes when he jumps.
- Very playable, although using the yo-yo is a real pain.
- Has none of the annoying disk swaps that plague certain other platform games.



Euro Soccer

Flair Software ■ £25.99



They seem to have the likeness of Vinnie Jones down to a tee. Pity that every player, in every one of the teams, looks like Vinnie.

MANAGER: OK team, I want you to go out on to the pitch today, and give it your best shot. This time, I want you to run like realistic footballers, instead of flickering and wobbling around like you did against Spartak Rotterdam in the last game.

PLAYER 1: But guv, we have to run like that, it's the way we've been programmed.

PLAYER 2: Yeah, and seeing as you're only paying us £25.99, I think you've got a nerve asking for realism.

MANAGER: I'll have you know that £25.99's the going rate nowadays. Those Sensible players are paid the same amount, and look at the way they play.

PLAYER 1: Yeah, but they've got a decent pitch. They don't have to hang around for the scrolling to catch up with the ball - and anyway, we play a rougher game.

PLAYER 2: He's right, guv. The ball just seems to be glued to our opponents' feet - we have to take their legs away from them just to get the ball.

PLAYER 1: We do have a reputation to live up to, though. After all, each team in Europe seems to be made up of Vinnie Jones clones - including us. The only way you can tell who's who is by the colour of their kit.

PLAYER 3: Anyway, the gameplay's immaterial - at least we look good. We're drawn in realistic 3D, not like those Sensible guys who are stuck in their two-dimensional world.

MANAGER: That's just where you're wrong, Player 3. Gameplay comes first, and pretty 3D graphics should be an added bonus, not the other way around. The Amiga doesn't need another 3D footy game - they're just too ambitious - so I'm afraid we're being relegated to the lowest division.

PLAYERS 1, 2 & 3: But guv, we're...

MANAGER: Amiga Format thinks it'll be best for all of us.

PLAYERS 1, 2 & 3: But...

MANAGER: Sorry lads, but that's football. I'm as sick as a parrot.

Andy Nuttall

Verdict! 45%



Good-looking cartoon graphics such as this decorate the screens in-between matches - but they're let down by the miserable gameplay.

B-17 Flying Fortress



"I'll never forget my first time.
I was eighteen years old and still
wet behind the ears.

She guided me gently through all those
fraught, nervous days. Proud, haughty
and oblivious to all danger."

B-17. It's a flying experience
you'll never forget.

B-17 FLYING FORTRESS
Released first on IBM PC
Compatibles, followed by
Commodore Amiga
and Atari ST.

MicroProse Ltd. Unit 1
Hampton Road Industrial
Estate, Tetbury, Glos. GL8
8LD. UK. Tel 0666 504 326.

MICROPROSE
SIMULATION • SOFTWARE

CALLERS WELCOME AT OUR BRANCHES OPEN 9-5.30, MONDAY TO SATURDAY, (10-4.30 SUNDAYS) ALBANS ONLY

WARNING

Due to the exchange rate, many items in this ad will increase in price - including some CBM, HP + Philips product. At the time of going to press we are unable to confirm the extent or date of the increases, therefore, all prices must be confirmed by telephone before ordering.

Hobbyte

COMPUTING
ESTABLISHED 8 YEARS

10 MARKET PLACE ST ALBANS
HERTS AL3 5DG TEL: (0727) 56005/41396
THE GALLERY ARNDAL CENTRE LUTON
BEDS LU1 2PG TEL: (0582) 457195/411281

HOW TO USE THIS AD
For the first time ever, you can choose your own Amiga and software combination, and still benefit from the huge savings only available from package deals. Want an A500 with 1500 software? No problem! Like an A1500 without games? It's up to you! All we ask is that you choose at least 1 software pack when you order your hardware (optional on CDTV, A1200, A3000 or A4000)

WE WANT TO BEAT ALL PRICES! CALL US!!

OLD AMIGA TRADE-IN

The best trade-in allowance, extra for peripherals and accessories. Trade in your old machine for a brand new A600/ A1500/1200/3000/4000/CDTV or even PC. A limited number of refurbished A500/1500/3000s are available, complete with 3 months warranty.

A500s FROM £179
A1500s FROM £299

A600 1MB.....(mint) 219	1500 HD+Controllers.....
A600 20HD.....(mint) 219	40MB.....FROM 199
A3000s.....FROM 899	120MB.....FROM 379
CDTV.....FROM 249	Action Replay.....39
A590 20/40MB.....99/129	XT B Board.....79
Flicker Fixer 1500.....79	AT B Board.....149

OTHER ACCESSORIES - PLEASE ASK.

AMIGA 500+ £229.95
LIMITED NUMBER AVAILABLE - PHONE!

AMIGA 600

****1/2 PRICE "EPIC EXTRA" WITH ANY 600HD ADD £15**
A600 with 12 month on-site warranty, 1MB, WB 2.05, 3.5" FD + Smart Card Interface Mouse and Manuals

	ALONE	WITH 8833/CBM 1084 + ON-SITE
A600	249.00	439.00
A600 20MB HD	339.00**	519.00**
A600 40MB HD	399.00**	589.00**
A600 80MB*	469.00**	649.00**

2MB VERSION ADD £39.95
* Top quality 3rd party drives, covered by full 12 month return-to-base warranty

AMIGA 1500 inc. on-site

Full UK spec. with 1MB RAM, mouse, expansion as 2000, leads, manuals. New including Kickstart & Workbench 2.05. Hard disc configuration inc. the high performance GVP II controller card, EXPANDABLE TO 8MB.

Dual Drive	469.00	1500 SPECIALS
DD+GVP+52MB HD	732.00	1/2 PRICE 1500 S/W PACK EXTRA Only with 1500, 1500 Pack Extra at only £24.99
DD+GVP+80MB HD	799.00	1500 HD + ON-SITE, 8833/1084S, CITIZEN 200 24 pin col printer, 1500 Extra software pack, Starter Pack + AmigaVision
DD+GVP+120MB HD	872.00	52MB.....£1149.00 120MB.....£1329.00
With 8833/1084S	ADD 179.99	
With 7CM + M/W FF	ADD 379.99	
Per extra 2MB fitted to GVP	ADD £60.00	
Also with Kickstart 1.3 + ROM Sharer	ADD £39.90	
Also with Citizen 200 24 pin Col Printer + Starter Pack	ADD £199.00	

AMIGA 3000

12 MONTH ON-SITE MAINTENANCE
Latest version, 68030 25MHz, 3.5" 880K FD + spare drive bay (or 4 spare bays on Tower), 512K 32 bit ROM, 4 Zorro III, slots with 2PC AT slots (or 1 CPU, 7 Zorro III, 2 PC AT on Tower), hard drive and memory as below:

DESKTOP	52MB	120MB
1MB video + 1MB Fast Ram	1199	1289
2MB video + 4MB Fast Ram	1349	1439
2MB video + 8MB Fast Ram	1489	1579

WITH FREE AMIGA VISION
With extra 4MB Fast RAM (fitted if required) ADD £169.99
With Philips SVGA 28dpi inc. tilt & swivel ADD £259.00

AMIGA 1200

1200 2MB SD.....	369	1200 2MB 80MB HD.....	595
1200 2MB 20MB HD.....	499	1200 2MB 120MB HD.....	735
1200 2MB 40MB HD.....	549	1200 6MB 80MB HD +68881.	
1200 2MB 60MB HD.....	569		875

Install disc and full 12 months return-to-base warranty on all HD models. With Zool, Striker, Pinball Dreams and Transwrite ADD £19.99
OR SEE NEW AGA GG PACK BELOW

CDTV

1MB, with Disc Caddy, Welcome CD + tutorial + remote control unit. AS ABOVE WITH MATCHING DRIVE KEYBOARD, MOUSE + WB 1.3

As above	£349*	£435
monitor + remote control		
Extra RAM	EPOA	

* Plus Hutchinsons Encyclopaedia + Lemmings
See below/across for software packs

NEW PRICES!

AMIGA 4000 MULTIMEDIA AMIGA

New AGA Chip Set + blistering 68040 processor, 256,000 colours from 16.6 million, scan doubling for flicker free display, 25 MHz, Mouse, Amiga 3.5"/1.76 MB 3.5" drive Plus Cross DOS for transfer of files between Amiga DOS +MS DOS, 2 rear + 2 front 3.5" bays, 1x 5.25" bay, Hard Drive as below, Amiga DOA 3.0 system and utilities, Gold Service Warranty

FULL 68040	ALONE	
120MB HD 2 + 4MB	£2089 inc. VAT	TRADE IN AVAILABLE
120MB HD 2 + 8MB	£2259 inc. VAT	
240MB HD 2 + 8MB	£2399 inc. VAT	

With Kaga M/Sync SVGA low radiation high-res 28 dot pitch col. monitor inc tilt and swivel, all 4000 modes ADD £400

THE HOT LIST CURRENT TITLES VARY - INCLUDES:

Paperboy II	Hunt for Red October
Colossus Chess	Blinky's Scary School (under 12)
Challenge Golf	Battleships
Neighbours	Licence to Kill - Bond Game
Frankenstein	Silkworm Helicopter jeep mission 93% CU
Edd the Duck (under 12)	Continental Circus - 8 Int race circuits 92% AA
Master Blazer - 3D sports	Xenon - C+VG Game of the Month
Onslaught - Format G 90%	Thunderstrike - Fighter Flight Sim

+ LOTS MORE - AT LEAST 25 TITLES TO CHOOSE FROM!

AGA GG PACK (GRAPHICS + GAMES) FOR A1200, 4000 ETC.

	VALUE/RRP
• Personal Point AGA - Top reviews, impressive DP IV clone with additional features inc. image processing, paints in any screen mode	69.99
• Your choice of - Zool AGA or Sensible Soccer AGA	34.99
• 5 'Hot List' games (AGA compatible) individually boxed	174.95
• Microswitched Joystick	9.99
• Mouse Mat + Dust Cover	9.98
• 10 Blank Discs + 80 capacity lockable disc box	16.98
• Virus Killer	4.99
TOTAL VALUE	321.87
WITH AMIGA/CDTV SEPARATELY	89.99
	109.99

THE HOTTEST LOT PACK

• All as Starter Pack	VALUE/RRP
PLUS:	203.90
• Another 10 GREAT individually packaged games, BETTER THAN THE REST previous RRP's up to 39.99 each, phone to choose from HOT LIST, or leave it to us! Children's games available.	269.82
• 80 Prog. Hobbyte PD Greats Pack II - Includes top games like Battlearcs, Star Trek, Computer Conflict, Megaball, dozens of arcade classics, board classics and 'shoot-em-ups', DPaint clip art, Utilities, Word Processor, Spreadsheet, Database + Desktop Publisher and the ultimate virus killers - a must for every new Amiga owner!	39.99
TOTAL VALUE	513.71
WITH AMIGA SEPARATELY	49.99
SPECIAL: ALSO 10 extra 'Hot List' games	ADD 25.00
	69.99

WWW EXTRA PACK

	VALUE/RRP
• WWW games: Silly Putty	25.99
Formula 1 Grand Prix	25.99
Pushover	25.99
• DPaint III with animation	79.99
• 700 clip art pics/graphics for DPaint III	9.99
• 3 disc Home Pack incl. W Processor, Dbase, Spreadsheet	9.99
• Virus Killer	4.99
TOTAL VALUE	182.93
WITH AMIGA/CDTV SEPARATELY	49.99
	59.99

EPIC PACK EXTRA

	Needs 1MB and Hard Drive	VALUE/RRP
• Epic Pack: Trivial Pursuit, language Lab, Amiga text		29.99
Epic, Rome, Myth		77.97
• DPaint III with animation		79.99
• 700 clip art pics/graphics for DPaint III		9.99
• 3 disc Home Pack incl. W Processor, Dbase, Spreadsheet		9.99
• Virus Killer		4.99
TOTAL VALUE		212.92
WITH AMIGA/CDTV SEPARATELY		29.99
		39.99

NO OTHER DEALER CAN BEAT OUR CREDENTIALS

- 8+ years experience in Commodore product and here to stay
- Commodore trained staff are friendly and helpful and are parents, multimedia, educational, games, programming or technical specialists (usually more than one!)
- Open 9-6 pm Monday to Saturday and 10.00 am to 4.30 pm Sundays for convenient shopping.
- Callers welcome for advice and demonstration at our 1600+ sq ft High St, Town Centre branches
- Same day despatch for most orders received by 5.30 pm; express am and Saturday services available
- Hardware carefully handled and delivered safely and reliably by caged, insured, top name courier service
- Pre-despatch testing on Amiga systems
- Free 30 day, next day courier collection and delivery of NEW replacement.(except product with on-site maintenance)
- Hotline support and in-house engineers
- Upgrade and trade in offers to keep you up to date
- Exceptional after sales service
- BFPO and Export welcome

NOT JUST ANOTHER MAIL ORDER COMPANY

For years a major player in Amiga Mail Order, Hobbyte also boast extensive expertise and experience in specification and support of multi-machine and specialist systems. Hobbyte have been recommended and trained by Commodore and successfully won major orders and support contracts from London Boroughs, MOD, educational establishments etc. We are pleased to be placed on tender lists. This expertise is available to all our customers.

STARTER PACK

	MAX VALUE/RRP
• Microswitched Joystick	9.99
• 80 cap. lockable disc box PLUS 10 blank discs	16.98
• 4 great boxed games - See HOT LIST	159.96
Phone for current choice OR DPaint III +700 Clip Art Pics/graphics	
• Mouse Mat and Dust Cover	9.98
• 16 Days Free Hotel Accommodation in UK, Ireland or France - you pay only for meals	
TOTAL VALUE	196.91
WITH AMIGA/CDTV SEPARATELY	19.99
	29.99

PROFESSIONAL FAMILY PACK (1MB REQUIRED)

	VALUE/RRP
• Cartoon Classics Games: Lemmings OR Zool	25.99
The Simpsons Striker	24.99
Captain Planet Pinball Dream	25.99
• Deluxe Paint III with animation + 700 Clip Art pics	89.99
• Gold disc Office - WP + UK 'guess spelling' checker, spreadsheet, database, graphics + desktop publishing	169.99
• Edd the Duck	29.99
OR Round the Bend OR Digita Home Accounts	
• Virus Killer Disk	4.99
• 80 Prog. Hobbyte PD Greats Pack - see 'Hottest Lot Pack'	39.99
• 4 disc DP pack inc. Fonts, Clip Art and Disc Tutor	9.99
• Hobbyte Primary (specify) or Secondary Educational Pack	19.99
• 10 Blank Discs + 80 Capacity lockable disc box	26.98
• Mouse Mat + Dust Cover and Joystick	19.97
TOTAL VALUE	488.85
WITH AMIGA/CDTV SEPARATELY	79.99
SEPARATELY	99.99

SPECIAL: Also with Citizen 200 24 PIN Colour Printer and Starter Pack ADD 199.00

ABSOLUTE BEGINNERS PACK 3-13 YEARS

	VALUE/RRP
• Your choice from:	
- Fun School 2, 3 or 4 (for 3-9 yrs - specify age, 9 diff. versions available) Up to 6 stunning UK educational games in each package, with beautiful pictures, exciting animation + music that helps to develop numbers, word + other skills. Up to 6 levels of difficulty. Conforms with National Curriculum.	25.99
- Merlin's Maths (for 7-11 yrs) from the award winning 'Fun School' stable, 6 engrossing games to teach essential maths skills, in a way children will love.	
- Spelling Fair (for 7-13 yrs) all the fun of the fair on 6 levels makes learning spelling addictive and fun. Includes 6 games plus 3000 word dictionary + special selection of words for needs of dyslexic children + parents can create own dictionary of words requiring special attention.	
• Edd the Duck (7 yrs) OR Elf (7+ yrs) OR Round the Bend	25.99
• Hobbyte Primary (specify) Educational Pack, featuring up to 12 'Learn while you play' games	19.99
• Hobbyte 30 Easy Children's Games, 10 pack disc including Train Set and other top entertaining PD titles	19.99
• SpritzPaint + 700 Clip Art pics	89.99
inc. children, Fairytale + Legend characters, Sport, Cartoons etc.	
• Joystick + 10 blank discs	15.98
TOTAL VALUE	197.92
WITH AMIGA/CDTV SEPARATELY	39.99
SEPARATELY	59.99
SPECIAL: Each extra title from first selection add just	15.00

TRAMPY'S, THOMAS'S OR NODDY'S PACK 2-8 YEARS

AT LEAST 57 EDUCATIONAL/FUN FILLED GAMES!

	MAX VALUE/RRP
• The Shoe People - 6 colourful and entertaining games featuring Trampy and friends to encourage early number reading and pre-reading skills. With Shoe People music	29.99
OR Thomas the Tank Engine's Fun with Words - 6 separate easy to use learning programmes with animation and sound.	
OR Noddy's Playtime (to 7 years) - 8 magical learning games at 3 levels, PLUS Junior Art package inc. Colouring, electronic 'Fuzzy Felt', FREE Toy Town map, Keyboard overlay and wobbler.	
• Shapes and Colours - Bobby the Clown entertains and lays down the foundation for maths and writing in 6 colourful animated games.	
OR Fun School 2 (for 3-9 years - specify age)	9.99
• Fun School 3 or 4 - the 'Fun School' suite have won just about every award going. 5 or 6 wonderful animated games.	24.99
OR Picture Book: 4 colourful and amusing games from ex 'Fun School' design manager will delight young children	
• SpritzPaint + 700 Clip Art pics inc. children, Fairytale + Legend characters, Sport, Cartoons,	89.99
• Hobbyte Primary Educational PD Pack, containing 10 fun while you learn games	19.99
• Hobbyte 30 Easy Children's Games Pack	19.99
• 10 Blank Discs, Joystick, Mouse Mat	26.96
TOTAL VALUE	221.90
WITH AMIGA/CDTV SEPARATELY	59.99
SEPARATELY	79.99
SPECIAL: Each extra title from first selection add just	18.99

LIMITED ZOO GCSE 11-15 YEARS

+ SCHOOL PACK

• Zool - Number 1 Chartbuster	25.99
• Striker - 94% CU Amiga	25.99
• Pinball Dreams - 94% AUI	25.99
• Transwrite UK WP + Spellchecker	49.99
• ADI French, Maths or English (11-15, specify age)	
• ADI the lovable extra terrestrial gifted teacher, guides you through National Curriculum. Ideally compliments school work. From the award winning Fun School team	25.99
OR ADI Junior (under 5's)	
OR 6 HOT LIST Games	209.94
• Hobbyte 80 Programme PD Greats Pack - 'See Hottest Lot'	39.99
• Hobbyte Secondary Educational Pack	19.99
• Microswitched quality joystick	9.99
TOTAL VALUE	407.87
WITH AMIGA/CDTV SEPARATELY	49.99
SEPARATELY	69.99

AMIGA 24 BIT SYSTEM - £BEST! WE SPECIALISE

- Extra RAM • Accelerator
- 24 bit colour card • 24 bit colour real time digitizer
- 24 bit 3D Art + animation s/w
- Fitting and Free 1/2 day customised training

TELEPHONE JP

1500 PACK EXTRA (ALSO FOR A500, A500+, A600 CDTV, 3000)

	VALUE/RRP
• The Works Platinum, word processor, spreadsheet, database or Office - see Prof. Family Pack	169.95
• Deluxe Paint III with animation	79.99
• Get the most out of your Amiga book	9.95
• 80 Prog. Hobbyte PD Greats Pack - see 'Hottest Lot Pack'	39.99
• 4 disc 700 Clip Art pics/graphics for DPaint III	9.99
• Puznic, Toki, Elf	
OR Zool, Striker, Pinball	74.97
• Digita Home Accounts	29.99
TOTAL VALUE	429.82
WITH AMIGA/CDTV SEPARATELY	49.99
SEPARATELY	69.99

ACCESSORIES

A500 Deluxe control centre	44.99	Alien/Batman/T2 Joystick	10.99
A600 Control Centre	29.90	Bug Joystick	11.99
A520 Modulator	29.99	CDTV Keyboard	54.99

MODEMS

Amstrad SM 2400 Modem	118.99
Supra Fax 2400 + 5 year warranty	78.95

FLOPPY DRIVES

Zydec 3.5 external drive, daisychain + on/off	48.95
Cumana CAX 354 3.5 external drive, beige	52.99
CDTV external 3.5 drive, black + 10 blank discs	49.99
PC 880B with anti click + Blitz back up and virus protector	65.00
PC 880B as above, Cyclone compatible	78.99
Dual drive as PC 880B	125.00
Replacement A500 drive	34.95

MONITORS/ACCESSORIES

CBM 1084ST including tilt + swivel + 2 games	199.95
CBM 1084SD monitor + leads + 2 great 'Hot List' games	189.00
Philips UK 8833 MKII mon. + leads + Turbo Challenge + on-site	219.99
Tilt + swivel stand for Philips 8833	12.99
CBM 1960 High res monitor	359.99
KAGA 14" Multi Sync for 1200/4000	429.00
KAGA 20" Multi Sync for 1200/4000	1549.00
Philips 7CM Hi-res SVGA .28dp inc. tilt & swivel	259.99
NEC 4FG Multi-Sync	544.99
Microway Flicker Fixer	124.99
ICD Flicker Free Video 2-A500	197.90
Elec. Des Fix	196.99

SCANNERS & DIGITISERS

Epson GT 6000, 600dpi 24 bit A4	789.00
Epson GT 8000, 800dpi 24 bit A4	1192.99
Power Hand Scanner, 400 dpi, 64 Greyscale, Powerscan software	88.99
Power Hand Scanner as above, V3 for 1200/4000	104.99
Power Colour Hand Scanner	219.49
Sharp JX 100 A6 Scanner + scanlab s/w up to 18 bit	469.99
Sharp JX 320A6 Scanner + s/w up to 24 bit	898.99
Vidi Amiga 12	74.99
Summa Sketch II A4 Tablet Digitiser	319.99
Summa Sketch II A3 Tablet Digitiser	529.99

EMULATION

KCS Powerboard	146.50	G Gate 386sx 25MHz	438.99
KCS Powerboard with DOS	188.49	G Gate 486SX	795.99
KCS adaptor	59.99	GVP 286 for GVP/II + 530	216.99
AT Bridgeboard for 1500	199.00	AT Once	214.99
386 Bridgeboard for 1500	299.99	GVP 40/4 for 1500	945.99

DISCS

10 Blank DS/DD discs in box	4.99	50 Blank DS/DD discs	17.99
10 Blank DS/HD discs	6.99	50 Blank DS/HD discs	27.99

ACCELERATORS/HDA500/600

A530 1MB 120MB	728.99	A590 20MB	259.99
A530 1MB 240MB	908.99	A570 for 2.04 1MB 500	309.99
A530 68882	203.99	20MB HD upgrade 600/1200	149.00
GVP HD8 42MB	339.99	60MB HD upgrade 600/1200	199.00
GVP HD8 85MB	439.99	80MB HD upgrade 600/1200	229.00
GVP HD8 120MB	499.99	120MB HD upgrade 600/1200	359.00
IVS Trumpcard 42MB HD	279.99	Microbotics VXL30 25MHz	219.99
Extra 2MB fitted to above	62.99	2MB Burst RAM for above	179.99

ACCELERATORS/HD A1500/2000/3000

GVP Series II 40MB	309.99	G Force 030 50MHZ 4MB	1099.99
GVP Series II 80MB	379.99	G Force 040 33MHZ 2MB	POA
GVP Series II 120MB	409.99	Prog Zeus 040 28MHZ 4MB	1739.99
GVP Series II 420MB	1033.99	Prog Mercury 040 28MHZ (3000)	1349.99
G Force 030 25MHZ 1MB	543.99	Sysquest removable HD 88MB	549.95
G Force 030 40MHZ 4MB	783.99	Extra 2MB fitted to any above	62.99

EXPANSION

A500 512k Ram Exp+Clock	19.90	A1200 32 bit 2MB exp	POA
A500+ 1MB exp	28.99	A1200 32 bit 4MB+68881	279.00
A500+ 2MB, exp. to 8MB	149.99	A1200 32 bit 4MB+68882	349.00
CBM 2.04 upgrade kit	74.99	A1200 32 bit 8MB+68882	549.00
A600 1MB exp (chip)	39.99	A500 Rom Sharer 1.3	39.95
A600/1200 2MB exp (fast)	117.99	A500 Rom Sharer 2.04	38.95
A600/1200 4MB exp (fast)	179.99	A600 Rom Sharer + 1.3	49.95

Chip fitting and board upgrade available, by our qualified engineers or DIY kit POA

GENLOCKS

CBM Rendale 8802 (500/600/1200 compatible)	139.99	Video Plot v330	994.94
CBM Rendale 8802 SVHS	529.99	Elec. Des YC Genlock	496.49
Elec. Des Pal Genlock	329.99		

2YR WARRANTY PRINTERS WITH CITIZEN

ALONE	WITH STARTER PACK	ALONE	WITH STARTER PACK
Citizen 120+D	110.99	HP Deskjet 500	334.99
Star LC20	113.49	HP Deskjet col ^S	424.99
Star LC 100 9 pin col	146.49	HP Deskjet 550C	544.99
Star LC200 col	164.49	HP Deskjet Portable ^S	339.99
Citizen Swift 9"	163.49	HP Paintjet ^S	639.99
Star LC 24-20	173.49	BJ10ex Bubblejet port.	204.99
Star LC 24-100 24 pin	163.49	BJ 20	304.99
Star LC 24-200	197.25	BJ 200	329.99
Star LC 24-200 col	236.49	BJ 330 A3	469.99
Citizen 124D	176.99	BJ 300	338.99
Epson LQ 100	189.99	Star SJ 48	205.99
Citizen S200 24"	179.99	OKI 400 laser	399.99
Citizen S200 24 col*	194.99	OKI 410 +	649.99
Citizen S240 24 col*	249.99	HP Laserjet 11P +	649.99
Citizen S24x col*	296.99	QMS Ink Jet col A4	4999.95

*Turbo Print Pro driver/util s/w highly recommended ADD £39.95

STARTER PACK: 500 Sheets A4 or continuous paper, Amiga to printer lead, Universal Printer Stand & Driver * with Print Manager

24 BIT

A Video 24 with TV Paint for 500	588.90	Image Master	1069.00
Art Dept. Pro 2.1A	129.99	Opal Vision 24 bit board + Opal Paint, Opal DCTV	
Deluxe Paint III	403.99	Presents, Karate 24 bit s/w	629.99
Firecracker	POA	Rembrandt 24 bit board	2489.99
GVP IV + VIU-S	1389.99	V Lab 24 bit real time digitiser	289.99
GVP IV + VIU-CT	1759.99	V Lab 1200/4000	324.99
Harlequin 4000 24 bit card	POA		

SOFTWARE

GRAPHICS/CAD		Pro Video Plus	137.99	Final Copy II	66.99
AmigaVision	47.50	TV Show Pro	51.39	Kind Words III	35.99
Deluxe Paint IV	53.99	TV Text Pro	68.99	Maxiplan Plus v4	34.50
Deluxe Paint AGA	POA	Video Director	106.99	Mini Office	43.99
Expert 4D Junior	36.99	EDUCATIONAL		Pagestream 2.2	143.99
Expert Draw	48.99	Any Fun School 3 or 4	414.99	Pagesetter II	42.49
Imagine v2	109.49	Any ADI	17.50	Pen Pal 1.4	52.50
Prodraw 4 AGA	POA	Spelling Fair	16.99	Personal Finance	
Real 3D Beg 1.4	83.99	Paint & Create	16.99	Manager Plus	31.99
Real 3D		Merlin's Maths	16.99	Pro. Page 4 AGA	POA
Turbo Pro 1.4	229.50	See also software packs		Saxon Publisher	177.95
Scala 500	68.99	UTILITIES/ LANGUAGES		Superbase Pro 4	148.99
Scala MM200	434.99	AMAX II Plus	249.99	Wordsworth V2	73.99
Scala Pro 1.13	173.50	Amos 3D	21.49	Works Platinum	43.99
Sculpt Anim. 4D	198.99	Amos the Creator	30.95		
Spectra Colour	57.99	Amos Compiler	19.49	MUSIC	
X CAD 2000	89.50	Amos Prof.	44.50	AD 10 12 Studio 16	
X CAD 3000	205.99	Easy Amos	22.49	Sampler	349.95
Essence	34.99	Cross Dos v5	22.75	Audio Engineer	
Aladin 4D	213.99	Disk Master II	43.75	Plus 2 Sampler	188.99
VIDEO PRODUCTION/TITLING		GFA Basic	17.99	Audio Master 4	44.49
Adorage	59.49	Lattice C 6	219.99	Bars & Pipes	
AmigaVision	39.90	Quarter back	30.50	Pro 1.0E	162.99
Broadcast		Quarter back Tools	44.99	GVP Digital	
Titler II	148.99	Xcopy Pro	34.95	Sound Studio	48.99
Deluxe Photolab	51.49	APPLICATION		Midi Interface	19.95
Morph+	129.99	Arena Accounts	89.50	Rombo Megamix	23.99
		Excellence 3	88.99		

ORDERING:

TELESALES NO: (0727) 56005

Some day despatch for Switch or credit card orders placed before 5pm subject to availability. Alternatively send cheque, postal order, bankers draft or official order (PLCs, Education and Government bodies only) to: Dept. AF, Hobbyte Computer Centre, 10 Market Place, St. Albans, Herts AL3 5DG. Please allow 7 working days for cheque clearance. Subject to availability, despatch is normally within 24 hours of receipt of cleared payment. Prices are correct at time of going to press, however, we are sometimes forced to change them, either up or down. Please check before ordering. Additional services and different packages may be offered in our showrooms, and prices may vary from Mail Order prices. Personal callers are asked to quote this ad to ensure Mail Order packages are offered.

DELIVERY CHARGES:

Small consumables & software items	UK MAINLAND (NOT HIGHLANDS)
Other items, except lasers	Despatched by post, please check charges when ordering
Offshore and Highlands	Next day courier service, £10 per box
	Please enquire
IN ADDITION WE OFFER THE FOLLOWING EXPRESS SERVICES:	
Saturday deliveries	Normal rate plus £15 + VAT per box
Am next day	Normal rate plus £8 + VAT per box

NO DEPOSIT CREDIT FACILITIES

Credit terms at 34.8% APR (variable) can be arranged for purchases over £150, subject to status. Competitive leasing schemes are

Take a trip to the weird and wonderful world of Mittedorf; a town full of villains, dodgy landladies, pigmen and the lovely Dunghead and Lionel – and these are just your friends! Read on, oh valiant one...

What we have here isn't so much a game as a visit. The town of Mittedorf is a thriving little metropolis with a weird and wonderful bunch of citizens. In order to survive for longer than an evening, you need to become familiar with the workings of the society and its people.

On the face of it the game looks like a cross between a Dungeons & Dragons game and a graphic adventure. There are set tasks which you need to complete in order to rise up through society; how far you go is up to you. Similarly, you can ignore some of the quests and spend time getting to know the people and places. It's one hell of a flexible environment. Anyway, come with me now to a valiant land...

Satyr's Day, 14 Juine

Dear Diary,
I'm finally here! I arrived in Mittedorf this bright and breezy Satyr's Day. Upon being dropped off by Stinky the Pigman, I bade farewell to his two lovely sows (Juniper and Penelope) and wandered in through the huge city gate. I was bewildered by the hustle and bustle around me, but once I got my bearings I decided to find somewhere to stay.

After asking a wizzened old hag who was selling potatoes near the gatehouse, I found my way to the Custom House. I wandered up to the main desk and was greeted by a custom's officer called Norris, who offered to buy any used goods from me. Then he pulled his arm out of its sling, got out of his wheelchair, lifted his eye patch and winked at me.

Once we'd sorted out that I didn't want to part with any of my major organs, he directed me towards the notice board. Apart from lots of curious cards saying things like 'Lusty Lorna will peddle your bike (come to the Old Frog Inn)', and 'Mammary Annie will dangle your blues away (visit the Scrott 'n' Stew Pub)', I spotted a message from Sven, my cousin, who I'd come all this way to find.

Moon Day, 16 Juine

So much has happened since I arrived that I haven't had much chance to sleep, let alone write down my experiences. The town is enormous, and packed to bursting with every kind of enterprise. There are taverns, hostels, shops, guilds, temples and prisons along with very weird places such as The Hag's Pit and Charnal House.



Come to sunny Mittedorf, where the guards are fascists, the beer is fatal and the fair maidens turn their back on you unless you nip into the jewellers and buy them a suitably expensive ring.

Legends of Valour



You start off the game in the middle of the city, just outside the town gates. The custom house is on the right.



Not a terribly wise idea that. I mean, hitting an officer of the law is a sure-fire way to end up dead or a werewolf.



Dodgy landlords are a feature of life in the city. This one has rumbled the fact that you're a student already.

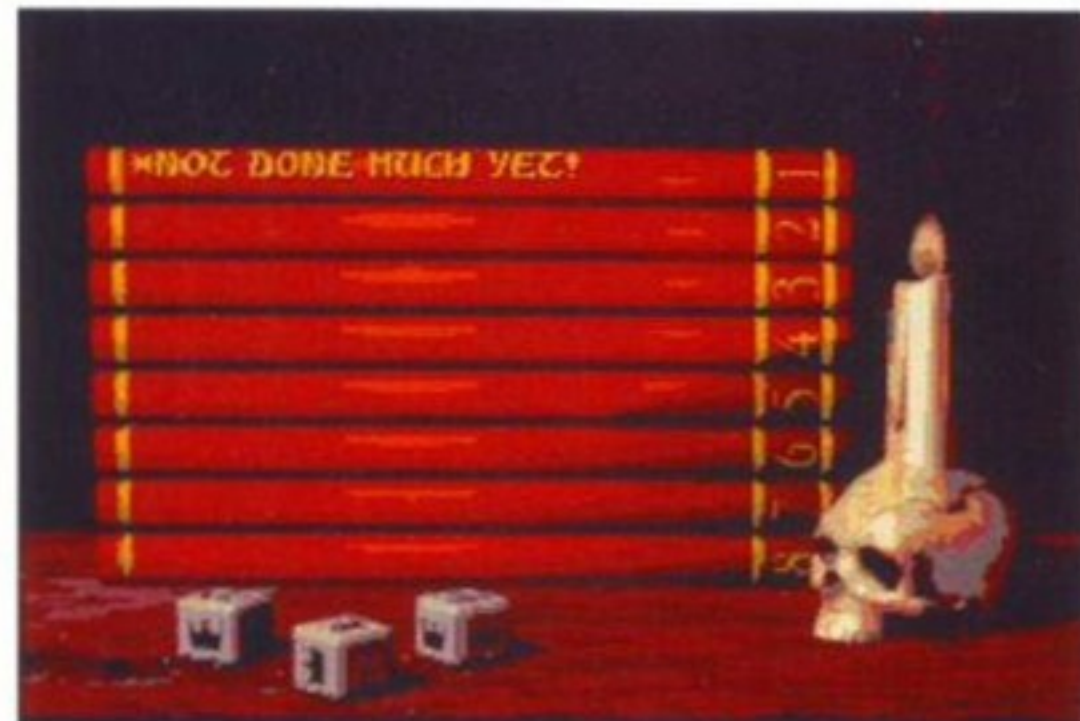

You can have up to eight games on the go at any one time. We strongly advise you to save regularly.

THE ROUGH GUIDE TO MITTLEDORFIAN WARFARE

Having found my bearings, the first thing I did was find somewhere to sleep. The Travellers Inn hostel seemed a suitable place to rest my bones. The management (a lovely landlady called Loopy Lindy Loo) arranged to have a basket placed in my room, into which I could place all my valuables for safe-keeping. You see, the streets are full of bandits and robbers, and the last thing you want is some villain stealing your last pot of beetroot pigment. Anyway, after having a bit of a kip I decided to go and look for Sven.

My journey was slow because I didn't have a clue where I was going. The map I brought with me only had a few places of interest marked, and the citizens looked at me in the oddest way when I asked them for directions to the Hanged Man pub. One chap called me a "festering lump of cockroach excrement" and hit me. Thankfully those boxing lessons Magnus the Poacher arranged with Sad Ernest came in handy, and I gave the sack-clothed mugger a right royal kicking. And then I robbed him. Well he started it, didn't he? Don't look at me like that, Diary.

Woden's Day, 12 Julye

You'll be pleased to know that the stain came out, Diary, so there was no need for the 'fish lips and fried toejam' balm which Morgana got off Dumpdoodle. Today is the brotherhood's AGM at the Guild of Thieves and I'm up for promotion from graverobber to thief. My swag bag needs patching up because the Godfather and all the other beggars, pickpockets, graverobbers and thieves will be there. What's more, the money's better, which is just as well as Lindy Loo wants her rent.

Once I'm invested as a thief, I have to nip across town to the Brotherhood of Loki. Apparently, some other guild has been on our patch and we've got to work out a battle plan to teach them a lesson. Thrushbreath reckons that we should steal their divine statue to teach them a lesson, but the Worshipful High Priest reckoned that would only tempt them to nick all our prize petunias again.

Day of the Sun, 28 October

Blimey, what a night. The boys and myself went out on a tavern crawl last night and ended up in The Snakes. Dunghead and Lionel started betting on the cockroaches and before they knew it they were 50 groats up. What

“Legends of Valour is a cross between a Dungeons & Dragons game and a graphic adventure”

luck eh? Of course, I'd had a few meads by then and so I had a go myself. Unfortunately I picked the only three-legged cockroach in the race and he limped home in last place.

On the way back from the tavern, nothing much happened: Lionel got jumped by a werewolf, Dunghead got mugged and I ended up in the slammer for vagrancy. All in all it was an ordinary Satyr's Day night out. Anyway, I've got to nip down to the Temple of Set for a spot of worshipping today, besides which, there's this gorgeous hand-maiden of Set who works in the kitchens. Oh, and guess what, I bumped into Sven in the Witches Meadow, apparently he's been working with... *ad infinitum*.



Don't you meet the oddest people? Wander into the right shop and you can meet... ermm... well me actually. I run a lovely shop with a good line in pigments, but don't visit my twin brother's shop across town.

Resolution

Graphically *Legends of Valour* looks sumptuous. It uses a technique called texture mapping which enables you to walk right up to people or buildings and examine them in detail; you can even look in through windows to see if there's anything interesting inside, or stand inside a building, looking out of the window and watching people strolling about. The actual interface is intuitive and well designed, so that moving around the town and interacting with it is painless.

There are plenty of nice touches, particularly the vein of Pythonesque humour which runs throughout. For instance, in order to attract someone's attention you literally shout 'Hey' at them. If you've met the person before then they'll remember you, which is bad news if you mugged them the last time you met.

DCD have got around the lasting-interest problem by leaving Mittedorf as an open environment which you can dip into as and when you please – the game isn't over once you've found Sven and risen to the top of each of the guilds.

Having said all that, the graphics take up a hell of a lot of processing time, and so while there are ways of speeding things up (such as reducing the screen size), the going does get a bit heavy on an A500. As with most games these days, there's also a lot of disk accessing, so if that kind of thing really grates on you, then either buy a hard drive or forget *Legends of Valour*. All of which would be a bit of a shame, because this is both an innovative and interesting game which has a very wide appeal. Now where did I leave that sexy-looking, sack-cloth tuxedo?

Andy 'Dungbeetle' Hutchinson ☺



This is actually a very wise idea. However, the insurance this guy's flogging is a bit different. It reincarnates you.



If you get bored you can always insult someone. Not the kind of thing you hear at Highbury though is it?

91%

Legends of Valour
US Gold/DCD ■ £39.99

- Superb looking game with a really flexible 3D environment.
- Plenty to do and see, even after all the tasks have been completed.
- Utterly stark-staring mad.
- Made in the old Chubb building in Wolverhampton.
- Whole little world unto itself. Cloud cuckoo-land incarnate.

POWER TO SEE THE PROBLEM AND SUPPLY THE SOLUTION

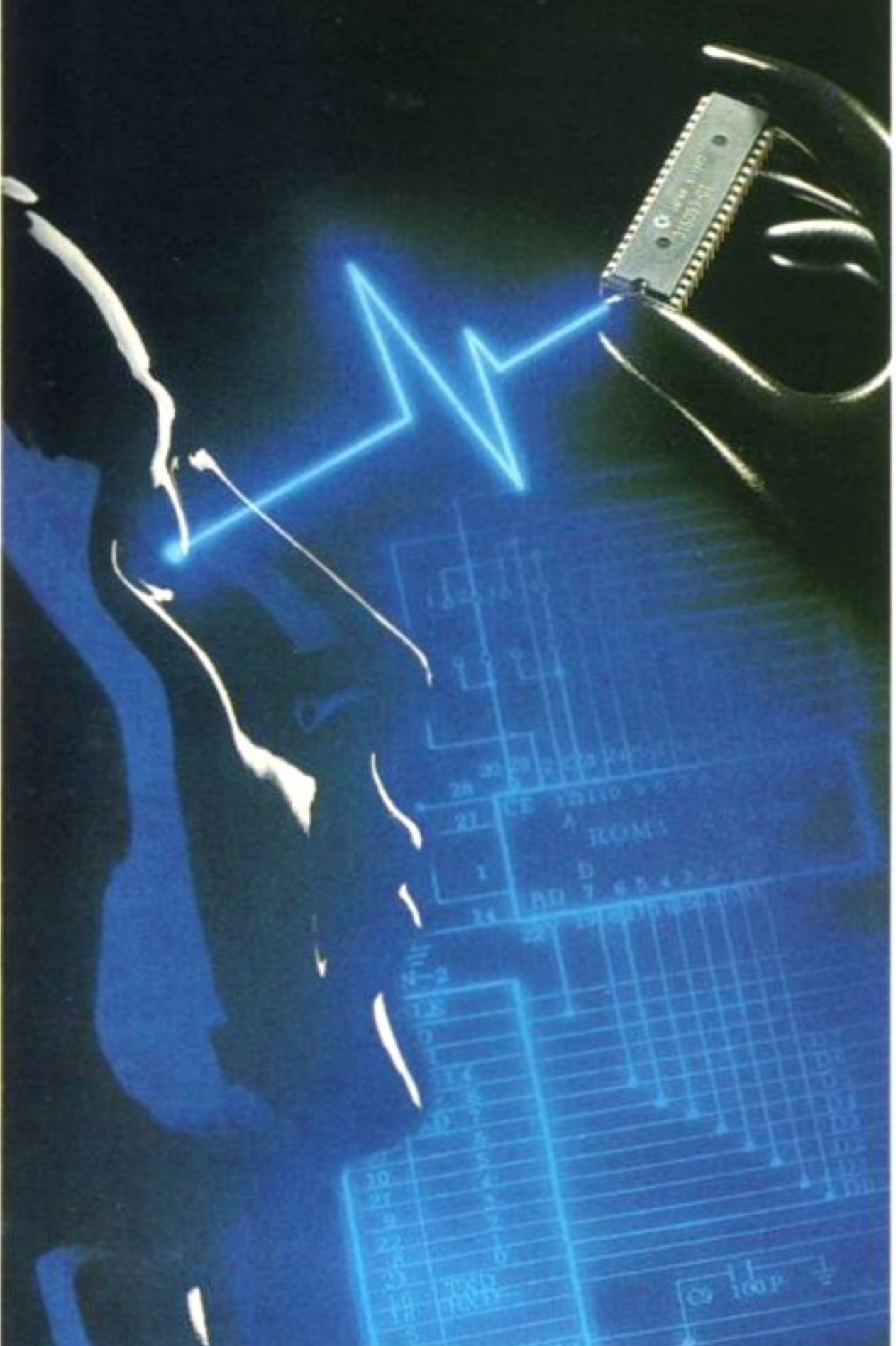

ACS Electronics is an established service centre for AMIGA equipment. We specialise only in the repair and maintenance of computer hardware. Dedicated to a programme of quality customer care, our continual expansion enables us to offer you, our customer, a service that we believe to be second to none. Our service includes;

FAST EFFICIENT SERVICE,
most repairs are carried out within **ONE DAY**

QUOTATIONS RATHER THAN FIXED PRICES,
fairer to you, and in practice faster to process. Each repair is quoted for separately, **no fixed charges full of exclusions, or hidden extras.**

REPAIRS FROM £23

FREE CARRIER SERVICE with insurance,
FREE diagnostic inspection, free 90 day warranty, FREE soak test, FREE software.
No hidden charges.

OPTIONAL EXTENDED WARRANTY
at competitive rates.

Experienced and qualified engineering and support staff.

5% DISCOUNT
available to students and OAP's.

UNBELIEVEABLE UPGRADE FITTED PRICE OF £15 INCLUSIVE

Trade and Education welcome. Dealer pack available on request.



COMPUTER MAINTENANCE, UPGRADES AND REPAIRS
B.E.C. ELDON STREET, SOUTH SHIELDS, TYNE & WEAR, NE33 5JE
TEL. (091) 4554300 FAX. (091) 455 1847

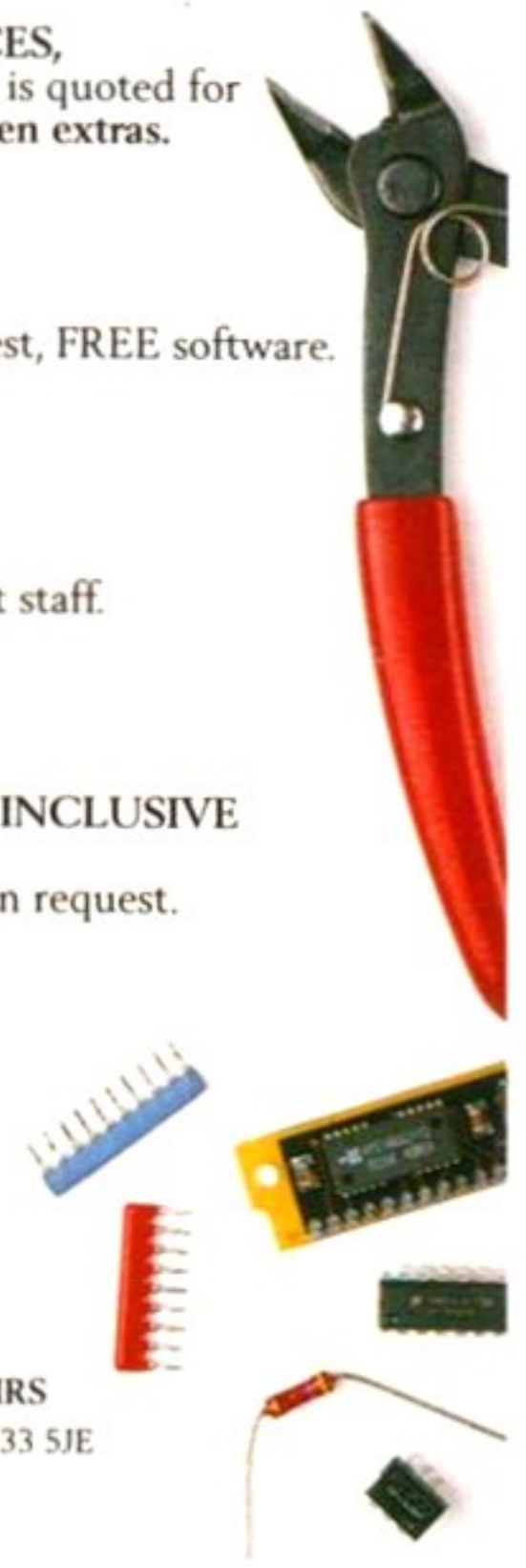

FREEWHEEL® PERFECT CONTROL FOR ULTIMATE REALISM

Just imagine, sitting in your favourite armchair and driving MicroProse Grand Prix with a replica racing car steering wheel. Freewheel® has fire buttons on its inside rim, just like the real thing. Freewheel is described as a Virtual Steering Wheel because you sit back in your seat in a comfortable position and simply hold the wheel giving you 140° of analog movement, when turned left or right. Tilt forwards to accelerate and backwards to brake, the amount of acceleration and braking depends on how much you tilt.

Freewheel® Analog was designed with MicroProse Grand Prix in mind and lets you use your real driving skills to win races and as such is the ultimate accessory for budding 'Nigels'

£39.95 RING FOR SPECIAL OFFER

R. C. Simulations

UNIT 16 BEEHIVE TRADING ESTATE, CREWS HOLE ROAD, ST GEORGE, BRISTOL BS5 8AY
TEL: (0272) 550900 FAX: (0272) 411052

If information only required, please enclose see quoting interest
Prices exclude p.p. Please add £1.95
Please allow up to 21 days for delivery

Access

Educational Software

The Connoisseur's Choice

If you are looking for software to help with the National Curriculum, then look no further. Our new free catalogue is packed with programs suitable for all ages from six to adult on a wide range of educational and leisure subjects.

Subjects now available include ...

Maths	Science	Arithmetic
French	Geography	Football
German	History	Sport
Spanish	English Words	First Aid
Italian	Spelling	General Knowledge

Kosmos Software Ltd, FREEPOST (no stamp needed)
DUNSTABLE, Beds. LU5 6BR
Telephone 0525 873942 or 875406

UK producers of educational software since 1983

Write or telephone for our new FREE 16-page colour brochure of Educational and Leisure software (Please state computer type)

SOCCER KID ON HIS QUEST TO FIND THE MISSING WORLD CUP SOCCER KID REACHES AN OPERA HOUSE IN ITALY,....

STORYLINE: TIM JAMES

COMING SOON: SOCCER KID, ONLY FROM KRISALIS SOFTWARE WITH MORE TRICK SHOTS THAN GAZZA!!

SAVE £50!
OFF PREVIOUS SILICA PRICE OF £299

Commodore

CARTOON CLASSICS

A500 'PLUS' MODEL

FREE!

ZOOL SOFTWARE PACK

ZOOL STRIKER
TRANSWRITE

PLUS! PINBALL DREAMS
GFA BASIC AND PHOTON PAINT 2.0

TOTAL VALUE: **£267.87**

WITH THE AMIGA 500

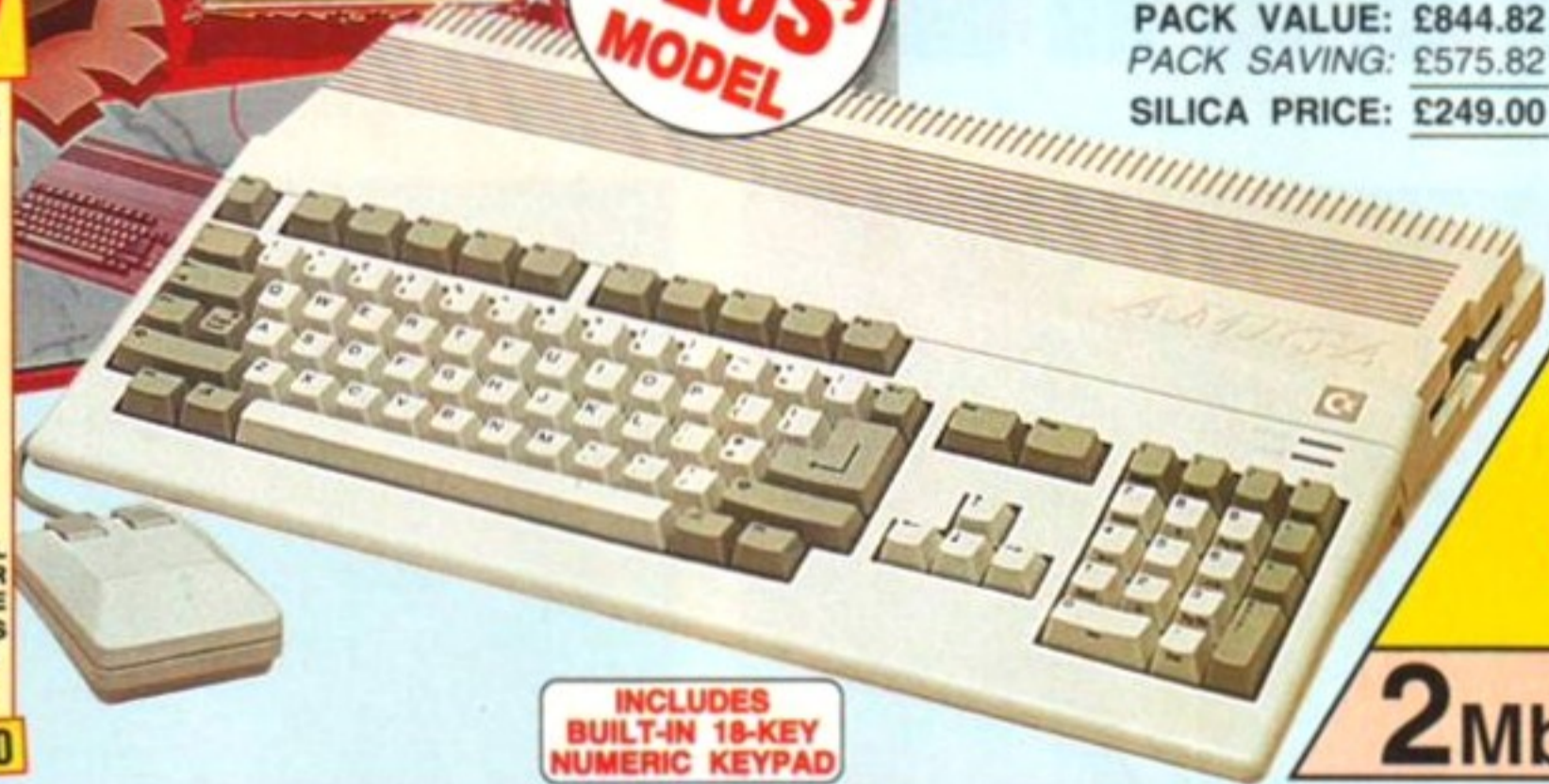

INCLUDES BUILT-IN 18-KEY NUMERIC KEYPAD

AMIGA 500

CARTOON CLASSICS

PACK INCLUDES:

- 1Mb AMIGA 500 PLUS..... £399.99
- BUILT-IN 1Mb DRIVE..... FREE
- A520 TV MODULATOR..... FREE
- THE SIMPSONS..... £24.99
- CAPTAIN PLANET & THE PLANETEERS..... £25.99
- LEMMINGS..... £25.99
- DELUXE PAINT II..... £79.99

PLUS! FREE FROM SILICA:

- ZOOL PACK..... £127.92
- PHOTON PAINT v2.0..... £89.95
- GFA BASIC v3.5..... £50.00

PACK VALUE: **£844.82**
PACK SAVING: **£575.82**
SILICA PRICE: **£249.00**

SALE!

We are pleased to offer the original 1Mb Amiga 500 Plus (Kickstart/Workbench v2.04), including a built-in 18-key numeric keypad and Cartoon Classics software at a new low sale price of only £249. The Amiga 500 Plus can be upgraded, using any of the hundreds of peripherals that are now available, which include the award winning GVP range. In addition to the 1Mb version of the Cartoon Classics pack at only £249, we are pleased to offer a specially upgraded version with 2Mb RAM for only £279. And, when you buy an Amiga 500 Cartoon Classics Pack from Silica (1Mb or 2Mb version), we will give you a ZOOL PACK plus GFA BASIC and PHOTON PAINT II worth over £267, absolutely FREE!

1Mb A500 PLUS CARTOON CLASSICS
£249

INC VAT - Ref: AMC 0592

2Mb RAM VERSION **£279** INC VAT
AMC 0592 + RAM 0592

RETURN THE COUPON FOR YOUR FREE COPY OF SILICA'S NEW 64PAGE AMIGA CATALOGUE!

CDTV™ MULTIMEDIA SYSTEM

- Easy to use home entertainment system
- Infrared Remote Control
- Sleek black design
- Keyboard, disk drive and mouse included
- Based on the best selling Amiga computer
- Plays CD audio discs
- Compatible with CD+G & CD+MIDI formats
- Over 100 CDTV titles available
- Compatible with 100s of Amiga programs
- Fred Fish CDPD is a 'collection' of 660 disks of public domain software. It includes utilities, applications, games and tools.

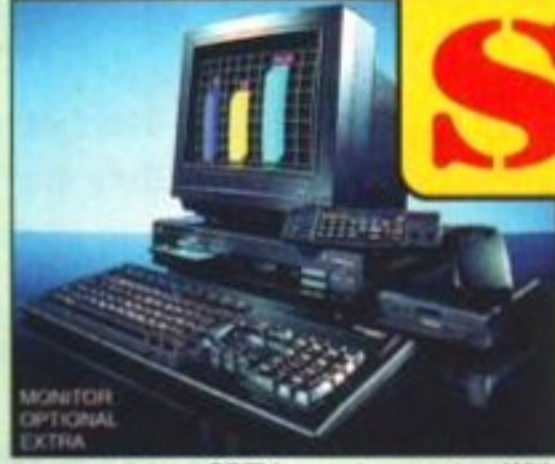

A complete CDTV environment. With keyboard and disk drive it is fully software compatible with the Amiga 500, and able to run all Amiga games and application software. £50 of CDTV software vouchers PLUS Sim City (worth £29.99) are included FREE with every CDTV Multimedia System from Silica.

CDTV Player	£399.99
CDTV Keyboard	£49.99
CDTV Disk Drive	£99.99
Fred Fish CDPD	£19.99
Sim City	£29.99
Software Vouchers	£50.00
Total Pack Value:	£649.95
Less Pack Saving:	£150.95
Silica Price:	£499.00

FREE!
FROM SILICA with the CDTV Multimedia System
SIM CITY
ENHANCED CD VERSION
£50 of CDTV SOFTWARE VOUCHERS
WORTH NEARLY **£80**

£499
Ref: CCD 1250

AMIGA CDTV SALE!

FREE!
FROM SILICA with the A570
SIM CITY
ENHANCED CD VERSION
£50 of CDTV SOFTWARE VOUCHERS
WORTH NEARLY **£80**

CDTV™ AMIGA A570 ADD-ON FOR AMIGA 500 OWNERS

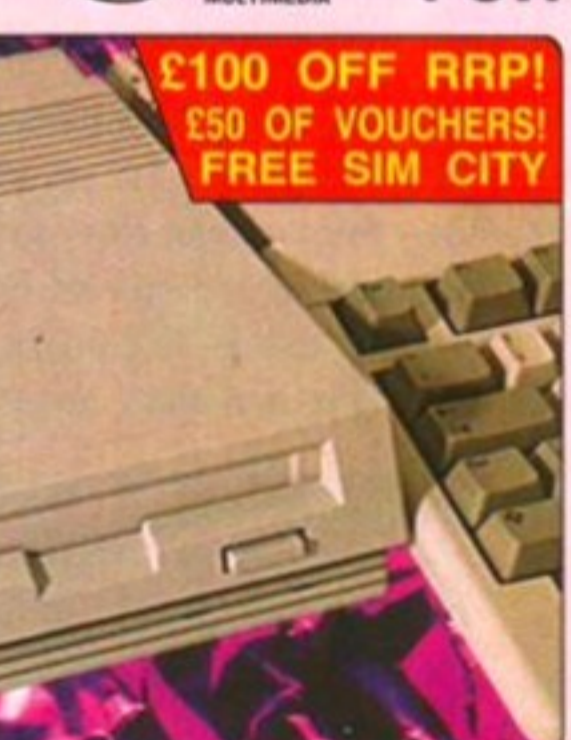

£100 OFF RRP!
£50 OF VOUCHERS!
FREE SIM CITY

- Enables your Amiga to run CDTV software
- Plays normal audio CD discs
- Storage capacity equal to 600 floppy disks
- Internal RAM expansion option (Coming Soon)
- Internal hard drive option (Coming Soon)
- Compatible with CD + G and CD + MIDI formats
- Transfer time 153Kb/second
- Compatible with CD-ROM industry standard ISO9660
- Comes with Fred Fish CDPD collection + Sim City FREE from Silica

Note: 1Mb of Chip RAM/FAT Agnus is required for full compatibility with all CDTV software. Silica offer an upgrade service. Please call and quote REA 1000.

SAVE £100! OFF NORMAL RRP OF £349

£249
Ref: CCD 0588

ALL PRICES INCLUDE VAT - DELIVERY IS FREE OF CHARGE IN THE UK MAINLAND

SILICA SYSTEMS OFFER YOU

- **FREE OVERNIGHT DELIVERY:** On all hardware orders shipped in the UK mainland.
- **TECHNICAL SUPPORT HELPLINE:** Team of technical experts at your service.
- **PRICE MATCH:** We normally match competitors on a "Same product - Same price" basis.
- **ESTABLISHED 14 YEARS:** Proven track record in professional computer sales.
- **£12 MILLION TURNOVER (with 60 staff):** Solid, reliable and profitable.
- **BUSINESS + EDUCATION + GOVERNMENT:** Volume discounts available 081-308 0888.
- **SHOWROOMS:** Demonstration and training facilities at our London & Sidcup branches.
- **THE FULL STOCK RANGE:** All of your requirements from one supplier.
- **FREE CATALOGUES:** Will be mailed to you with offers + software and peripheral details.
- **PAYMENT:** Major credit cards, cash, cheque or monthly terms.

Before you decide when to buy your new Amiga computer, we suggest you think very carefully about WHERE you buy it. Consider what it will be like a few months after buying your Amiga, when you may require additional peripherals or software, or help and advice with your new purchase. And, will the company you buy from contact you with details of new products? At Silica Systems, we ensure that you will have nothing to worry about. We have been established for almost 14 years and, with our unrivalled experience and expertise, we can now claim to meet our customers' requirements with an understanding which is second to none. But don't just take our word for it. Complete and return the coupon now for our latest FREE literature and begin to experience the "Silica Systems Service".

MAIL ORDER HOTLINE
081-309 1111



MAIL ORDER:	1-4 The Mews, Hatherley Rd, Sidcup, Kent, DA14 4DX	Tel: 081-309 1111 Fax No: 081-308 0608
LONDON SHOP:	52 Tottenham Court Road, London, W1P 0BA	Tel: 071-580 4000 Fax No: 071-323 4737
LONDON SHOP:	Selfridges (1st Floor), Oxford Street, London, W1A 1AB	Tel: 071-629 1234 Extension: 3914
SIDCUP SHOP:	1-4 The Mews, Hatherley Rd, Sidcup, Kent, DA14 4DX	Tel: 081-302 8811 Fax No: 081-309 0017
ESSEX SHOP:	Keddies (2nd Floor), High Street, Southend-on-Sea, Essex, SS1 1LA	Tel: 0702 468039 Fax No: 0702 462363

To: Silica Systems, AMFOR-0393-100, 1-4 The Mews, Hatherley Rd, Sidcup, Kent, DA14 4DX

PLEASE SEND A 64 PAGE AMIGA COLOUR CATALOGUE

Mr/Mrs/Miss/Ms: Initials: Surname:

Company Name (if applicable):

Address:

Postcode:

Tel (Home): Tel (Work):

Which computer(s), if any, do you own?

Wing Commander

Just another flight-sim or will Wing Commander take you to new heights in gameplay? We take to the skies to find out...

AMIGA FORMAT

94

MARCH 1993



"Scramble, scramble, scramble, we're under attack, bogies coming in at 12 o'clock. All available pilots to the ship's hangers. Would Captain Falcon please report to bay 16."



View of your helmet's visor as you're ejected from your craft and you float out to space. But don't eject too often as starfighters are expensive.

"Glad to see you made it back Falcon. Heard you and Spirit had a bit of a scrap" exclaimed Shotglass the barman, as I entered the room. I replied with a weary smile. Exhausted, I slumped into a chair by the nearest table. It had been a bitch of a day. The Kilrathi had fought hard and fast - my ship had been shot and I had barely made it back. No sooner had I climbed out of the cockpit, than the CO ordered me to his office. "What now?", I thought. I was expecting a reprimand, instead I received a promotion. Maybe life isn't such a bitch after all."

Wing Commander isn't just a flight simulation. It's an atmospheric, cinematic-type cocktail of shoot-em-up, flight simulation, role-playing and all-round good fun. The whole game has a real Star Wars feel to it, you really feel like you're in the middle of an epic blockbuster.

The graphics are smooth and impressive, with an almost adventure cartoon feel to them.

The synthesised symphonic sound is awesome and always sets the mood of the scene you're in - from martial-like movements when you're fighting to expectorant tinkering when you're waiting in the CO's office for instructions.

This is a story about man's fight against



This view shows a Kilrathi fighter that has been 'targeted', depicted by the red square.



an alien race of cat-like creatures called the Kilrathi; they are intent on destruction, and it's up to you to stop them. But first you have to assign yourself a name and call sign (mine's Falcon), your character is then created and the real game begins.

One of the first scenes is set in Shotglass' bar, where you meet two other pilots, who provide you with useful information to help you on your forthcoming missions. You then move on to the barracks. You walk into a dimly lit room with walls lined with lockers and medals that you've won in battle. Next to each locker is a bed and by clicking on the head of a bed, you can save your current campaign on to disk. As you do this, a sleeping pilot appears on the bed to signify that it's been saved.

The briefing room sets the next scene and this is where you're presented with your mission. The graphic detail here is simple, but effective, with an audience of silhouetted, seated pilots all listening intently to the CO. The music becomes more intense and you

A VIEW TO A KILL



Step 1: select a target. The best option is to try to get on its tail. Frontal attacks are suicidal.



Step 2: select missiles. If you're in the right position a countdown locking sequence will start.



Step 3: "Missile locked, FIRE!" Splash one Kilrathi! The sky is safe once again.

FOOTBALL TACTICIAN 2

**We set the standards
We break the records.**

Widely accepted as the most accurate football simulation available, **FOOTBALL TACTICIAN 2** has taken the strategy scene by storm. Record after record is being broken:

- * **Biggest ever multi-user system:** up to 46 users! (who said four was the limit?) Now with new rating system reflecting managers' ability and achievements.
- * **First ever fully interactive management game:** intervene at any time during a match to change tactics, make substitutions, adjust formation or mark players.
- * **Most accurate player definition:** 30 parameters including real ages, aptitudes, skills, caps, playing positions, fitness, morale and market valuation.
- * **Most accurate teams:** 20-player squads updated EVERY WEEK! If your game still lists Des Walker at Forest or Eric Cantona at Leeds, then it isn't Football Tactician!
- * **Largest results database:** 21290 match results and league positions going back 20 seasons all instantly retrievable. All of which may be printed out.
- * **Largest ever recording options:** 36 matches always recorded IN FULL for instant full-scale replay, plus selected REAL matches that actually took place in real life.
- * **First ever referee involvement:** true to life behaviour. Beware of adopting 'rough tactics' when Jim Parker is in charge! The message is clear: know your refs.
- * **Fastest ever setting-up time:** initial start-up in less than two seconds, thanks to 900K of super-fast machine code. Smoothness of action is FT2's hallmark.
- * **Most accurate editor:** built-in intuitive editor capable of entering new players and fine-tuning all parameters. Essential for the serious user.
- * **First ever simulation capable of replaying REAL matches** (ex: the Leeds- Rangers clash in the European Cup)
- * **First ever Scottish only simulation:** FT2 Scotland now available separately.

FOOTBALL TACTICIAN is the first ever management game that includes strategy as an integral part of a successful campaign. Team selection, needless to say, remains a critical element. But the BIG innovation is your involvement during the match: for the first time ever, you will, as a manager, be able to alter your strategy: choose a defensive or offensive system, mark certain opponents, drop back some of your players if the pressure is tough, decide exactly when substitutions should be made, play the off-side trap, go for quick counters, etc... With full on-screen commentary and minute-by-minute feed-back, you're as involved in the match as any of your players! You will soon realise that this is no ordinary soccer manager. THIS is the REAL THING. You're in charge. You manage your side before and during the match. Nothing is left to chance. Can you rise to the challenge? Try FOOTBALL TACTICIAN and prepare yourself for the ultimate football experience.

New features include:

- * FA Premier League and Division One permanently in memory with full interaction, promotions, transfers, play-offs, local and European Cups.
- * 900 players accurately and meticulously named, plus accurate European players
- * Unique database-type search facility plus comprehensive data link giving access to additional, accurate, historical information on selected players. This feature may be further enhanced by the user himself.
- * Intelligent behaviour of computer sides capable of changing tactics to respond to situation on the field or making substitutions based on fitness and fatigue.
- * Three levels of commentary, from highlights only to ball by ball reporting. Plus mid-week transfer and fitness news.
- * Friendlies, top scorers charts, precise transfer markets, club history, financial position and much much more!

No known football game is more accurate! FT2 is updated weekly: transfers, bids, injuries are recorded as they happen, not a year later. Users ALWAYS receive the very latest version.



And now FT2 SCOTLAND! With the Premier AND First Divisions and of course all the unique characteristics and playability of the original Football Tactician 2.

Please rush 1 copy of
FOOTBALL TACTICIAN 2 (one meg required) £22.95
FOOTBALL TACTICIAN 2 (Scotland) (one meg) £22.95
 Also available:
FOOTBALL TACTICIAN 1 (half-meg machines) £16.95
 coming soon: **FT2 Italia Serie A**
 I own an AMIGA A500 A600 A1200 ATARI ST/STE

Name _____
 Address _____

I enclose cheque for _____ My Visa number is _____
 Visa or Access orders: same-day dispatch Overseas please add £1 p&p

TALKING BIRDS 0702 523607
 5 Minster Close Rayleigh Essex SS6 8SF



Ejection: time to leave. Your visor lowers and an animated sequence begins ...

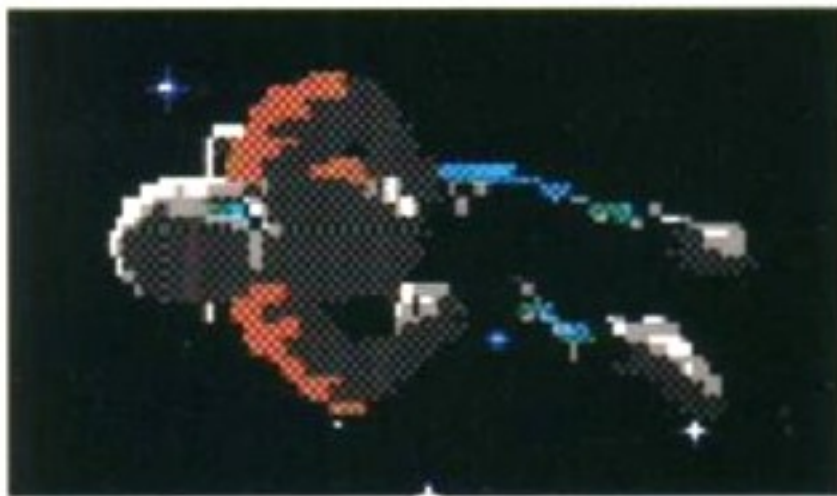

...culminating in a view of you slowly floating off into the great abyss.

know it's going to be a dangerous assignment. Before you know it, you're strapped into your new supersonic fighter. And it is at this point that you will realise *Wing Commander* is no ordinary shoot-em-up or flight sim. You don't just simply climb into the plane's cockpit and shoot down loads of spaceships. You and other pilots run towards your aircraft in an atmospheric and beautifully animated scene.

An element of strategy comes into play when you begin to confront the Kilrathi. First you've got to activate your navigation screen and find your first waypoint. Invariably, you will meet the enemy, and engaging in combat with them will set your heart thumping. When a spaceship is targeted, a cross-hair appears on screen and an audible locking sequence commences, and then it's time to fire. As the storyline progresses, the missions you are sent on become harder.

Origin really do excel in producing games with clever and detailed graphics, and *Wing*



Thank you, sir.

Yes you've guessed it, another medal and another promotion, a view of your character.



"Pilot Falcon requesting permission to land"
 An aerial view of a fighter landing.

Commander is no exception. The rendering of the figures and individual scenes appear very real. Ejecting out of your aircraft is especially awe-inspiring - as you are catapulted out of your ship the vastness of space appears before you. Then, you see a close-up of your visor with a 'beacon-on' sign at the top, and reflected in this is the ensuing battle.

The game does seem a bit slow if you're playing on an A600, and if you haven't got a hard drive or separate drive you have to keep swapping between disks, although this shouldn't spoil your enjoyment.

Wing Commander is what you could call a shoot-em-up with class. The mood-inspiring music, the clever saving system and the slick animated sequences all add-up to a game that will keep you coming back for more.

Derek 'Falcon' Davis. ☺

Wing Commander Mindscape ■ £25.99

- Visually impressive - almost a cinematic feel, with great attention to detail.
- The campaign saving option is very handy.
- Good development of narrative makes it interesting throughout.
- More exciting than a rerun of *Top Gun* and *Star Wars* put together.

(Verdic) **83%**
 FORMATS

Reach the top with.....

NATIONAL CURRICULUM

LCL Self-Tuition Courses

World leaders ● Hons graduate/teacher authors ● In educational software charts. ● Excellent reviews. (e.g. "Definitely a first class package" AMIGA SHOPPER) ● £5 off total for 2, £10 off for 3.

INCREDIBLE VALUE: 24-PROGRAM COURSES WITH A BOOK & MANUAL FOR ONLY £24 EACH

(Micro Series have outstandingly good graphics & music for that level) **Totally comprehensive courses** with far too many features & topics to list, but some examples are:

MICRO SCIENCE (8 years - GCSE)

NEW

Physics & Chemistry practical experiments ● Biology demonstrations ● Graphics adventure game (1Mb required)

MICRO MATHS (11 years - GCSE)

GCSE CHART-TOPPER

Algebra ● Geometry ● Trigonometry ● Statistics ● Arithmetic

MICRO FRENCH (Beginners - GCSE)

ST. F "Best Buy"

Real speech ● Graphics adventure game ● Talking cartoon

MICRO GERMAN (Beginners - GCSE & Business)

Real speech ● Graphics adventure game ● Business letter generator

MICRO ENGLISH (8 years - GCSE)

Spelling ● Punctuation ● Grammar ● Literature

PRIMARY MATHS COURSE (3-12 years)

in ATARI Fam. C.

Tables ● + - x ÷ ● HTU ● Long & short multiplication ● Fractions

READING WRITING COURSE (3-12 years)

NEW ENLARGED

Alphabet ● Handwriting ● Creative writing ● Reading ● Spelling

MEGA MATHS (A level course)

All AMIGAS even A1200

Calculus ● Algebra ● Geometry ● Full-screen graphs

★ Or equivalent

(*All appropriate LCL Courses are National Curriculum compatible & run on most computers.) Send cheques/P.O.s (+99p P&P) or phone orders, or requests for free colour poster/catalogues to:

LCL (DEPT AMF), THAMES HOUSE, 73 BLANDY ROAD, HENLEY-ON-THAMES, OXON RG9 1QB

VISA or ring 0491 579345 (24 hrs) **Access**

TECHNOMANIA

Featuring ...

TECHNOSOUND Turbo

BRITAIN'S No1 Sound Sampling System

"EVERY AMIGA OWNER SHOULD HAVE IT" - Amiga Format

ONLY **£27.99** NORMAL RRP **£39.99**

SAVE £12



ROMBO

RGB Colour Splitter**£39.99** **SAVE £40**

Take 2 Animation.....**£34.99** **SAVE £65**

POWER

Hand Scanner V2.0**£94.99**

Itsa Mouse**£12.99**

ORDER FORM

PLEASE SEND ME

Name

Address

I ENCLOSE CHEQUE/PO FOR

FIRECREST DISTRIBUTION

P.O. Box 39, ABERGAVENNY, GWENT NP7 6XL. TEL (0873) 850028

Please phone for complete price list.

ADD £2.00 PER ITEM P&P

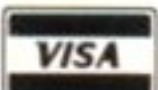

PREMIER MAIL ORDER

Titles marked * are not yet available and will be sent on day of release. Please send cheque/PO/Access/Visa No. and expiry date to:

Dept AF44, 10 Tinkler Side, Basildon, Essex SS14 1LE

Please state make and model of computer when ordering. P&P inc. UK on orders over £5.00. Less than £5.00 and Europe add £1.00 per item. Elsewhere please add £3.00 per item for Airmail. These offers are available Mail Order only. Telephone orders: Mon-Fri 9am-7pm. Saturday and Sunday 10am-4pm. Tel orders: 0268 271172 Fax orders: 0268 271173

Next day service available add £2.50 - ring for details.

Check to see if games are 1 Meg Capacity.

3D Con Kit 2.....34.99	Daley Thompson Challenge.....6.99	Hard Drivin.....6.99	Mega Sports.....19.99	Shoot Em Up Con Kit.....8.99
AV8B Harrier Assault.....22.99	Dark Sun: Shattered Lands *.....21.99	Harlequin.....16.99	Mega Traveller 1 (1 Meg).....19.99	Shuttle.....19.99
Abandoned Places.....19.99	Dark Queen of Krynn.....22.99	Harpoon + Battleset 2.....22.99	Mega Traveller 2 (1 Meg).....19.99	Silent Service 2 (1 Meg).....22.99
Addams Family.....16.99	Death Knight.....20.99	Harpoon Battleset 3.....9.99	Microprose Golf.....22.99	Silkworm.....8.99
A320 Airbus (USA).....22.99	Death Knights Of Krynn (1 Meg).....19.99	Harpoon Battleset 4.....9.99	Midwinter 2 (1 Meg).....22.99	Silly Putty.....16.99
Air, Land, Sea.....24.99	Deluxe Paint 4.....54.99	Harpoon Scenario Editor.....13.99	Moonstone (1 Meg).....19.99	Sim City+Populous.....19.99
Air Support.....19.99	Deluxe Paint 4 AGA.....64.99	Harrier Jump Jet.....22.99	New Zealand Story.....6.99	Sim Earth.....22.99
Alien 3.....19.99	Demonsgate *.....22.99	Head Over Heels.....6.99	Nick Faldo's Golf.....22.99	Space Crusade.....16.99
Alien Breed Special Edition.....10.99	Desert Strike *.....19.99	Head to Head.....22.99	Nigel Mansell World Champ.....19.99	Special Forces.....22.99
Altered Beast.....6.99	Dizzy Collection.....16.99	Heart Of China (1 Meg).....22.99	No Second Prize.....19.99	Strategy Masters.....20.99
Amberstar.....19.99	Doodle Bug.....17.99	Heimdall (1 Meg).....19.99	Operation Wolf.....6.99	Street Fighter 2.....19.99
Amos The Creator.....29.99	Double Dragon.....8.99	History Line 1914-18.....22.99	Ork.....19.99	Strider.....6.99
Amos 3D.....24.99	Double Dragon 2.....8.99	Hook.....16.99	Outrun.....6.99	Striker (1 Meg).....16.99
Amos Compiler.....19.99	Double Dragon 3.....16.99	Humans.....19.99	Pang.....6.99	Strip Poker 2 + Data.....6.99
Amos Professional.....44.99	Dragons Lair 3.....22.99	Ian Botham.....19.99	Paperboy 2.....16.99	Stunt Car Racer.....6.99
Another World.....19.99	Dreadnought.....22.99	IK+.....6.99	Parasol Stars.....16.99	Super Fighter.....17.99
Aquatic Games.....16.99	Dream Team.....17.99	Indy Jones - Atlantis Action.....19.99	PGA Golf Courses.....9.99	Superfrog.....17.99
Arkanoid 2.....6.99	Dune.....19.99	Indy Jones - Atlantis Adv (1 Meg).....24.99	PGA Tour Golf+.....19.99	Super Hang On.....6.99
Award Winners.....16.99	Dungeon Master Chaos.....19.99	Int Sports Challenge.....19.99	Pinball Dreams.....16.99	Super Tetris.....16.99
Archer Maclean's Pool.....16.99	Dynablaster.....19.99	Ishar.....19.99	Pinball Fantasies.....19.99	Team Yankee 2 (1 Meg).....19.99
Arsenal FC *.....16.99	Easy Amos.....29.99	Jack Nicklaus Extra Courses.....10.99	Pool of Radiance (1 Meg).....19.99	The Manager.....19.99
Ashes of Empire.....22.99	Elite 2 *.....22.99	Jack Nicklaus Golf.....7.99	Pools of Darkness (1 Meg).....21.99	Their Finest Hour (1 Meg).....19.99
Assassin.....16.99	Epic.....19.99	Jack Nicklaus Unlimited Golf (1 Meg).....19.99	Populous.....8.99	Titus The Fox.....16.99
A-Train *.....22.99	Euro Football Champ.....16.99	Jaguar XJ220 (1 Meg).....16.99	Populous 2+.....22.99	Top League.....20.99
B.C. Kid.....17.99	Eye of the Beholder (1 Meg).....19.99	Jimmy Whites Snooker.....19.99	Populous Challenge Disk.....10.99	Tornado.....16.99
B17 Flying Fortress (1 Meg) *.....22.99	Eye Of The Beholder 2 (1 Meg).....21.99	John Madden.....16.99	Powermonger.....19.99	Troddlers.....16.99
Batman The Movie.....6.99	Eye of the Storm *.....19.99	Jo & Mac Cavenan Ninja *.....17.99	Powermonger Data Disk 1.....9.99	Turbo Challenge.....8.99
Bat 2 (1 Meg).....26.99	F15 Strike Eagle 2 (1 Meg).....22.99	Keys of Maramon *.....16.99	Premiere (1 Meg).....19.99	Turbo Challenge 2.....16.99
Battletoads.....19.99	F16 Combat Pilot.....8.99	KGB *.....20.99	Premier Manager.....17.99	Turbo Challenge 3.....16.99
Bill's Tomato Game.....19.99	F19 Stealth Fighter.....19.99	Kings Quest 5 (1 Meg).....22.99	Prince of Persia.....4.99	TV Sports Baseball.....19.99
Billy the Kid *.....16.99	Falcon 3 *.....24.99	Knights of the Sky (1 Meg).....22.99	R-Type.....6.99	Universal Monsters *.....17.99
Birds of Prey (1 Meg).....22.99	Fantastic Worlds.....20.99	Laser Squad 2 *.....16.99	Railroad Tycoon (1 Meg).....22.99	Utopia + Data Disk.....19.99
Bitmap Bros Vol 2 *.....17.99	Ferrari Grand Prix *.....17.99	Leads United.....17.99	Rainbow Collection.....13.99	Wing Commander (1 Meg).....22.99
Black Crypt.....19.99	Fire Force.....16.99	Leander.....16.99	Rainbow Islands.....6.99	Walker.....16.99
Blues Brothers.....8.99	Fire and Ice.....16.99	Leathal Weapon 3.....16.99	Ramparts.....16.99	Warworks.....22.99
Bonanza Bros.....16.99	First Samurai + Mega-Lo-Mania.....19.99	Legend.....21.99	Raving Mad.....17.99	Ween *.....19.99
Board Genius.....19.99	Flag *.....19.99	Legend of Kyrandia.....23.99	Reach for the Skies *.....22.99	Western Front *.....20.99
Bubble Bobble.....6.99	Flash Back *.....19.99	Legends of Valour.....20.99	Red Zone.....16.99	Winter Challenge *.....22.99
California Games 2.....16.99	Flood.....8.99	Lemmings + Data Disk.....19.99	Renegade 2 *.....16.99	World Class Cricket.....19.99
Carl Lewis Challenge.....16.99	Football Crazy.....16.99	Lemmings Construction Kit *.....16.99	Risky Woods.....16.99	Wizkid.....16.99
Campaign.....22.99	Football Director 2 (1 Meg).....16.99	Lemmings Data Disk.....13.99	Road Rash.....19.99	Zool.....17.99
Castles.....19.99	Football Manager 3 *.....16.99	Lemmings 2 *.....17.99	Robocop.....8.99	Zool A1200.....16.99
Championship Manager (1 Meg).....16.99	Formula One Grand Prix.....22.99	Links.....24.99	Robocop 3.....16.99	
Chaos Engine.....16.99	Games 92-Espana.....19.99	Lombard Rally.....6.99	Robo Sport.....19.99	
Chuck Rock 2 *.....16.99	Ghostbusters 2.....6.99	Last Treasure of Infocom.....32.99	Rome AD 9 *.....16.99	
Civilisation (1 Meg).....22.99	Ghouls and Ghosts.....6.99	Lure of the Temptress.....19.99	Rookies *.....19.99	
Combat Classics.....19.99	GLOC.....16.99	M *.....21.99	Sabre Team.....16.99	
Combat Air Patrol *.....19.99	Gobliins 2.....16.99	M1 Tank Platoon.....19.99	Scrabble *.....18.99	
Conan The Cimmerian *.....19.99	Gods.....16.99	Magic Boy *.....17.99	Secret of Samurai *.....16.99	
Contraptions *.....13.99	Graham Gooch *.....19.99	Magic Pockets.....16.99	Secret of Monkey Island (1 Meg).....16.99	
Cool World *.....17.99	Graham Taylor.....16.99	Man Utd, Europe.....16.99	Secret Monkey Island 2.....24.99	
Covert Action (1 Meg).....22.99	Grusome *.....16.99	Match of the Day.....16.99	Sensible Soccer 92/93.....16.99	
Crazy Cars 3.....16.99	Gunship 2000 * (1 Meg).....22.99	Mcdonalds Land *.....16.99	Shadow Lands.....19.99	
Cruise For A Corpse.....19.99	Guy Spy.....19.99	Mega Fortress (1 Meg).....22.99	Shadow Worlds.....17.99	
Crystal Kingdom Dizzy *.....14.99			Shadow of Beast 3.....19.99	
Curse of Enchata.....22.99				

SPECIAL OFFERS

Kick Off 2 Final Whistle.....7.99
Kick Off 2 Giants of Europe.....7.99
Kick Off 2 Return to Europe.....7.99
Kick Off 2 Winning Tactics.....5.99
Kick Off 2 1 Meg.....9.99
Kick Off 2 i Meg.....7.99
Shadow Of Beast 2.....6.99
The Kristal.....9.99
Mercenary 3.....9.99
Popeye 2.....5.99
Thunderstrike.....6.99
Seymour Goes to Hollywood.....6.99
Mega Lo Mania.....9.99
Turbo Challenge 2.....12.99
Chuck Rock.....10.99
Turtles 2 Coin OP.....16.99
Abandoned Places.....19.99
Cool Croc Twins.....16.99
Prince of Persia.....4.99

EDUCATIONAL

The Three Bears (5-10).....13.99
Magic Math (4-8).....13.99
Maths Mania (8-12).....13.99
Junior Typist (5-10).....10.99
Better Spelling (8-14).....13.99
Better Maths (12-16).....13.99
Noddys Playtime (3+).....
Fun School 2 (6-8).....6.99
Fun School 2 (+8).....6.99
Fun School 2 (U6).....6.99
Fun School 2 (5-7).....16.99
Fun School 3 (+7).....16.99
Fun School 3 (U5).....16.99
Fun School 4 (5-7).....16.99
Fun School 4 (7-11).....16.99
Fun School 4 (U5).....16.99

JUNIOR ADVENTURE

A Christmas Carol.....	Scrooge (+8).....13.99
Robin Hood.....	Robin Hood (+8).....13.99
The Wind in the Willows.....	The Wind in the Willows (+6).....13.99

BLANK DISKS

TDK - Boxed.....	20 x 3.5".....£10.99
10 x 3.5".....£7.99	50 x 3.5".....£23.99
20 x 3.5".....£14.50	100 x 3.5".....£44.99
50 x 3.5".....£35.00	Recycled - Loose.....
Precision - Boxed.....	10 x 3.5".....£4.50
10 x 3.5".....£6.45	20 x 3.5".....8.50
20 x 3.5".....£11.99	50 x 3.5".....16.00
50 x 3.5".....£26.00	100 x 3.5".....30.00
Unbranded - Loose.....	10 x 3.5".....£5.99

JOYSTICKS/ACCESSORIES

1/2 Meg Upgrade.....	24.99
1/2 Meg Upgrade + Clock.....	26.99
3.5 External Disk Drive.....	49.99
Quick Joy Top Star.....	17.99
Quick Joy 2 Turbo.....	10.99
Quick Joy Jet Fighter.....	10.99
Computek Fighter.....	5.99
Cheetah 125+.....	7.99
Competition Pro Extra.....	14.99
Competition Pro 5000.....	13.99

THE WORLD'S No 1

GVP

GREAT VALLEY PRODUCTS

AMIGA PERIPHERALS

ACCELERATORS

FOR THE AMIGA 1500/2000/4000
All GVP G-Force accelerators can be turned into a hard card by adding a Mount Kit (GVA 4251 - £34.95). Any 1" SCSI drive can then be mounted on to the accelerator.

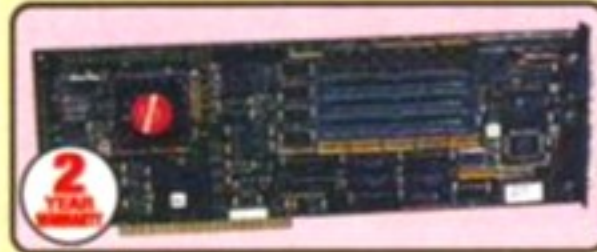

	030 25MHz	030 40MHz	030 50MHz	040 33MHz
Processor	68030EC	68030EC	68030	68040
Speed MIPS	7.48	12.1	15	30
Speed MHz	25	40	50	33
Math co-roc	68882	68882	68882	Built-in
Standard 32-bit RAM	1Mb	4Mb	4Mb	4Mb
Maximum 32-bit RAM	13Mb	16Mb	16Mb	16Mb
Extras	SCSI	SCSI	SCSI	SCSI Ser/Par
Code	UPG 0110	UPG 0430	UPG 0533	UPG 0740
PRICE	£499	£799	£1099	£1499



The Impact II HC8 hard cards are the equivalent of the HD8+ hard drive, but for the 1500 and 2000 models. They are some of the fastest hard drives available, and incorporate an unpopulated 8Mb RAM expansion.

HARD CARDS

FOR THE AMIGA 1500 & 2000
• Factory installed Hard Drives
• 0, 80, 120, 213, & 420Mb options
• On-board 8Mb memory sockets
• Add up to 6 SCSI devices

0Mb	HAR 1300	£129
40Mb	HAR 1340	£299
80Mb	HAR 1388	£349
120Mb	HAR 1422	£429
213Mb	HAR 1533	£579

Return the coupon now for your **FREE** copy of Silica Systems **NEW GVP CATALOGUE**

SOUND SAMPLER



FOR ALL AMIGAS
• 8-bit stereo sampler
• Plugs into parallel port
• MIDI support for song input
• Extensive editing features

For the semi-professional and audio hobbyist a high quality 8-bit stereo sound sampler that connects into the parallel port on any Amiga 500, 600, 1500, 2000 or 3000 computer. Combined with one of the fastest, most powerful and easy-to-use sound and music editing programs available. Includes 4-track soundtracker file compatible sequencer.

~~£49.95~~ **£39.95**
Ref: MUS 2500

VIDEO GENLOCK



FOR ALL AMIGAS
• 2x Composite Video, 1x S-VHS inputs
• RGB Composite video & S-VHS outputs available simultaneously
• Sound mixer, 2 mono inputs and 1 output
• Full software control via control panel, hotkeys and/or ARexx

GVP's G-lock genlock is a true price/performance breakthrough. The G-lock genlock works with all Amiga computers and even supports the new Chroma Key modes of the ECS/AA chip set. It is the only choice for the mid-range Amiga video enthusiast.

Ref: VID 2500 **£349**

PLUG-IN HARD DRIVES FROM ONLY

PLUG-IN HARD DRIVE AMIGA 500/500PLUS

The A500-HD8+ provides the ultimate in hard disk performance, memory expansion and future expandability for the Amiga 500. It incorporates the same VLSI custom chip and FaaAST ROM SCSI driver which are used in GVP's Series II SCSI/RAM controllers for the A1500/2000. As a result the A500-HD8+ offers unbeatable hard disk performance. The easy-access Autoboot/Game Switch allows the hard disk to be disabled, ensuring compatibility with the few games that will not work with a hard disk.

Every A500-HD8+ incorporates the latest in hard disk technology with a factory installed and formatted 1" high, low power, 3 1/2" SCSI hard disk, offering storage capacities up to 213Mb.

The A500-HD8+ also offers the ultimate in expandability. Additional SCSI peripherals can be attached to the external SCSI port. Up to 8Mb of internal Fast RAM expansion can be installed using state-of-the-art SIMM memory modules. The unique internal Mini-Slot allows for future expansion. Every A500-HD8+ has its own dedicated power supply, ensuring that the Amiga 500 power supply will not be overloaded and an internal fan to prevent the unit from overheating.

WHAT THE PRESS SAY...
'Superb build, excellent aesthetics and blinding speed make this the best A500 hard drive' - AMIGA SHOPPER

'GVP claims this is the fastest hard drive in the world and none of our tests could prove that wrong - Untouchable. THE choice' - AMIGA SHOPPER

£299



PLUG-IN HARD DRIVE OPTIONS

MODEL	42Mb	80Mb	120Mb	213Mb
HD8+ HARD DRIVE	£299 INC VAT Ref: HAR 0840	£399 INC VAT Ref: HAR 0888	£499 INC VAT Ref: HAR 0922	£599 INC VAT Ref: HAR 0933

HD8+ HARD DRIVE A530 HD & ACCELERATOR

	HD8+	A530
HARD DRIVE		
SCSI HARD DRIVE	•	•
40, 80, 120 & 213Mb VERSIONS	•	•
ULTRA FAST ACCESS	•	•
TRANSFER RATE UP TO 2.100K/sec* (*THE RATE OF THE 213Mb HD)	•	•
ACCELERATOR		
40MHz 68030EC CPU	•	•
OPTIONAL 68882 MATHS CO-PROCESSOR	•	•
PLUGS AT 12.1 MIPS (FASTER THAN AN A3000)	•	•
HARDWARE SUPPORT TO MAP KICKSTART INTO 32-bit WIDE FAST RAM FOR FASTER OPERATION	•	•
RAM BOARD		
UP TO 8Mb OF 8 OR 9-bit FAST RAM (8 OR 9-bit WIDE SIMMS - 120ns OR QUICKER)	•	•
UP TO 8Mb OF 32-bit WIDE FAST RAM (32-bit WIDE SIMMS - 60ns)	•	•
1Mb POPULATED	•	•
OTHER FEATURES		
'CUT-OFF' FOR 100% GAME COMPATIBILITY	•	•
SCSI CONTROLLER FOR UP TO 7 DEVICES	•	•
VLSI CUSTOM CHIP	•	•
FaaAST ROM SCSI DRIVER	•	•
IDENTICAL COLOUR & STYLING TO THE A500	•	•
BUILT-IN FAN TO PREVENT OVERHEATING	•	•
DEDICATED POWER SUPPLY	•	•
'MINI-SLOT' FOR FUTURE EXPANSIONS (E.G. PC EMULATOR)	•	•
REMOVABLE MEDIA SUPPORT	•	•
DIRECT MEMORY ACCESS (DMA) STYLE FOR ULTIMATE PERFORMANCE	•	•
EASY-TO-USE SOFTWARE	•	•
2 YEAR WARRANTY	•	•

PLUG-IN HARD DRIVE + ACCELERATOR AMIGA 500/500 PLUS

The GVP A530 incorporates the same 68030EC processor found in most of the new GVP G-Force accelerator range, as well as using the same VLSI custom chip and FaaAST ROM SCSI driver that is used in GVP's Series II SCSI/RAM controllers for the A1500/2000.

It also incorporates the Motorola 68030EC processor running at a blistering 40MHz and the latest in hard disk technology with a factory installed and formatted 1" high, low power, 3 1/2" SCSI hard disk offering storage capacities up to 213Mb. Additional SCSI peripherals can be attached to the external SCSI port. Up to 8Mb of 32-bit wide Fast RAM expansion can be installed, using state-of-the-art SIMM memory modules (1Mb supplied as standard). A 68882 maths co-processor can also be added to the unit to boost the machine's math calculations. Every GVP A530 has its own dedicated power supply.



*... the build quality is excellent... in terms of performance, their gear is the best... their equipment is worth every penny! 94% AMIGA FORMAT 9/92

PLUG-IN HARD DRIVE & ACCELERATOR OPTIONS

MODEL	42Mb	80Mb	120Mb	213Mb
A530 COMBO HARD DRIVE & ACCELERATOR	£699 INC VAT Ref: HAR 0962	£799 INC VAT Ref: HAR 0968	£899 INC VAT Ref: HAR 0974	£999 INC VAT Ref: HAR 0983

PC EMULATOR

PLUG-IN OPTION FOR HD8+ & A530
• 16MHz 80286 processor
• 287 Maths Co-Processor socket
• 512K of PC RAM plus the use of Amiga RAM
• Supports Hercules, CGA, EGA/VGA (monochrome) and T3100 video modes
• Runs MS-DOS (3.2 and upwards) plus thousands of other PC programs



£149
Ref: EMU 0500

ALL PRICES INCLUDE VAT - DELIVERY IS FREE OF CHARGE IN THE UK MAINLAND

SILICA SYSTEMS OFFER YOU

- **FREE OVERNIGHT DELIVERY:** On all hardware orders shipped in the UK mainland.
- **TECHNICAL SUPPORT HELPLINE:** Team of technical experts at your service.
- **PRICE MATCH:** We normally match competitors on a "Same product - Same price" basis.
- **ESTABLISHED 14 YEARS:** Proven track record in professional computer sales.
- **£12 MILLION TURNOVER (with 60 staff):** Solid, reliable and profitable.
- **BUSINESS + EDUCATION + GOVERNMENT:** Volume discounts available 081-308 0888.
- **SHOWROOMS:** Demonstration and training facilities at our London & Sidcup branches.
- **THE FULL STOCK RANGE:** All of your requirements from one supplier.
- **FREE CATALOGUES:** Will be mailed to you with offers + software and peripheral details.
- **PAYMENT:** Major credit cards, cash, cheque or monthly terms.

Before you decide when to buy your new Amiga products, we suggest you think very carefully about WHERE you buy them. Consider what it will be like a few months after you have made your purchase, when you may require additional peripherals and software, or help and advice. And, will the company you buy from contact you with details of new products? At Silica Systems, we ensure that you will have nothing to worry about. We have been established for almost 14 years and, with our unrivalled experience and expertise, we can now claim to meet our customers' requirements with an understanding which is second to none. But don't just take our word for it. Complete and return the coupon now for our latest FREE literature and begin to experience the "Silica Systems Service".

MAIL ORDER HOTLINE
081-309 1111



MAIL ORDER: Order Lines Open: Mon-Sat 9.00am-6.00pm No Late Night Opening	1-4 The Mews, Hatherley Rd, Sidcup, Kent, DA14 4DX	Tel: 081-309 1111 Fax No: 081-308 0608
LONDON SHOP: Opening Hours: Mon-Sat 9.30am-6.00pm No Late Night Opening	52 Tottenham Court Road, London, W1P 0BA	Tel: 071-580 4000 Fax No: 071-323 4737
LONDON SHOP: Opening Hours: Mon-Fri 9.30am-7.00pm (Sat close 6.30pm) Late Night: Thursday - 8pm	Selfridges (1st Floor), Oxford Street, London, W1A 1AB	Tel: 071-629 1234 Extension: 3914
SIDCUP SHOP: Opening Hours: Mon-Sat 9.00am-5.30pm Late Night: Friday - 7pm	1-4 The Mews, Hatherley Rd, Sidcup, Kent, DA14 4DX	Tel: 081-302 8811 Fax No: 081-309 0017
ESSEX SHOP: Opening Hours: Mon-Fri 9.30am-5.30pm (Sat 9.00am-6.00pm) No Late Night Opening	Keddies (2nd Floor), High Street, Southend-on-Sea, Essex, SS1 1LA	Tel: 0702 468039 Fax No: 0702 462363

To: Silica Systems, AMFOR-0393-68, 1-4 The Mews, Hatherley Rd, Sidcup, Kent, DA14 4DX

PLEASE SEND A BROCHURE ON THE GVP RANGE

Mr/Mrs/Miss/Ms: Initials: Surname:

Company Name (if applicable):

Address:

Postcode:

Tel (Home): Tel (Work):

Which computer(s), if any, do you own?



"Your tea leaves say that you will soon fulfil your ambition, and become a ballet dancer..."

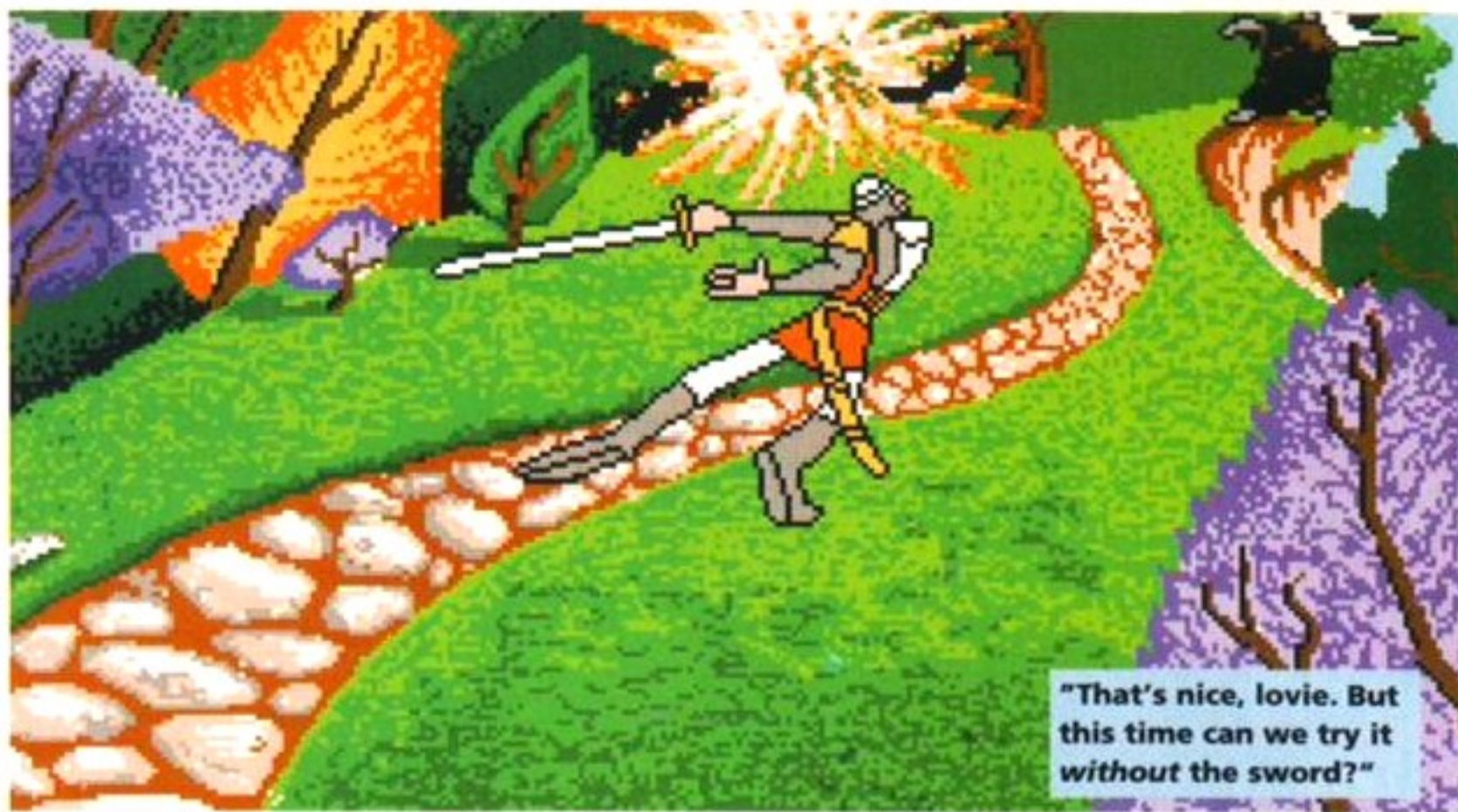

"That's nice, lovie. But this time can we try it without the sword?"

Dragon's Lair III

AMIGA FORMAT

98

MARCH 1993

Sit back, relax, and imagine a perfect gaming world. One where graphics, sound and gameplay all come together seamlessly to form the ultimate game. Moreover, the ultimate game is also available for the same price as a compact disc.

Was that as good for you as it was for me? Well I'm sorry, but we were both dreaming. Back in the real world, games can cost upwards of £20, and good gameplay is an exception, rather than the rule.

Makers of *Dragon's Lair III* – ReadySoft – have the knack of creating games which stretch the average Amiga's graphics and sound to its limits. Graphics that make a Disney blockbuster look fairly passé, and a soundtrack which wouldn't look out of place on CD and cassette. But – and it's one hell of a big but – their games lack any decent remnants of gameplay.

So, does *Dragon's Lair III* break the mould? As expected, the graphics and sound

After the original *Dragon's Lair* game died a death in the arcades and on disk, who'd have thought that Readysoft would ever get the third incarnation on to the Amiga? Believe it or not...

are excellent throughout. No qualms there then. The animation is some of the best you will find in a game – bright colours, sharp outlines and very smooth movement. You really couldn't ask for more.

The sound is equally impressive, using samples throughout, and there are ample amounts of speech. But this quality of sound is repeatedly broken up every time that you have to access one of the seven disks! With a single floppy drive gameplay is at its best dull, and at its worst downright irritating.

But I'll just install it on to my hard disk, so it won't be a problem after the first initial loading, I hear you say. Wrong there I'm afraid. Just to make you suffer that little bit more, *Dragon's Lair III* isn't hard disk installable! On top of that, the graphics screens only load one by one when required, although this doesn't utilise any extra memory. Anyway, on with the story...

Impressive or what?

In *Dragon's Lair II*, Dirk the Daring – supreme warrior and all-round nice guy – rescues his girl Daphne from an evil wizard called Mordroc. In doing so he has to drop the nice-guy image and throw a few blinding punches at the old wiz.

Well, in *Lair III* you play Dirk again and the storyline follows in a similar vein, but this time Dirk's darling Daphne has been abducted by Mordroc's witch sister, Mordread. Dirk, being the kind of man he is, goes to the rescue again, chasing the evil kidnapper through Alice in Wonderland world. To survive, Dirk must face up to fights and terrible tricks being played by all the members of the Mad Hatter's Tea Party, the Queen of Hearts and Tweedle Dee and Tweedle Dum.



"Help! Help! My chip pan's on fire!" The beautiful busty damsel is most definitely in distress. Hang on, check that. By the current state of her boobs, she's nearly out of distress. (Think about it – it's a play on words; you know, a joke.)



"Once more with the pig-head, dear - but this time try to do it with feeling."



"Sorry, petal, but if you can't pirouette yourself, you need the elastic band."

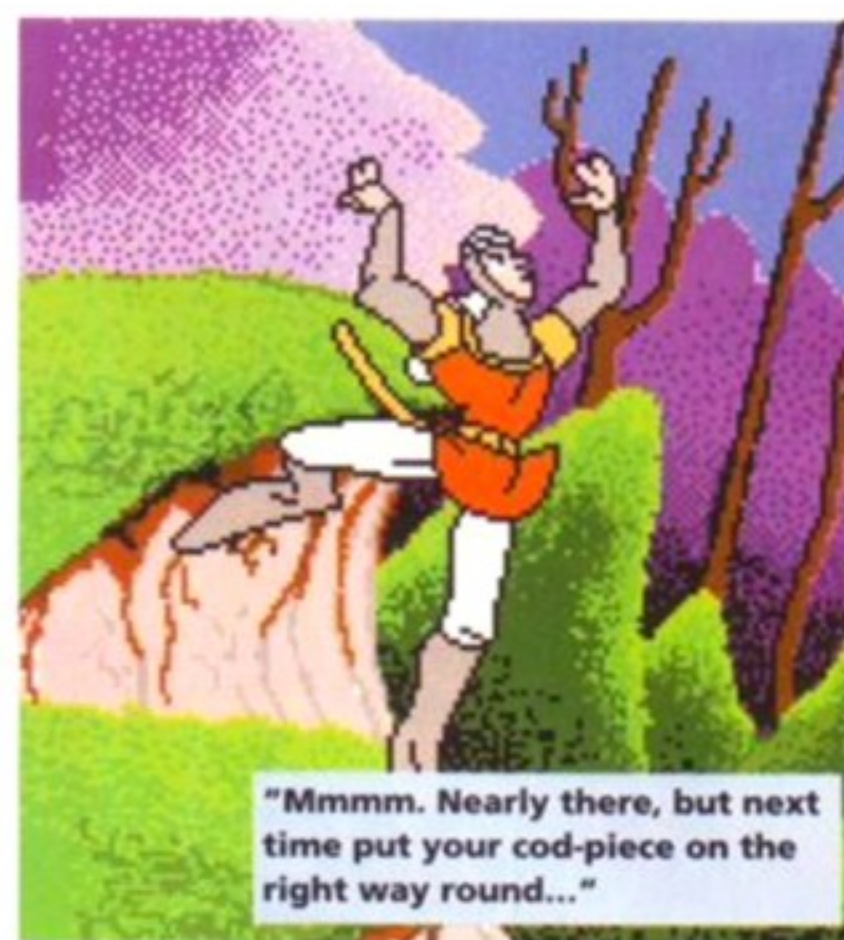

"Mmmm. Nearly there, but next time put your cod-piece on the right way round..."

Play then continues through several different time zones in which various famous people of the era are featured. Beethoven plays his Ninth Symphony while his vicious pet cat attacks you. Amusing scenes like this are accentuated by the expressions on the characters' faces.

Playable? Nah!

There is really only one thing that makes or breaks a computer game - and that's playability. Graphics and sound can't get you completely and utterly hooked. If a game doesn't make you want to forget about the rest of your life, then it just doesn't work in my book. All that *Dragon's Lair III* makes you do is long for the refuge of day-time TV - though it is more aesthetically pleasing than Richard and Judy.

The gameplay has the same old problem that dogged the previous versions: you have no direct control over Dirk. That's right - a few seconds of animation, you place Dirk in a potentially lethal situation, and you twitch the joystick in the vague hope that you choose the right direction to move Dirk out of danger. But which way? Left, right, up, down, or even a diagonal, who knows? The whole thing boils down to trial and error.

Charging through the scenes soon loses its appeal, and eventually you're stuck in a scene that seems to ignore all logical joystick movements. So you press fire, which doesn't work either. 'Timing is important', says the manual, which couldn't be more true. If you don't move at the correct time you can shove the joystick in the right direction until you are blue in the face without any effect whatsoever.

All that playing the game seems to be at the end of the day is a test of memory. Trying to remember 27 joystick moves in a row can be quite difficult. Thankfully, *Lair III* comes with a save-game option, which, although it's not the best of systems, does stop all the trudging through early levels again and again.

Third-time lucky?

Even with all these serious faults *Dragon's Lair III* does improve on versions I and II, even if it's only because it seems a tad longer. It's a bit crinkly, and generally quite sad. Good graphics and sound no more make a good game than appearances make a good cake. All the icing in the world couldn't save this release from the realms of mediocrity.

Huw Llewellyn

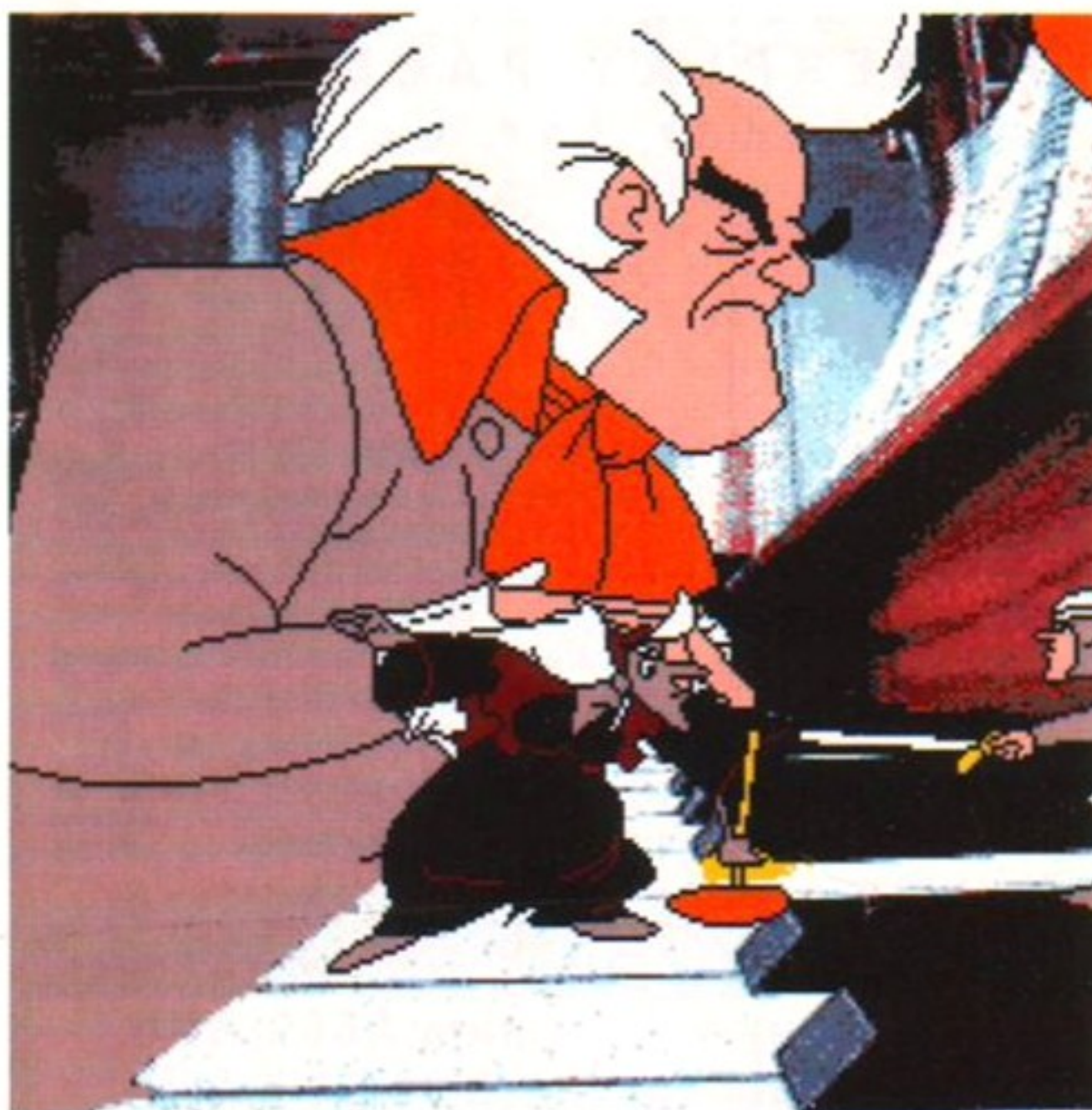
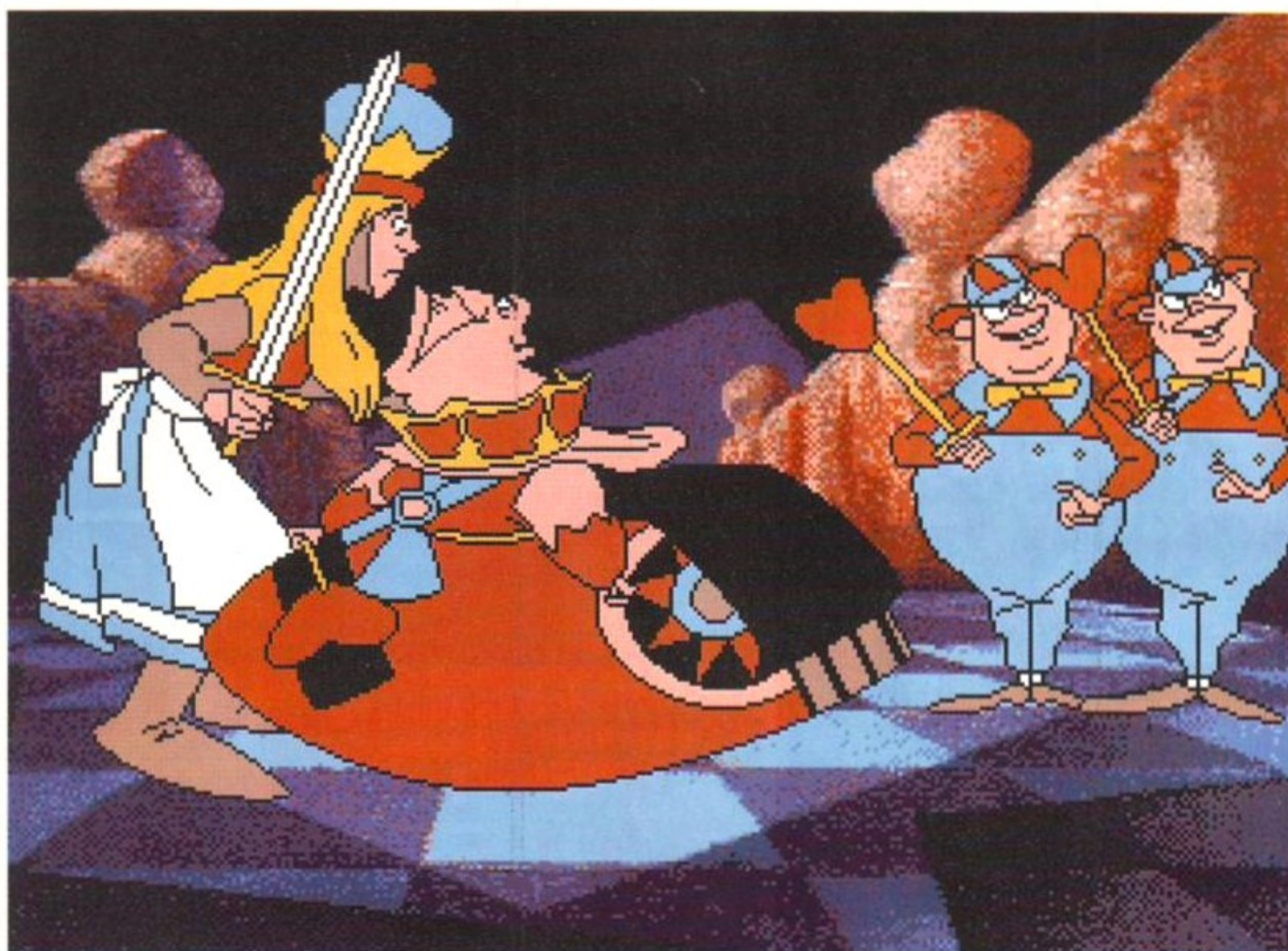

"Shhh - the maestro's decomposing." The indescribable thing tries to protect Beethoven while he's finishing that symphony.

"My liege, it appears that your disguise as a pretty young wench has worked a little too well. The Tweedle brothers over in the corner have just applied to your father for your hand in marriage."

Dragon's Lair Readysoft ■ £34.99

- Wonderful graphics and animation, but it's just a pretty face.
- Loads of excellent samples and speech throughout.
- What about the gameplay? Well, maybe in *Lair IV*...
- Nice, full-price graphic demo!
- Won't install on to a hard drive. Painful in the extreme.

AMIGA
(Verdict)
FORMAT

57%

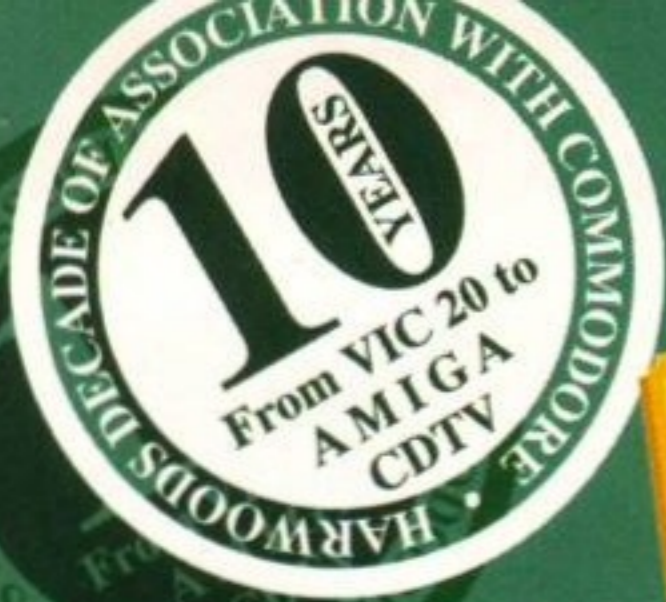

the latest AMIGA technology acknowledged experts

STOP PRESS
AMIGA A500+ PACKS
AVAILABLE IN LIMITED
QUANTITIES
Phone us for details

COMPARE OUR TOTAL PRICES
WHAT DO WE MEAN BY THIS?
We'll never try to disguise the total you'll pay by advertising low hardware prices and then when you call, try to add essentials such as cables, delivery and a proper after sales service... all at EXTRA COST! When deciding where to buy, compare our service, check out what the "Extras" really add to those attractive looking prices elsewhere... You'll soon see the REAL COST!

AMIGA 1200
32 BIT-2Mb
68020 PROCESSOR
the latest AMIGA...
FIRST NEW
AMIGA FOR 5 YEARS
AVAILABLE NOW!



All Harwoods new A600's are United Kingdom specification and include the following features... 1Mb. Disk Drive, 1Mb. RAM, 4096 Colours, Integral TV Modulator, Mouse, Workbench Disks, Manuals, PLUS all Leads - AND... FREE 1 YEARS 'IN HOME SERVICE'

TRUE 32 BIT POWER FOR EXCELLENT GRAPHICS.
The new A1200 is the Amiga of the 90's and the first true advancement to the already powerful Amiga range
Operating at 14MHz this is a revolution in power for the home market. With the new AGA Graphics chip set you have a truly remarkable colour palette of some 16.8 million colours allowing up to 256000 colours at any one time and... it runs the majority of existing software! JUST THINK OF THE IMMENSE POSSIBILITIES!
The A1200 is supplied with 2Mb RAM and has a full one years on site maintenance warranty FREE!
Available at Harwoods with an optional hard disk drive of 80Mb!

AMIGA 600 FLOPPY

DISK DRIVE VERSION

Available as either...

Pack with Deluxe Paint III and a MYSTERY game

But only whilst stocks last

at just... **£269.95**

OR AMIGA 600 FLOPPY

DISK DRIVE VERSION

WITH A NEW... **WICKED SOFTWARE**

- PUSHOVER
- SILLY PUTTY
- PROSE GRAND PRIX
- DELUXE PAINT III

at only... **£319.95**

AMIGA 600 20Mb HARD

HARD DRIVE VERSION

WITH A NEW... **EPIC SOFTWARE**

- EPIC • MYTH • ROME
- DELUXE PAINT III
- TRIVIAL PURSUIT
- MULTI LANGUAGE DICTIONARY

AMIGATEXT WORD PROCESSOR

If you want a DIFFERENT SIZE hard drive simply ask for the price! at only... **£459.95**

...Harwoods... EXCLUSIVE!

POWERPLAY THE GOLD 21 GAMES & WORD-PRO PACK

ADD our great GOLD POWERPLAY PACK to your order for only... £49.95

you get: A Superb High Quality Microswitched Competition Pro 5000 Joystick • 10 Essential 3.5" Blank Disks • Disk Storage Box • Tailored A600 Dust Cover and a High Quality Mat to enhance accuracy & protect your mouse **PLUS THE NEW MEGA-RELEASE GAME... ZOO!** and a FANTASTIC selection of TWENTY more great games: THESE TITLES ARE NOT PD BUT FULL PROFESSIONAL GAMES WHICH ORIGINALLY SOLD FOR PRICES OF BETWEEN £20 TO £30!!! Xenon 2 Megablast • Pinball Dreams • TV Sports Football • Hostages • Jumping Jackson • Striker • Bubble Plus • TinTin on the Moon • Bloodwych • Stir Crazy • Krypton Egg • Skychase • Eliminator • Purple Saturn Day • Safari Guns • Lombard RAC Rally • Captain Blood • Strike Force Harrier • Lancaster • Sky Fox II AND... Transwrite - Word Processor for the Amiga

With ALL THIS you won't need to buy anything more for ages!

why not buy your Amiga A600 with a FULL 2Mb. for just £39.95 extra

Floppy Drive Version ONLY... **£379.95** INC VAT
OR
80Mb Hard Drive Drive Version ONLY... **£679.95** INC VAT
If you want a DIFFERENT SIZE hard drive simply ask for the price!

0773 836781

*Finance Facilities Available, please contact us for your personal information pack

from the

0773 • 836781

If you want the POWER, then
look no further...

Harwoods have put together some great top of the range Amigas that will fit the bill for even the most demanding Amiga user. We've taken the powerful A1500 and tuned it into something extra special with a massive 120Mb. Hard Drive and 3Mb. of RAM, but if that's not powerful enough just look at the spec. of our Amiga A3000 & A4000 packs... and note the price. WE'VE GOT THE POWER!

EGOLD SERVICE
SEE PAGE 4 FOR FULL DETAILS

AMIGA 1500
TWIN FLOPPY DRIVES

THE LATEST
workbench
VERSION
2 OPERATING
system

But more than an ordinary 1500...

THE SPECIFICATION:

Fitted with a 120Mb. GVP Hard Drive

Twin 3.5" Floppies

3Mb RAM INSTALLED

PLUS SOME GREAT SOFTWARE...

•Toki• •Elf• •Puzznic•

•Home Accounts•

•Deluxe Paint III•

•The Works•

and the book
GET THE MOST
OUT OF YOUR
AMIGA 1992

£999.95
inc VAT

Phone for prices on other spec. A1500's

15" Monitor/Television

Superb definition Philips Monitor TV! Ideal for Amiga/CDTV Users giving for the first time true 80 column text Monitor Quality from a fully featured Teletext television set at a really AFFORDABLE price!

Just look at the extensive features...

- ★ Direct SCART connector for Amiga, CDTV, VCR or Satellite Receiver.
- ★ RGB/AD, Composite Video & Audio Inputs.
- ★ Full FastText Teletext Facilities [using external aerial socket]
- ★ Headphone Jack Socket
- ★ 2000 Character High Definition FST Tube, for Superb Text Quality and Graphics Displays
- ★ Supplied complete with Loop Aerial for indoor use
- ★ Infra-Red Remote Control
- ★ Free lead to your Amiga

GREAT VALUE only...
£239.95 Includes a FREE cable to your AMIGA

philips
monitors
CM8833/II
14" stereo COLOUR with a FREE cable & and dust cover + In-Home Service

NOW with a FREE game:
£219.95
LOTUS TURBO challenge 2



Add a CM 8833/II monitor or Monitor/TV when buying your Amiga and pay the low PHILIPS GOLD DISCOUNT prices to save even more!
[*only when purchased with an Amiga*]

philips
monitors
GOLD
monitor TV's
DISCOUNT
CM8833/II
£214.95*
MONITOR/TV
£229.95*

AMIGA 3000
2Mb

Latest Workbench 2
25MHz. - 2Mb. RAM
52Mb. Hard Drive
3.5" Floppy Drive
Including...

FINAL COPY II
and AMIGA VISION

ONLY **£1349.95**
52 Mb.

available with a 105 Mb. Hard Drive ONLY **£1529.95**
105 Mb.

free on site maintenance

AMIGA 3000 MONITORS
14" COLOUR SVGA
CBM1935 **£265.95**
.28" dot pitch
CBM1960 **£429.95**
Multiscan
.28" dot pitch

AMIGA 4000

Latest 25MHz 68040 CPU,
32 Bit architecture,
Built-in Maths Co-Processor,
2Mb Chip RAM, 4Mb Fast RAM,
Amiga DOS Version 3,
New AGA Graphics chip set,
40 or 120Mb Hard Drives.
Including FREE...

FINAL COPY II
and 1 Years on site warranty

with 6Mb & 120 Mb. Hard Drive ONLY **£2099.95**
40 Mb.

ONLY **£2129.95**
120 Mb.

EXTRA RAM UPGRADES

AMIGAS
A500 1/2Mb £29.95 A500+ 1Mb £39.95
A600 1Mb £44.95

All RAM expansions inc. Battery Backed Real Time Clock

SIMMS FOR GVP'S

HC8 & HD8 Drives add RAM in 2Mb. increments
1Mb Simm £27.95 4Mb Simm £99.95

32-Bit SIMM for GVP Accelerators [min. 2Mb. increments]
1Mb x 32Bit £52.95 4Mb x 32Bit £152.95

AMIGA
THE CDTV

PACK
MULTIMEDIA AT HOME
THE NEW AMIGA
CDTV MULTIMEDIA
PACKAGE HAS THE LOT
CDTV Player, Keyboard, Infrared
Mouse, 3.5" Disk Drive, Workbench
Disks, Welcome CD, & Remote

ONLY **£479.95**
INC VAT

ENTRY CDTV SYSTEM
MULTIMEDIA
CDTV player with Welcome
Disk, Remote Controller,
Hutchinsons Encyclopaedia
& the great game Lemmings
£379.95

CD ROM
DRIVE for A500+
use music cd's & CDTV
titles on your A500 Plus
Only... **£329.95**

ALL PRICES ARE INCLUSIVE OF

VAT AT 17.5%

GORDON HARWOOD
Computers



the extensive range of peripherals and software

EXPAND your system... and get MORE from your AMIGA

If you've got an Amiga why not get **THE MOST** from it....

because it's so easy to attach our add-ons and use some great software, you can quickly get to grips with anything. From Graphic Design, Desk Top Publishing, Video Mixing and Music Composition to many useful business programs such as Word Processors, Accounts, Spreadsheets, Databases etc. You can add advanced technology such as fast Hard Disk Drives for quick access to data, Genlocks & Video Digitisers to import and manipulate images, Sound Samplers to help you with your musical talents and Printers to enable output of your 'your creations'. With a whole lot more available, you too can...

EXPAND YOUR AMIGA - EASILY!

AMIGA PRINTERS

DOT MATRIX
INKJETS AND
LASERS

All our printers are supplied for immediate use including a cable, paper and labels **FREE OF CHARGE**.
Dot matrix models come with a tailored dust cover. We also include our specific Amiga driver disks for Citizens, Stars and Canons. ALL Citizens have a 2Year Warranty
Please call for prices on any models not listed

9 PRINTERS

PIN 9 PIN DOT MATRIX

- STAR LC 20 MONO £134.95
- NEW STAR LC 100 COLOUR £164.95
- STAR LC 200 COLOUR £194.95
- CITIZEN 120D+ MONO £124.95
- CITIZEN SWIFT 9 COLOUR £179.95

24 PRINTERS

PIN 24 PIN DOT MATRIX

- STAR LC 24/200 COLOUR £269.95
- XB 24/200 COLOUR £369.95
- CITIZEN SWIFT 200 MONO £209.95
- SWIFT 200 COLOUR £239.95
- SWIFT 240 MONO £249.95
- SWIFT 240 COLOUR £269.95

HIGH RES PRINTERS

HIGH RESOLUTION

- STAR SJ48 INKJET £209.95
- CANON BJ10ex INKJET £224.95
- CANON BJ20ex INKJET including automatic sheet feeder £319.95
- HP DESKJET 500 MONO £369.95
- HP DESKJET 550 COLOUR...NEW £649.95
- HP PAINTJET COLOUR £679.95
- STAR LASERS FROM... £749.95

GENUINE PRINTER ACCESSORIES CONSUMABLES AND UPGRADES

PRINTER	PRINTER TYPE	BLACK RIBBON	BLACK RIBBON 'SIX PACK'	COLOUR RIBBON	COLOUR RIBBON 'SIX PACK'
CITIZEN 120D+	BLACK ONLY	£4.75	£22.95	N/A	N/A
CITIZEN 124	BLACK ONLY	£4.75	£22.95	N/A	N/A
CITIZEN SWIFT 9	BLACK/COLOUR	£4.75	£22.95	£16.45	£94.95
SWIFT 24/24E/224	BLACK/COLOUR	£4.75	£22.95	£16.45	£94.95
STAR LC10/20/100	BLACK/COLOUR	£4.45	£23.95	£5.95	£34.95
STAR LC200	BLACK/COLOUR	£5.95 ZX9	£32.95 ZX9	£12.45 ZX9CL	£64.95 ZX9CL
STAR LC24/200	BLACK/COLOUR	£6.95 Z24	£39.95 Z24	£12.95 X24CL	£69.95 X24CL
STAR XB RANGE	BLACK/COLOUR	£8.95 Z24	£49.95 Z24	£14.95 X24CL	£74.95 X24CL
STAR SJ48 INK CARTRIDGE	BLACK ONLY	Also compatible with Apple Stylewriter and Canon BJ10ex Bubblejet			£15.95ea.

- Hewlett Packard Original Consumables**
- DESKJET 500... Black Ink Cartridge £21.95 [Double Life]
 - Colour Ink Cartridge [Std] £25.95
 - PAINTJET... Black Ink Cartridge £22.95
 - Colour Ink Cartridge £24.95
 - Single Sheet Paper £20.95
 - Z-Fold Paper £18.95
 - Transparency Film: [Pack of 50 Sheets] £52.95

- Citizen Accessories:**
- 80 Column 9/24 Pin £37.95
 - Printer Colour Kit [ALL models except the Citizen 124 model] £13.95
 - 32K RAM Expansion [24Pin Citizens except 200/240] £19.95
 - 32K RAM Expansion [Citizen 200/240] £32.95
 - 128K RAM Expansion [Citizen 200/240] £32.95

AUTOMATIC SHEET FEEDERS:
ALL Star & Citizen 80Column models
Only...£69.95
[please state model when ordering]

Please phone for items not listed

AMIGA HARD DRIVES

- 20Mb. Only... **£199.95**
 - 60Mb. Only... **£299.95**
 - 80Mb. Only... **£349.95**
- Prices include courier collection & return of your Amiga, installation & a full 12month Gold Warranty for both your drive and Amiga.
600HD Owners, trade up your 20Mb. Hard Drive! Phone for details.

HARD DISK DRIVES

with 2yrs warranty

A500 and PLUS Simply plug in to the Amiga sideport

HD8 Hard Drives

RAM	80Mb.	120Mb.
0Mb.	£369.95	£429.95
2Mb.	£419.95	£479.95
4Mb.	£469.95	£529.95
8Mb.	£569.95	£629.95

A530 Combined Hard Drive and 68030 Accelerator

RAM	80Mb.	120Mb.
1Mb.	£649.95	£719.95
2Mb.	£699.95	£779.95
4Mb.	£799.95	£879.95
8Mb.	£949.95	£1009.95

68882 Maths floating point unit for A530's £219.95

AMIGA 1500 2000 internal HARD DISK DRIVE

HC8 Hard Drives

RAM	80Mb.	120Mb.
0Mb.	£329.95	£399.95
2Mb.	£379.95	£449.95
4Mb.	£429.95	£499.95
8Mb.	£529.95	£599.95

NB!!! Hard drives fitted with memory may fluctuate in price due to the \$/£ exchange rates. Please confirm prices when ordering.

CUMANA 3.5" floppy drive
with free disk head cleaner
-LONG CONNECTING-CABLE - THROUGHPORT -
£54.95

0773 836781

*Finance Facilities Available, please contact us for your personal information pack

AMIGA

0773 836781

AMIGA software

Listed below is a sample from our vast range of software at competitive prices. If you need a product not listed simply phone us and we will be delighted to quote for your requirements.

word processors/publishing

Pen Pal V1.4	£49.95
Final Copy II V2.0	£99.95
Kindwords 3	£39.95
Wordworth V1.1	£109.95
Transwrite	£29.95
Prowrite 3.3	£79.95
Pagestream V2.2	£129.95
Professional PageV3.0	£129.95
Pagesetter II	£44.95
SoftClips Clip Art...	
Classic Clip Art	£29.95
People Clip Art	£29.95
Collectors Clip Art	£29.95
Animal Clip Art	£29.95
Electric Thesaurus	£29.95

integrated titles

Mini Office	£39.95
Gold Disk Office	£59.95

databases

Homebase	£19.95
Superbase 2 Personal	£29.95
Gallery Pictorial Slide Show/DB	£39.95

CAD & structured drawing

Intro CAD Plus	£79.95
X-CAD 3000	£269.95
Professional Draw 3	£89.95

video

Scala 500	£79.95
Scala Professional	£199.95
Broadcast Titler 2	£179.95
Pro Video Post	£169.95
Video Studio V3	£119.95

animation and graphics

Deluxe Paint 4	£64.95
Real 3D Professional Turbo	£249.95
Art Department Professional V2	£144.95
DCTV Composite Video 24-Bit Graphics System (PAL)	£379.95
Imagine 2.0	£189.95

utilities & development

Disk Master V2	£44.95
Quarterback V5	£44.95
Quarterback Tools	£54.95
Dos-2-Dos	£29.95
Easy Amos	£24.95
Amos The Creator	£36.95
Amos Compiler	£23.95
Amos 3D	£25.95
Amos Professional	£49.95
New SAS Lattice C V6	£219.95
Devpac 3	£54.95
Directory Opus	£27.95

miscellaneous

GB Route Plus	£39.95
Professional Calc	£124.95

games & entertainment

Phone for access to our massive competitively priced range now!

AMIGA + - x ÷ a b c software

FOR EDUCATION	easy learning for all ages right up to GCSE 'A' standards
micro maths - to GCSE standards	£18.95
micro english - to GCSE standards	£18.95
micro french - to GCSE standards	£18.95
micro german - to GCSE standards	£18.95
primary maths - 3to12's	£18.95
mega maths - A level	£19.95
reading and writing course - over 3's	£18.95
compendium six	£29.95
fun school 4 software: choose - under 5's, 5to7's or 7to11's, only...	£19.95 each
ADI titles 11to12: english	£18.95
maths	£18.95
french	£18.95
ADI titles 12to13: english	£18.95
maths	£18.95
french	£18.95
first shapes - 3to8	£12.95
puzzle story book - 3to8	£19.95
dinosaur discovery kit - 3to8	£19.95
first letters and words - 3to8	£12.95
NEW...Childs Play Activity Centre & Word Processor with SPEECH, 2to12yrs	£24.95

AMIGA BOOKSHOP

Amiga for Beginners	£12.95
Getting the most from your Amiga	£13.95
Amiga Machine Language	£14.95
Amiga DOS inside and out	£21.95
Amiga Hardware reference manual	£21.95
Amiga C for beginners	£13.95
Other Books: ...call us with your requirements	

AMIGA accessories

Digiview Media Station	£134.95
Colour Pic Plus	£679.95
Super Pic	£579.95
Rombo Vidi 12	£89.95
Amas 2 Sound Sampler & Midi Interface inc. Microphone	£79.95
Audio Engineer Plus	
Sound Sampler	£179.95
Technosound Turbo Sound Sampler	£29.95
Miracle keyboard music teaching system for the Amiga	£299.95
Music X (full version 1.1 whilst stocks last)	£19.95
Midi interface 5 port with two cables	£24.95
Super JAM	£84.95
Bars & Pipes Professional	£219.95
ZYFI Stereo Speakers with a separate power supply	£39.95
Power Mono Hand Held Scanner	£98.95
Power Colour Hand Held Scanner	£239.95
Sharp JX 100 Colour Flatbed [A6 Paper size]	£549.95
ProGen - Perfect high quality entry level true video signal genlock	£64.95
Rocgen Plus	£119.95
Multi connection cable kit for all genlocks	£14.95
HQ Microswitched mouse	£13.95
HQ Microswitched mouse inc. Mouse Mat & Holder	£19.95
Naksha Microswitched mouse with Mat & Holder	£21.95
High Quality microswitched Optical mouse	£28.95
HQ Microswitched Trackball	£29.95
Superb Automatic Mouse and Joystick Switcher	£17.95

AMIGA MICE

KCS Powerboard Plus 512K RAM [Please state A500 or plus when ordering - not A600 compatible] Now supports most hard drives! supplied without DOS £184.95 supplied with DOS 4.01 £214.95 1500/2000/3000 adaptor £69.95 GVP 286 PC emulator card for A500 HD8/530 (no DOS). Simply plugs into your GVP drive £189.95

AMIGA MONITORS

Premier Control Centre & Monitor Plinth with shelf: For Amiga A500 £39.95 For Amiga A600 £34.95 Zipstick autofire £11.95 Competition Pro-Star autofire, burstfire & slow motion £13.95 Full range of Quickjoy and other makes stocked - call for prices

BLANK 10 Sony 3.5" DS DD	£8.95
50 Sony 3.5" DS DD	£34.95
Certified Bulk Disks with labels: 10 with library case	£6.95
50 Disks - only...	£24.95
250 Disks - only...	£79.95
3.5" Disk Head Cleaner essential for reliable loading	£2.95

COMPARE OUR GOLD SERVICE

Before you choose from whom to purchase, please phone us. We are always happy to discuss your requirements and answer any queries you may have. And... remember Harwoods have always provided THE BEST service in the industry...

FREE GOLD SERVICE: Any computer, monitor or printer that requires service in the first year is collected FREE OF CHARGE (UK Mainland only). Remember at Harwoods we charge no more for this GOLD service. The fastest turnaround possible is GUARANTEED by our OWN SERVICE ENGINEERS. Many items have In-Home Warranties - **TECHNICAL SUPPORT:** You will be given our Exclusive Technical Support Phone Number to call should you require any help or advice on any aspect of the system you have purchased. **MINIMUM 12 MONTH HARDWARE WARRANTY:** Items proving faulty within 30 days of purchase are replaced with NEW UNITS unless otherwise stated. For the guarantee period, warranty service will be completely FREE OF CHARGE [some items are 2 yr warranty]. **YOUR SYSTEM READY TO GO:** All main hardware products come with mains plugs and leads - just connect up and use straight away.

How to contact us...
BY PHONE: Phone our Order Hotline with your Access, Visa, Mastercard Switch or Lombard Creditcharge Card quoting number & expiry date (Most Dixons, Currys, NASCR and other 'store' cards are Lombard Creditcharge and are happily accepted by us).

BY POST: Make cheques, bankers building society drafts or postal orders payable to GORDON HARWOOD COMPUTERS. (Personal/business cheques take 7days to clear from day of receipt whereupon your order will be despatched). Please send Name, Address, and most importantly if possible, a Daytime Telephone Number along with your order requirements. Please check you are ordering from our latest advertisement before posting (phone if you require confirmation). Please remember that for example many September publications appear during August, etc., therefore prices you see may have changed (either up or down!).

EXPORT: Most items are available at TAX FREE PRICES to non UK residents and service personnel. Please contact us for confirmation of export prices before ordering.

FREE DELIVERY: by Parcel Force, UK Mainland only. OR: **SPEEDY NEXT WORKING DAY COURIER SERVICE.** Add just £6.95 per major item for guaranteed delivery (or £7.50 for Saturday delivery); UK Mainland most regions. (Despatch normally on day of order or payment clearance).

All listed prices are what YOU PAY, and there are NO HIDDEN EXTRAS. VAT and postage are included, and prices are correct at time of going to press (Pack details may vary from time to time). Offers and Services are subject to availability and to being the latest advertised products, packs and prices. Please note goods are not supplied on a trial basis. E&OE.

VISIT OUR SPACIOUS SHOWROOM: Why not take a trip out to visit us and see our full advertised range, and more, available at the SAME COMPETITIVE PRICES. (Please see opening times) There's plenty of FREE parking nearby too!

How to find us...

OPENING TIMES
 9.00 until 5.00 Monday to Saturday
 Wednesdays - 9.00 until 1.00

BY RAIL - ALFRETON MAINLINE STATION IS CONVENIENTLY RIGHT IN OUR TOWN

GORDON HARWOOD Computers

Enquiries & Order Line:
0773 836781

Finance Facilities Available*
 *Please phone us for information, your personal application pack and full written details.

GORDON HARWOOD COMPUTERS
 DEPARTMENT AMF /H3, NEW STREET,
 ALFRETON, DERBYSHIRE. DE5 7BP
 TEL: 0773 836781 FAX: 0773 831040

AMIGA POWER ...The Video

AMIGA POWER

TIPS

Played and presented by
Matthew Squires

IN ASSOCIATION WITH
AMIGA
FORMAT MAGAZINE

The video that's packed with
hints, tips, and playing guides
for all Amiga games players!

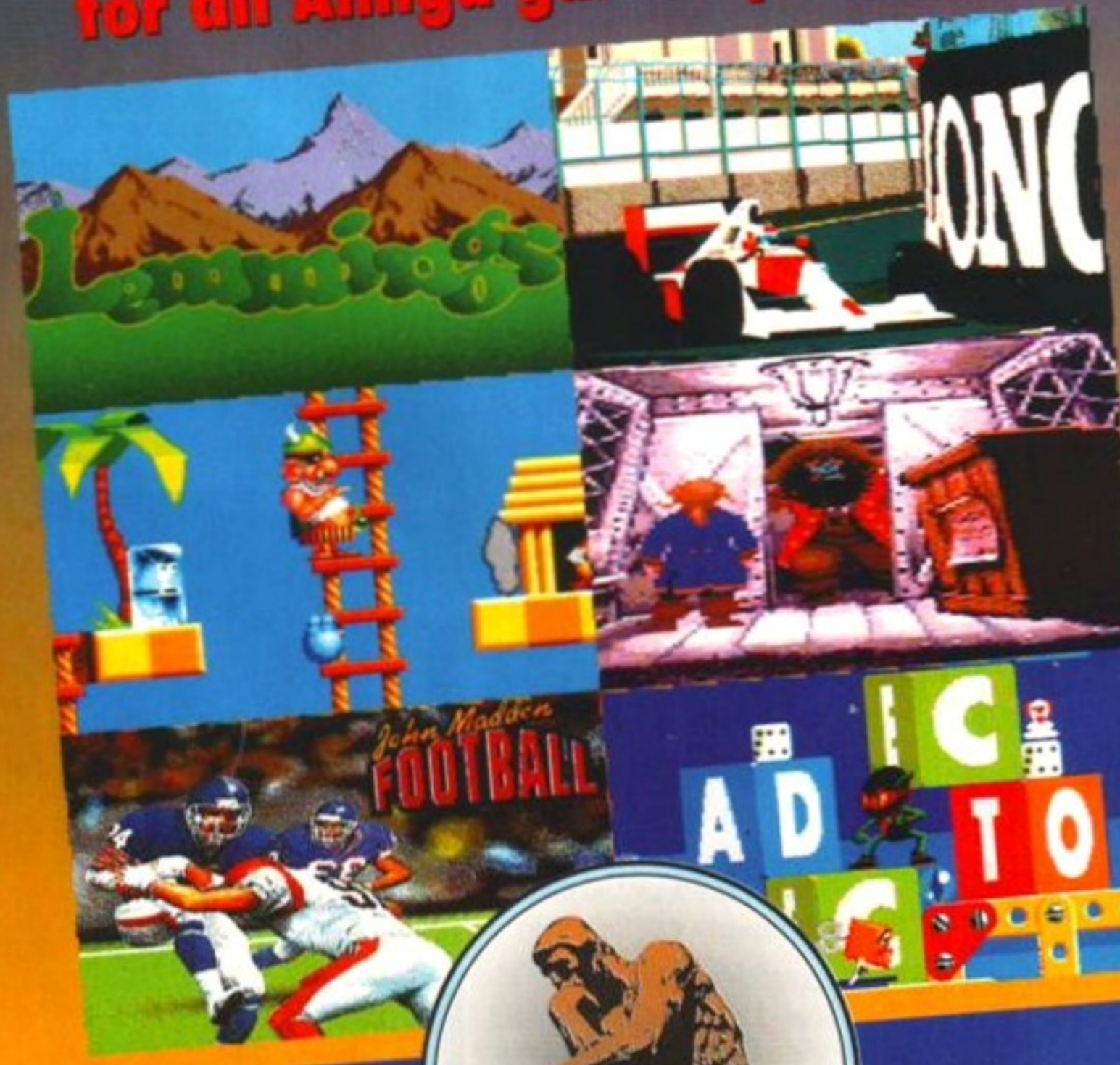

WONDERLAND

**A Power
packed hour of
sensational tips
from Britain's
biggest
selling Amiga
games
magazine.**

**At only £9.99,
the AMIGA
POWER Tips
Video is
available
from
Woolworths,
WH Smith,
and all good
video and
computer
stockists.**

No joystick can accurately replicate the feel of a real steering wheel. But that's what Logic 3 have tried to do with their new FreeWheel joystick.

The FreeWheel Analogue, like its digital cousin (see box below), is a small, solid plastic wheel that wouldn't look out of place on a boy-racer's Mini Cooper. It has two small fire-buttons that run flush to the inside at the ten and two o'clock positions on the wheel. To use it, all you have to do is plug the lead in the second joystick port on your Amiga.

The weird thing is that unlike previous joystick steering devices, the FreeWheel isn't bolted down to your desk – it's completely hand-held. This feels odd, because even in your car, the wheel doesn't just hang there – it's bolted to the steering mechanics – and there are only two directions you can move it. That's the point; it steers, leaving the stoppy-starty bits to the accelerator and brake pedals.

Maybe this is how it is for Ferrari and Ford, but Logic 3 have built these self-same, stoppy-starty functions into the steering wheel. The tilt switches not only sense the tipping to the left and right, but they also look out for motion forwards and backwards. It's these forward/backward motions that control acceleration and breaking when driving.

It's the combination of the tilting, and the lack of a solid axis on which to pivot, that makes your first few miles so disconcerting. To accelerate in a corner, you not only have to tip the joystick strongly left or right (a natural driving instinct), but you also have to push the FreeWheel forward (an unnatural driving instinct), which takes a while to get used to.

Basic instincts

The FreeWheel Analogue is a proportional control device. So the steering really does make sense, and it's possible to slowly nudge a car left or right by a few degrees, exactly as you would with a 'real' car. It's not totally convincing as there's no lock – half a rotation of the wheel is about all it will understand – but it's easier to translate your normal driving instincts to a more sensitive steering wheel than it is to a small stick.

Is it a must-have joystick though, or merely a fancy widget? This depends on which software you use it with. *Formula One Grand*

The FreeWheel Analogue joystick: wheel see if it drives you round the bend, or steers you to greater things.



FreeWheel

Prix, the game at which the FreeWheel is primarily aimed, has an excellent auto-braking mode. This slows the car down to 'safe' speed for every corner and was included for rookie racers with a need for speed. This option comes into its own with the FreeWheel. Suddenly, the need to crank the hands back as you try to slow down is removed, and then you can concentrate on maintaining the racing line.

Racing with *FIGP* shows off the true potential of the FreeWheel. Finding the right line is suddenly easier, and precise course correction becomes possible. It's great to be able to control a car as nature intended, rather than have to relate odd control skills to an unrealistic joystick system.

Even in *FIGP* however, fundamental problems plague the FreeWheel. The unfixed nature of the pivot is fine when you're doing well, but if you break concentration, all hell

breaks loose, and valuable time is lost as you have to re-orientate yourself and the wheel.

Then there's the desire *FIGP* fans have to develop their skills, and strip away the driver aids. But if you take the auto-brake out of the equation – one of the six help modes – then the FreeWheel becomes a hindrance, because you have to twist it this way and that, while trying to keep it within the calibration limits.

Speed thrills

As an extra for *FIGP*, it's ideal for those hardened-disk drivers who've fought their way through a full season, and who still want more. Whole new sets of skills have to be mastered, forcing you to re-learn a game you may think you already know inside out.

The FreeWheel Analog, like any proportional device, suffers from a scarcity of suitable games. With the software that suits the system, it enables you to wreak high-speed havoc in a most excellent style. But unless you've a huge collection of analogue-compatible sims that hanker for that extra smidgen of realism, then the FreeWheel is more likely to become a dust-trap than a speed-trap.

Trenton Webb

FREEWHEEL DIGITAL ■ £29.95



Formula One Grand Prix doesn't benefit from the FreeWheel Digital, but does from the Analog version.

The FreeWheel Digital looks and feels like its proportional sibling; in fact there are only two ways to tell them apart – the badge on the centre of the wheel, or by using the thing. Overlooking obvious titular differences, it is in

the playing of games where the Digital really lets itself down.

This wheel too, works by being tipped sideways, forwards and back. Unlike its Analogue counterpart, though, the motion lacks subtlety. One flip of the wheel, and you're either gunning full out, stamping on the brakes, or on full-lock in a corner. This is not realistic or easy to control, and can prove dangerous to your high-score potential.

With the Analogue stick, the software usually enables you to calibrate the wheel to suit your own driving style. This effectively causes the car to over or under-steer depending on how much of

a hard time you give the wheel. But the Digital stick is only set up in one way and that's it. So, if that set up doesn't suit you, then that's tough.

The FreeWheel Digital does enable you to race reasonably well, but it doesn't really do anything to promote playability. It is simply another feature to contend with in your bid for the fastest lap. It doesn't make the driving any better, just different. And for the money, different just isn't good enough.



52%



69%

AMEAGRE PRICES FOR AMIGA USERS

10 Great Games	20.95	Doodlebug	17.95	Legend of Kyrandia (1Mb)	23.95	Robin Hood	17.95
3D Construction Kit 2	33.95	Double Dragon I	7.95	Leisure Suit Larry 5 (1Mb)	23.95	Robocod	17.95
3D Pool	7.95	Double Dragon II	7.95	Lemmings (Original)	17.95	Robocop I	6.96
4 Wheel Drive (Comp)	20.95	Double Dragon III	17.95	Lemmings 2	20.95	Robocop II	15.96
A10 Tank Killer (1Mb)	23.95	Dragons Lair III - The Curse of Mordred	20.95	Lemmings Double Pack	20.95	Robocop III	17.95
Action Masters (Comp)	20.95	Dreadnoughts	25.99	Lemmings Levels (Add-On version)	13.95	Roboport	20.95
Action Pack (Comp)	19.95	Dreadnoughts - Bismarck	12.95	Lemmings Levels (Stand Alone)	17.95	Rodland	17.95
Addams Family	17.95	Dreadnoughts - Ironclads	12.95	Lethal Weapon	17.95	Rolling Ronny (N+)	17.95
AD1 English (11-12)	17.95	Dream Team	17.95	Let's Spell At Home	14.95	Rugby - The World Cup	17.95
AD1 English (12-13)	17.95	Dune (1Mb)	20.95	Let's Spell At The Shops	14.95	Sabre Team (1Mb)	17.95
AD1 English (13-14)	17.95	Dungeon Master/Chaos Strikes Back (1Mb)	20.95	Life & Death	12.95	Savage	7.95
AD1 French (14-15)	17.95	Dyna Blaster	20.95	Linker Collection	13.95	Scrabble	19.95
AD1 Maths (11-12)	17.95	Easy Amos (1Mb)	25.99	Links (1Mb)	23.95	Secret of Monkey Island (1Mb, N+)	17.95
Advanced Destroyer Sim	7.95	Emlyn Hughes International Soccer	7.95	Links - Firestone	12.95	Secret of Monkey Island II (1Mb)	26.95
Advanced Fruit Machine	5.95	Epic (1Mb, N600)	20.95	Little Puff (N+)	6.96	Secret of Silver Blades (1Mb)	20.95
Advantage Tennis	17.95	Erik	6.96	Liverpool Football	17.95	Sensible Soccer 92/93	17.95
Adventurers	17.95	Escape from Planet of Robot Monsters	6.96	Locomotion	17.95	Shadow of the Beast III	20.95
After Burner	6.96	Espana - The Games 92	20.95	Lombard RAC Rally	6.96	Shadow Warriors	6.96
Agony	17.95	Euro Football Champ	17.95	Lord of the Rings	17.95	Shadowlands	20.95
Air Bucks (1Mb)	17.95	European Championships 1992	17.95	Lotus Spirit Turbo Challenge	7.95	Shadowlands (1Mb)	17.95
Air Combat Aces (N+)	20.95	Eye of the Beholder I (1Mb)	20.95	Lotus III - The Ultimate Challenge	17.95	Sherman M4 (N600)	6.96
Air Sea Supremacy (Comp)	20.95	Eye of the Beholder II (1Mb)	23.95	Lotus Turbo Challenge II	17.95	Shoe People	7.95
Air Support	20.95	F-16 Combat Pilot	7.95	Lure of the Temptress (1Mb)	20.95	Shoo! Em Up Construction Kit	7.95
Air-Land-Sea (Comp) (688 AS N+)	23.95	P-19 Stealth Fighter	20.95	M1 Tank Platoon	20.95	Shopping Basket	13.95
Alcatraz	17.95	P-29 Retaliator (N+)	17.95	Magi Maths (4-8)	19.95	Shuttle (1Mb)	20.95
Allen 3	20.95	Face off - Ice Hockey	17.95	Magi Storybook (1Mb)	20.95	Silent Service II (1Mb)	23.95
Allen Breed - Special Edition 92 (1Mb)	8.95	Falcon	11.95	Magi Worlds	17.95	Silkworms	7.95
Altered Beast	6.96	Falcon - Counterstrike Data Disk	7.95	Magiworld Dizzy	6.96	Sim Ant	23.95
Alvin Puzzles	13.95	Falcon - Firefight Data Disk	7.95	Manchester United	7.95	Sim City	18.95
Amberstar (1Mb, N600)	20.95	Fantastic Worlds (Comp)	23.95	Manchester United Europe	17.95	Sim City - Architecture 1	7.95
Amos 3D	23.95	Fantasy World Dizzy (N+)	6.96	Match of the Day	17.95	Sim City - Architecture 2	7.95
Amos Compiler	20.95	Fascination	20.95	Maths Adventure (6-14)	19.95	Sim City - Terrain Editor	7.95
Amos Professional (1Mb)	46.95	Fast Food (N+)	5.95	Medonald Land	17.95	Sim City/Populous	20.95
Amos the Creator	33.95	Fire and Ice	17.95	Mega Mix (Comp)	20.95	Sim Earth	23.95
Anarchy	7.95	Fire Force	17.95	Mega Sports	17.95	Ski or Die	8.95
Another World	17.95	First Division Manager	6.96	Mega Twins	17.95	Sly Spy	6.96
Answer Back Junior Quiz (6-11)	15.99	Flight of the Intruder	12.95	Mega-Lo-Mania/First Samurai	20.95	Smash TV	6.96
Answer Back Senior Quiz (12-Adult)	15.99	Flimbo's Quest	7.95	MegaFortress (1Mb)	20.95	Snow Bros	17.95
Answer Back - World Geography (11-AD)	8.95	Floor 13 (1Mb)	20.95	Megatraveller 1 (1Mb)	20.95	Soccer Pinball	6.96
Apidya	17.95	Football Crazy (Comp)	17.95	Megatraveller 2 (1Mb)	20.95	Soccer Stars (Comp)	17.95
Aquatic Games	17.95	Football Director 2 (1Mb, N+)	17.95	Mercenary 3	17.95	Sooty & Sweep	6.96
Aquaventura	17.95	Formula 1 Grand Prix (1Mb)	23.95	Merlin's Maths (7-11)	17.95	Space Ace II	23.95
Archer Maclean's Pool	17.95	French Mistress	15.99	Micro English (8-GCSE)	18.95	Space Crusade	17.95
Arkanoid II - Revenge of Doh	6.96	Pun School 2 (6-8)	6.96	Micro English (8-GCSE)	18.95	Space Gun	17.95
Armour Geddon 2	20.95	Pun School 2 (over 8)	6.96	Micro French (Beginners - GCSE)	18.95	Spanish Tutor	15.99
Arsenal - The Computer Game	17.95	Pun School 2 (under 6)	6.96	Micro German (Beginners, GCSE, Business)	18.95	Special Forces (1Mb, N600)	23.95
Assassin (1Mb)	17.95	Pun School 3 (5-7)	17.95	Micro Maths (11-GCSE)	18.95	Spelling Fair (7-13)	17.95
Award Winners (Comp)	17.95	Pun School 4 (5-7)	17.95	Microprose Golf (1Mb)	23.95	ST Dragon	6.96
Bane of the Cosmic Forge (1Mb)	25.99	Pun School 4 (7-11)	17.95	Microprose Soccer	6.96	Starflight 2	17.95
Barbarian I	6.96	Pun School 4 (Under 5s)	17.95	Midnight Resistance (N+)	6.96	Starfighter II	7.95
Barbarian II (Budget)	6.96	Future Wars	10.95	Mig 29 Soviet Fighter (N+)	5.95	Steg the Slug	6.96
Barbarian II (Pygnosis)	17.95	G-U-Lo	17.95	Might and Magic 3 (1Mb)	23.95	Stellar 7	17.95
Bards Tale 3	8.95	Gauntlet II	6.96	Mini Office (1Mb)	49.95	Storm Master	20.95
Bards Tale Trilogy	23.95	Gauntlet III	17.95	Monty Python	7.95	Strategy Masters	21.95
Bat 2	23.95	German Master	15.99	Moonstone (1Mb)	20.95	Street Fighter (N+)	7.95
Batman - Caped Crusader	6.96	Ghostbusters 2 (N+)	6.96	Moonwalker (N+)	6.96	Street Fighter 2	19.95
Batman The Movie	6.96	Ghouls 'N' Ghosts	6.96	Motorhead	12.95	Strider	6.96
Battle Chess	8.95	Global Effect (1Mb)	20.95	Myth	17.95	Striker (1Mb)	17.95
Battle Chess II (N+)	17.95	Gnome Alone	17.95	Narc	6.96	Striker Manager	7.95
Battle Isle	20.95	Go For Gold	7.95	Narco Police	6.96	Stunt Car Racer	6.96
Battle Isle - Scenario Disk Vol 1	13.95	Goblins	17.95	Neighbours	17.95	Supaplex	6.96
Battle of Britain	20.95	Goblins 2	20.95	New Zealand Story (N+)	6.96	Super Frog (1Mb)	17.95
Battle Toads	17.95	Golden Axe	17.95	Nigel Mansell's World Championship	20.95	Super Monaco G.P.	7.95
Battlehawks 1942	12.95	Graham Taylor's Soccer (1Mb)	7.95	Ninja Collection	13.95	Super Off Road	7.95
B C Kid	17.95	Grandstand (Comp) (N+)	9.99	Nitro	7.95	Super Sim Pack (Comp)	18.95
Beach Volley	6.96	Gunship 2000	23.95	No Greater Glory	23.95	Super Space Invaders (N+)	17.95
Beastbusters	17.95	Guy Spy	20.95	No Second Prize (N600)	17.95	Super Tetris (1Mb)	20.95
Better Maths (12-16)	19.95	Harlequin	17.95	Noddy's Playtime (1Mb)	17.95	Supercars	6.96
Better Spelling (8 Adult)	19.95	Harpoon - Battle Set 4	11.95	North & South	6.96	Supercars II	7.95
Big Run	17.95	Harpoon v1.2.1	23.95	Omar Sharif's Bridge (1Mb)	23.95	Superfighters (Comp)	17.95
Bill's Tomato Game	20.95	Harrier Assault (1Mb)	23.95	Operation Combat	7.95	Superski 2	17.95
Birds of Prey (1Mb)	23.95	Head Over Heels	6.96	Operation Thunderbolt	6.96	Suspicious Cargo	17.95
Bitmap Brothers - Volume 1	17.95	Head to Head (Comp)	23.95	Operation Wolf (N+)	6.96	Switchblade II	7.95
Bitmap Brothers - Volume 2	17.95	Heimdall (1Mb)	23.95	Oriental Games	7.95	Swir	7.95
Black Crypt (1Mb, N+)	17.95	Henrietta's book of Spells (7-14)	17.95	Outlander	20.95	Sword of Honour	17.95
Body Blows (1Mb)	17.95	Heroes of the Lance	6.96	Outrun (N+)	6.96	Tennis Cup 2	17.95
Brain Blaster	6.96	Heroquest - Data Disk	11.95	Pacific Islands	20.95	Test Drive II Collection (N+)	20.95
Bubble Bobble (N+)	6.96	Heroquest - Twin Pack	20.95	Paint and Create (Over 5s)	17.95	The Manager (1Mb)	20.95
Bubble Dizzy	6.96	Heroquest 2	17.95	Paint Pot 2	13.95	Thomas the Tank Engine	6.96
Bunny Bucks	17.95	Hatchers Guide to the Galaxy	7.95	Paladin II (1Mb)	20.95	Thunderhawk	20.95
Cadaver - The Payoff	11.95	Home Accounts 1	20.95	Pang	6.96	Tip Off	17.95
Caesar	20.95	Home Accounts 2	39.95	Panza Kick Boxing	7.95	Titus the Fox	17.95
Campaign	23.95	Home Alone (1Mb, N+)	17.95	Paperboy 2	17.95	Toki (N+)	17.95
Capcom Collection	20.95	Hook (1Mb)	17.95	Parasol Stars	17.95	Top Banana	17.95
Captain Dynamo	6.96	Hoversprint	6.96	Pen Pal	36.95	Top League (Comp) (N+)	20.95
Captive	12.95	Humans	20.95	Perfect General (1Mb)	23.95	Total Recall	6.96
Cardiacc	14.95	Hunt for Red October	7.95	PGA Tour Golf - Courses Disk	11.95	Touchdown	11.95
Carl Lewis Challenge	17.95	IK+	6.96	PGA Tour Golf Plus	20.95	Toyota Celica	6.96
Carrier Command	7.95	Impossible	6.96	Pictionary	6.96	Treasure Island Dizzy (N+)	4.49
Cartoon Collection	17.95	Impossible Mission 2 (N+)	6.96	Pinball Dreams	17.95	Treasures of Sav. Frontier (1Mb)	21.95
Castle Master	6.96	Indiana Jones & Fate Atl (ACT)	17.95	Pinball Fantasies (1Mb)	19.95	Trivial Pursuit	6.96
Castles (1Mb)	20.95	Indiana Jones & Fate Atl (Adv) (1Mb)	25.99	Pit Fighter	6.96	Troddlers	17.95
Celtic Legends	20.95	Indiana Jones & Last Crusade (ACT)	6.96	Platinum (Comp)	17.95	Trolls	17.95
Centurion	8.95	Indiana Jones & Last Crusade (ADV)	12.95	Police Quest 3 (1Mb)	23.95	Turrican	6.96
Champions (Comp)	13.95	Indy Heat	17.95	Pools of Darkness (1Mb)	21.95	Turrican II	6.96
Championship Manager (1Mb)	17.95	International Rugby Challenge	17.95	Populous II (1 Meg)	20.95	TV Sports Baseball	12.95
Chaos Engine (1Mb)	17.95	International Sports Challenge	20.95	Populous II - Data Disk	12.95	TV Sports Boxing	12.95
Chase HQ 1	6.96	Iron Lord (N+)	7.95	Populous II Plus (1 Meg)	23.95	U. M. S. II	20.95
Chess Champion 2175	13.95	Ishar - Legend of the Fortress (N600)	20.95	Postman Pat 3	6.96	Ugh!	17.95
Chessmaster 2100	12.95	Italian Tutor	15.99	Power-Up (Comp)	20.95	Ultima 6 (1Mb)	20.95
Chuck Yeager 2	8.95	Italy 1990	6.96	Powermonger	20.95	Untouchables	6.96
Cisco Heat	15.96	Ivanhoe	6.96	Powermonger Data Disk (WWI)	11.95	Utopia - New Worlds Data Disk	11.95
Civilisation (1Mb)	23.95	Jack Nicklaus Golf	6.96	Predator 1	6.96	Venus the Flytrap	6.96
CJ in Space	6.96	Jack Nicklaus Unlimited Golf (Accolade) (1Mb)	20.95	Premier Manager	17.95	Video Kid	17.95
Combat Air Patrol	20.95	Jaguar XJ220 (1Mb)	17.95	Premiere (1Mb)	20.95	Vikings (1Mb)	17.95
Combat Classics	20.95	James Pond	6.96	Primary Maths Course (3-12)	18.95	Virtual Worlds (Comp)	20.95
Conflict Korea (1Mb)	23.95	Jim Power	17.95	Prince of Persia	6.96	Viz	7.95
Conquests of the Longbow (1Mb)	23.95	Jimmy White's Whirlwind Snooker	20.95	Pro Tennis Tour 1 (N+)	6.96	Vroom	17.95
Cool Croc Twins	17.95	Joe & Mac - Caveman Ninja (1Mb)	17.95	Push-Over (1Mb)	17.95	Waxworks (1Mb)	23.95
Cool World	17.95	John Madden's Football	17.95	Putty (1Mb)	17.95	Wayne Gretzky 2	17.95
Count & Add (Under 7s)	8.95	Junior Typist (5 - 10)	14.95	Puzznic	6.96	Ween - The Prophecy	20.95
Crazy Cars 3	17.95	Keys of Maranon	17.95	Quest For Glory 1 (1Mb)	26.95	Wing Commander I (1Mb)	23.95
Creatures	17.95	Kick Off (1Mb)	20.95	R-Type I	6.96	Wizard	17.95
Cruise for A Corpse	19.95	Kick Off II (1/2 Meg)	13.95	R.B.I. Baseball 2	20.95	Wonderland (1Mb)	20.95
Crystal Kingdom Dizzy	13.95	Kick Off II (Final Whistle) (N+)	6.96	Ragnarok	26.95	World Class Leaderboard	7.95
Curse of Enchantia (1Mb)	23.95	Kick Off II (Giants of Europe) (N+)	6.96	Railroad Tycoon (1Mb)	23.95	World Class Rugby (N600)	17.95
D-Generation (1Mb)	12.95	Kick Off II (Return to Europe) (N+)	6.96	Rainbow Collection	13.95	World Class Rugby - 5 Nations	20.95
Dalek Attack	12.95	Kid Gloves II	17.95	Rainbow Islands	6.96	World Cup Soccer	7.95
Daley Thompson's Olympic Challenge	6.96	Kind Words 3 (1Mb)	36.95	Rambo III	6.96	WWF European Rampage	17.95
Dark Queen of Krynn (1Mb)	21.95	Knights of the Sky (1Mb)	23.95	Rampart	17.95	X-Out	6.96
Dark Seed	23.95	Kwik Snax	6.96	Raving Mad	17.95	Z-Out	6.96
Das Boot	12.95	Last Ninja III	7.95	Realms	20.95	Zak McKracken	10.95
Death Knights of Krynn (1Mb)	20.95	Leander	17.95	Reasoning with Trolls	10.95	Zool (1Mb)	17.95
Deliverance	17.95	Leeds United Champions	17.95	Red Baron	23.95	Zool - Enhanced (Amiga 1200)	17.95
Deluxe Paint IV	59.95	Legend	20.95	Red Heat	6.96	Zyconix	17.95
Discovery in the Steps of Columbus	20.95			Renegade	6.96		
Dizzy Collection	17.95			Rick Dangerous I	6.96		
Dizzy Panic	6.96			Rise of the Dragon	26.95		
Dizzy's Excellent Adventures	17.95			Risky Woods	17.95		
Donald's Alphabet Chase	17.95			Road Rash	17.95		

3 1/2" Double Sided Double Density

QUANTITY	PRICE
10	£5.30
20	£10.35
25	£12.65
30	£14.75
35	£16.90
40	£18.95
45	£21.10
50	£22.95
80	£36.35
100	£41.70
120	£49.40
150	£60.95
200	£78.75
250	£97.30
300	£116.30
400	£154.50
500	£184.65
1000	£364.30
2000	£728.50

WITH LABELS & WARRANTY

BOXES

(with keys and dividers)

10 Slimpack	0.94
40 capacity	£4.95
50 capacity	£5.60
80 capacity	£6.30
80 capacity stackable Banx	£14.95
120 capacity	£8.75
150 capacity	£10.95
150 Deluxe stackable	£21.95

JOYSTICKS

Python 1 (QS130F)	£9.25
Maverick 1 (QS128F)	£13.75
125+	£9.00
The Bug	£13.50
Star Probe	£13.50
Competition Pro 5000 - black	£13.75
Speeding A/F	£11.00
Navigator A/F	£13.75
Total Recall	£21.50
Topstar (SV127)	£19.00
Supercharger (SV123)	£12.50
Sting-Ray A/F	£22.00
Megastar A/F (SV133)	£22.00

MISCELLANEOUS

Deluxe Work Centre	£46.95
Cumana Disk Drive	£57.95
0-5Mb Upgrade + clock	£29.95
0-5Mb Upgrade	£26.95
1Mb Upgrade (500+)	£56.95
Mouse	

RICOH

PCL5 LASER PRINTER

NOW AVAILABLE WITH

FOR ONLY

LP1200 LASER 400 dpi 6 PPM 4Mb RAM £799

HP LASERJET III™ COMPATIBLE • FLASH ROM UPGRADEABLE!

+VAT Previous price for 4mb version £848-VAT

At a time when some manufacturers are considering price rises, as the pound struggles against foreign currencies, Silica Systems have some good news! We are pleased to present the award winning Ricoh LP1200 upgraded to 4mb RAM for only £799-VAT (£49 off the previous price of £848-VAT). And, if you don't require the extra benefits offered by the increased memory capacity, you may still purchase the 2mb RAM version at the normal unchanged Silica price of only £699-VAT.

Ricoh, the world's second largest manufacturer of laser printer engines, have used their expertise to produce a "first" in laser printers for the world market, the LP1200 with FLASH ROM. HP LaserJet III™ compatible, the LP1200 employs industry proven laser technology. Unlike LED printers, which use light emitting diodes, the LP1200's laser light source is able to produce the most accurate and intense printed images. It has a fast efficient processor and engine, together with a straight paper path design which allows printing at a full 6 pages per minute and, it can address a range of print resolutions up to 400 dpi. The 2mb RAM version can print a full A4 page of graphics at 300 dpi and a full A4 page of text, or A5 page of graphics, using standard resident internal fonts and the alternate controller firmware supplied, at 400 dpi. A free Windows driver supplied enables the 2mb Ricoh LP1200 to print a typical page of text at 400 dpi from Windows 3, using the alternate controller firmware supplied on the Windows Driver Disk and standard internal resident fonts. The 4mb RAM version has the added advantage of being able to print a full A4 page of graphics at 400 dpi and makes full use of the LP1200's 400 dpi printing capabilities, such as using Microsoft Windows fonts.

Unique additional standard features include FLASH ROM "future proof" technology and LAYOUT - a powerful document description language. The LP1200's unique internal FLASH ROM, which holds the printer controller firmware, can easily be updated as new developments in technology occur. This protects the investment you make in buying a Ricoh LP1200. Other manufacturers would require you to buy a new printer! Internal FLASH ROM and industry standard FLASH ROM IC cards can also be used to permanently store fonts, macros, graphics and extra emulations. Again, unlike the competition, the LP1200 includes LAYOUT a powerful document description language as standard, which offers unique opportunities to develop custom made printing systems. Forms and document templates can be designed and stored electronically in the LP1200's FLASH ROM, alleviating the need for pre-printed forms!

The LP1200 comes complete with a 100 sheet A4 paper tray and the facility to feed single sheets of paper and card up to 157gsm. An optional extra universal feeder provides the facility to automatically feed up to 150 sheets, from sizes of 98mm x 148mm to 216mm x 356mm in size, at weights of up to 158gsm. It can also feed up to 15 envelopes, overhead transparencies and labels automatically.



CORPORATE SALES TEAM
Tel: 081-308 0888 Fax: 081-308 0608

THE LP1200 IS A GENUINE LASER PRINTER AND NOT AN LED PRINTER. MAKE SURE YOU CHECK THE COMPETITION!

See how the Ricoh LP1200 compares to its Laser Printer Competitors

FEATURES	EPSON EPL4100	HP LJ/ET IIIP	M'MAN TALLY MT904+	IBM 4029 Model 010	RICOH LP1200
Average Street Price (excl. VAT) (*expected)	£569	£699	£699*	£750	£699
Official RRP (excl. VAT)	£945	£1,179	£1,099	£1,099	£1,195
Maximum resolution in dots per inch	300 x 300	300 x 300	300 x 300	300 x 300	400 x 400
Windows 3 Driver @ 400 dpi	-	-	-	-	YES
Print Speed	6ppm	4ppm	4ppm	5ppm	6ppm
Straight Paper Path	YES	-	-	-	YES
PCL 5 Printer Command Language	-	YES	YES	-	YES
HP-GL/2 Vector Graphics included	-	YES	YES	YES	YES
Resolution Improvement/Enhancement	YES	YES	YES	YES	YES
Standard RAM	0.5Mb	1Mb	1Mb	1Mb	2Mb
Full A4/300 dpi graphics with standard RAM	-	-	-	-	YES
Warm Up Time	<45 secs	<60 secs	60 secs	33 secs	45 secs
First Page of Text Output	<20 secs	<40 secs	34 secs	20 secs	<15 secs
Document Description Language included	-	-	-	-	YES
Flash ROM	-	-	-	-	YES
Upgradable Firmware	-	-	-	-	YES
IC Card Slot	YES	-	-	YES	YES
Scalable Resident Fonts - in HP LJ III Emulation	-	8	8	0	8
Resident Bit-Mapped Fonts	11	14	14	16	14
AGFA Intellifont Scalable Font Technology	-	YES	-	-	YES
HP LaserJet III Emulation Included	-	YES	YES	-	YES
EPSON FX Emulation Included	YES	-	YES	-	YES
IBM ProPrinter Emulation Included	-	-	YES	-	YES
Standard Tray Capacity	100	70	100	200	100
Protective cover on standard tray	YES	-	YES	YES	YES
Cost per copy**	1.65p	2.00p	1.71p	1.64p	1.65p
Min-Max Paper Weight in gsm	60-157	60-105	60-120	60-131	60-157
Able to print on OHP Film	YES	YES	YES	YES	YES
Able to print on card (157gsm - Manual Feed)	YES	-	-	-	YES
Standby -Noise Level	<40dB	31.7dB	<35dB	38 dB	<38dB
Printing -Noise Level	<50dB	43.3dB	<46dB	50 dB	<48dB

**As quoted by manufacturers - 2/4/92

All Trademarks are acknowledged

IT'S A WINNER!

Shortly after its launch, the LP1200 had scooped accolades from most of the major press reviewers... "The winner is the Ricoh... its graphics performance is staggering" Shopper Labs Best Buy COMPUTER SHOPPER AUGUST '92

"We liked the Ricoh's speed, extra memory (useful for graphic printing) and full HP LaserJet III emulation with scalable fonts... turning costs, ease of use and documentation are all also good, so this is a well rounded package" PC PLUS VALUE VERDICT PC PLUS AUGUST '92

"Compact, quiet and hassle free... excellent value..." PC DIRECT OCTOBER '92

"The Ricoh stormed ahead of the other printers in mixed page tests... was consistently the fastest non-PostScript machine in all the tests... it produced the most impressive pages, with prints consistently clear and well contrasted... produced some very fine prints at 400dpi" WINDOWS MAGAZINE JULY '92

PC TODAY BEST BUY OCTOBER '92

PC MAGAZINE UK CHOICE OCTOBER '92

PC PLUS GOLD

LASER PRINTER AWARDS

What to Buy for business

A "BEST BUY" DECEMBER 1992

Consumables + Accessories

CODE	PRODUCT	PRICE Excl. VAT
CAB 7500	Cable for PC/ST/Amiga	£8.47
KIT 5200	Laser Starter Kit inc Cable	£12.50
LAA 5238	Universal Feeder (2nd Tray)	£100.00
LAA 5262	2Mb RAM Module	£149.00
LAA 5210	Developer/Toner Cartridge	£65.00
LAA 5225	OPC Cartridge (Drum)	£89.00
LAA 5312	A4 Paper Tray (100 Sheets)	£35.00

CALL FOR A FULL PRICE LIST
*Note: A4 paper tray is already included in the printer price. More A4 trays can be purchased to feed different coloured stationery.

- **6 PAGES PER MINUTE**
Using a straight paper path
- **PCL5 - INC HP-GL/2**
With scalable fonts and vector graphics
- **SHARP EDGED PRINTING**
RicoH FIAL (Fine Image ALgorithm) enhances resolution
- **400dpi RESOLUTION**
(Default res. - 300dpi. Will address 200, 240 & 400dpi.)
- **2Mb & 4Mb RAM VERSIONS**
- **UNIQUE FLASH ROM**
For controller upgrade and storage
- **IC CARD SLOT** (PCMCIA/JEIDA Compatible)
For programmable FLASH ROM cards
- **EXPANSION BOARD SLOT**
For improved connectivity eg. Coax/Twinax, PC-LAN etc
- **LAYOUT Document Description Language**
- **SERIAL + PARALLEL PORTS**
- **1 YEAR ON-SITE WARRANTY**
Next working day response

LP1200 WITH SINGLE BIN & 2Mb RAM LAS 5200	£699	+VAT = £821.33
LP1200 WITH SINGLE BIN & 4Mb RAM LAS 5200 + LAA 5262	£799	+VAT = £938.83

SILICA SYSTEMS OFFER YOU

- **FREE OVERNIGHT DELIVERY:** On all hardware orders shipped in the UK mainland.
- **TECHNICAL SUPPORT HELPLINE:** Team of technical experts at your service.
- **PRICE MATCH:** We normally match competitors on a "Same product - Same price" basis.
- **ESTABLISHED 14 YEARS:** Proven track record in professional computer sales.
- **£12 MILLION TURNOVER (with 60 staff):** Solid, reliable and profitable.
- **BUSINESS + EDUCATION + GOVERNMENT:** Volume discounts available 081-308 0888.
- **SHOWROOMS:** Demonstration and training facilities at our London & Sidcup branches.
- **THE FULL STOCK RANGE:** All of your requirements from one supplier.
- **FREE CATALOGUES:** Will be mailed to you with offers + software and peripheral details.
- **PAYMENT:** Major credit cards, cash, cheque or monthly terms.

Before you decide when to buy your new laser printer, we suggest you think very carefully about WHERE you buy it. Consider what it will be like a few months after you have made your purchase, when you may require additional peripherals or consumables, or help and advice with your new purchase. And, will the company you buy from contact you with details of new products? At Silica Systems, we ensure that you will have nothing to worry about. We have been established for almost 14 years and, with our unrivalled experience and expertise, we can now claim to meet our customers' requirements with an understanding which is second to none. But don't just take our word for it. Complete and return the coupon now for our latest FREE literature and begin to experience the "Silica Systems Service".

MAIL ORDER HOTLINE **081-309 1111**

SILICA SYSTEMS

MAIL ORDER: Order Lines Open: Mon-Sat 9.00am-6.00pm No Late Night Opening	1-4 The Mews, Hatherley Rd, Sidcup, Kent, DA14 4DX	Tel: 081-309 1111 Fax No: 081-308 0608
LONDON SHOP: Opening Hours: Mon-Sat 9.30am-6.00pm No Late Night Opening	52 Tottenham Court Road, London, W1P 0BA	Tel: 071-580 4000 Fax No: 071-323 4737
LONDON SHOP: Opening Hours: Mon-Fri 9.30am-7.00pm (Sat close 6.30pm) Late Night: Thursday - 8pm	Selfridges (1st Floor), Oxford Street, London, W1A 1AB	Tel: 071-629 1234 Extension: 3914
SIDCUP SHOP: Opening Hours: Mon-Sat 9.00am-5.30pm Late Night: Friday - 7pm	1-4 The Mews, Hatherley Rd, Sidcup, Kent, DA14 4DX	Tel: 081-302 8811 Fax No: 081-309 0017
ESSEX SHOP: Opening Hours: Mon-Fri 9.30am-5.30pm (Sat 9.00am-6.00pm) No Late Night Opening	Keddies (2nd Floor), High Street, Southend-on-Sea, Essex, SS1 1LA	Tel: 0702 468039 Fax No: 0702 462363

To: Silica Systems, AMFOR-0393-75, 1-4 The Mews, Hatherley Rd, Sidcup, Kent, DA14 4DX

PLEASE SEND INFORMATION ON THE RICOH LP1200

Mr/Mrs/Miss/Ms: Initials: Surname:

Company Name (if applicable):

Address:

Postcode:

Tel (Home): Tel (Work):

Which computer(s), if any, do you own?

75M

E&OE - Advertised prices and specifications may change - Please return the coupon for the latest information.



Buying software is like buying clothes. Both items are soft, come in differently shaped boxes, and, er, both often cost varying amounts. Um, oh great – here comes **James Leach**...

Cheap 'n' Cheerful

AMIGA FORMAT

108

MARCH 1993

Adrenalynn

Global ■ £7.99

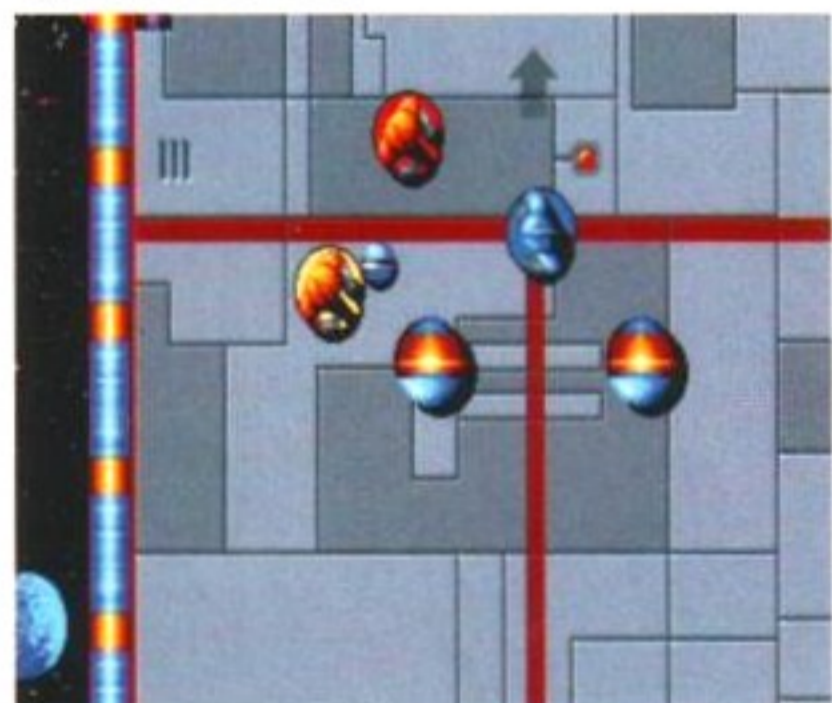

How's your ballbearing up? (This joke copy-right J Leach and E Morecombe.)

In the dim, and one would hope distant, future, it seems that all sport will be played by giant metal spheres, all rolling around inside the world's biggest cake tin. Fine. At least fat and lazy folk like us won't have to participate in it any longer.

There are two teams in this game, and each one has a load of ball-bearings, oh, and there is also a pair of goals. Well, that's the rules sorted out. From here on in it's just a massive, clanging, disorderly free-for-all.

You, of course, have control over one of these teams (if you've managed to cajole a friend into joining you, he can control the other team). You move the balls around using the joystick, and the idea is to use the magnetic fields which all the things on the playing area seem to possess. These fields enable the ball to stick to the players, but they also cause a bit of repelling now and again, for some reason best sorted by playing the game a lot.

There are about 16 power-ups which also affect the plays. Overall, each bout is like a cross between pool, pinball and *Speedball* (Bitmap Bros future-sport). It's limited fun, the graphics are OK and you'll either be brilliant at it or you'll give up.

Verdict **63%**

The Power

Global/Demonware ■ £7.99

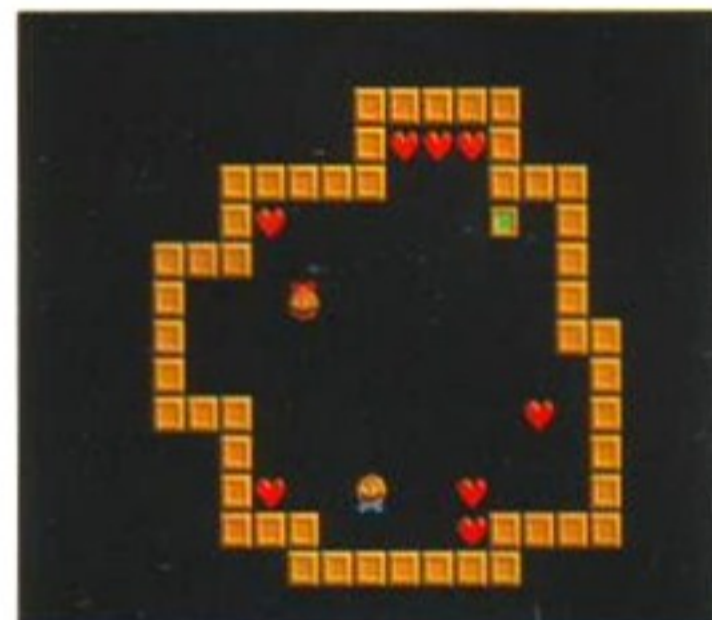

That's Jennifer Hart. She's *gworgeous*... Yes, true love, with little hearts... ahh.

Two little balls are in love, and must be together for all time. Unfortunately, the more masculine of these two spheres (although how on Earth you can tell is anyone's guess) must pop a load of hearts before he can be with his loved one.

If this sounds all rather familiar, then either you've got the game already, or you should seek immediate psychiatric attention, because it's one of the flimsiest ideas to try and base a puzzle game on yet. But then, when has a plot been particularly important to a puzzler's gameplay.

Puzzle game. Yes, that's given it away. But in this one, you can only move around the zones you find yourself in, by travelling in straight lines from one edge to the other. So by using logic, determination, speed and the little blocks you can also push around, it's possible to collect all the awkwardly placed hearts and wend your way back to the other blob in the middle somewhere; namely your loved one.

The Power is a weird puzzle game. It has a PD feel about it, but doesn't look shabby at all. It might just be that the idea upon which it is based, namely that of moving in straight lines until stopped by something, isn't strong enough. Still, it's about love, so it must be all right in a misty-eyed sort of way.

Verdict **74%**

PP Hammer and his Pneumatic Weapon

Global ■ £7.99



But why does PP Hammer have to be outside my flat at 7am every Sunday?

This caused not a few sniggers when its amusing title first appeared on the shelves I can tell you. And rightly so, because pneumatic weapon does sound rather a lot like engorged pen... (Stop it right now – Ed.)

Anyway, the nub of the crux is that *PP Hammer* is a platform with such a minor difference that it's almost no different at all.

The guy you control must use his pneumatic drill to tunnel through some of the floors he passes in order to collect lives, reach hitherto inaccessible zones, and generally progress in a satisfactory manner through the game.

The whole thing is pretty reminiscent of *Rick Dangerous*. It's got nice graphics, plenty of platforms to leap up and down on, and a horde of points for you to try and amass. There are the obligatory traps and puzzles to overcome, and you won't be at all surprised to find out that you can do each level in several different ways, simply by choosing alternative paths.

Overall, *PP Hammer* is a competent game. It's not as good as the best of the genre, nor is it the way by any means. It just simply is, and if you're a fan of the name, you might want it anyway.

Verdict **72%**

Pipemania

Touchdown ■ £9.99

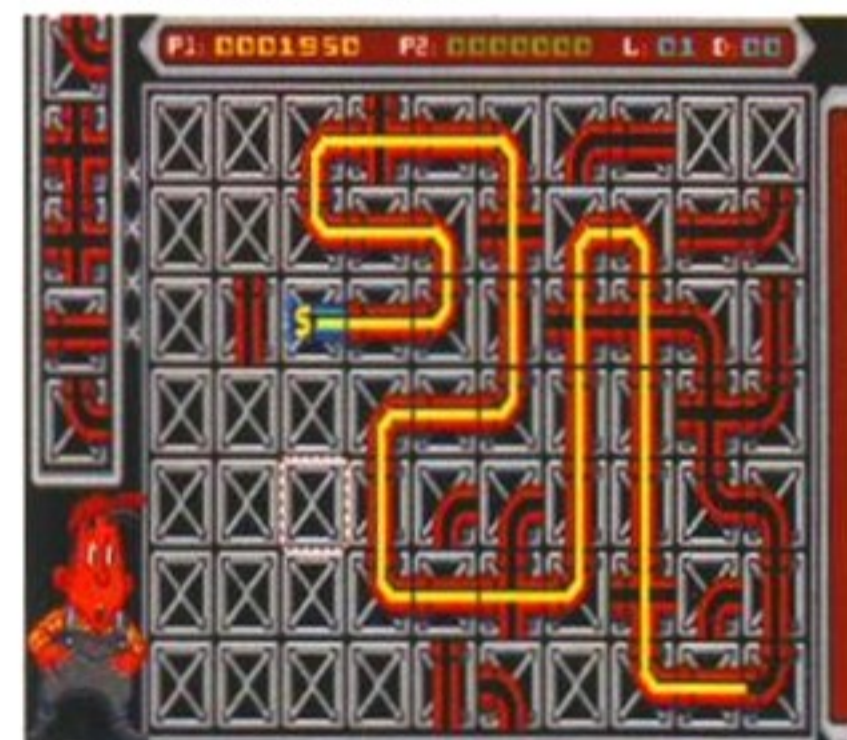

And what do you think the crew of the tanker Brear were playing that fateful night?

It's kind of a Kafka-esque nightmare, this game. You must lay down a succession of pipes in a connected order around a grid as quickly as possible, while some sort of goo of indeterminate consistency flows through them, trying (and inevitably succeeding) to catch up with you.

It's a very neat game, and one which could almost replace the different shaped objects as an educational toy. But there's one small problem. It's impossible to win. You know that

all you can do is survive for longer than you did last time.

The screen is a finite size and the goo never stops flowing, so you physically can't beat it. This might be a major flaw with *Pipemania*, depending on how you look at it.

Other than that, the game is, like most of the ones reviewed here, pretty good puzzly fun for a while. It's both nicely programmed and executed, but ultimately it's something you put away after a while because your brain and fingers hurt (and possibly also your oesophagus, if you've been getting into the vocal swing of things too much, I certainly did).

Verdict **83%**

Gem'X

Global/Demonware ■ £7.99
Tetris really does have a lot to answer for. This game for example, Gem'X, is much like those Krypton Factor tests they have. You must manipulate a load of coloured, er, things, on the left of the screen until they look exactly like those on the right.

This is achieved by either clicking on the gems (as they're probably called) so that they change colour in rotation. You must do this a lot, until you get something approximating the colours you see on the right. Alternatively, just prop a book against the right-hand side of the screen and ignore the gameplay aspect. You'll soon lose, but there won't be any of the

angst of knowing just how close you came.

It's like *Klax*, it's like *Tetris* (in a small, puzzly way) and it's a little like the other game with coloured balls (whose name escapes me). It's fun though, but might be a bit too infuriating to be a long-term prospect. Still, this is a gameplay thing (and seems to be personal to me), and nothing to do with the quality of the program, which is of the very highest.

If you're a real puzzle, brain-power fan, Gem'X is great, and well worth buying now it's on a budget label. Be prepared to spend a long time getting good.



84%

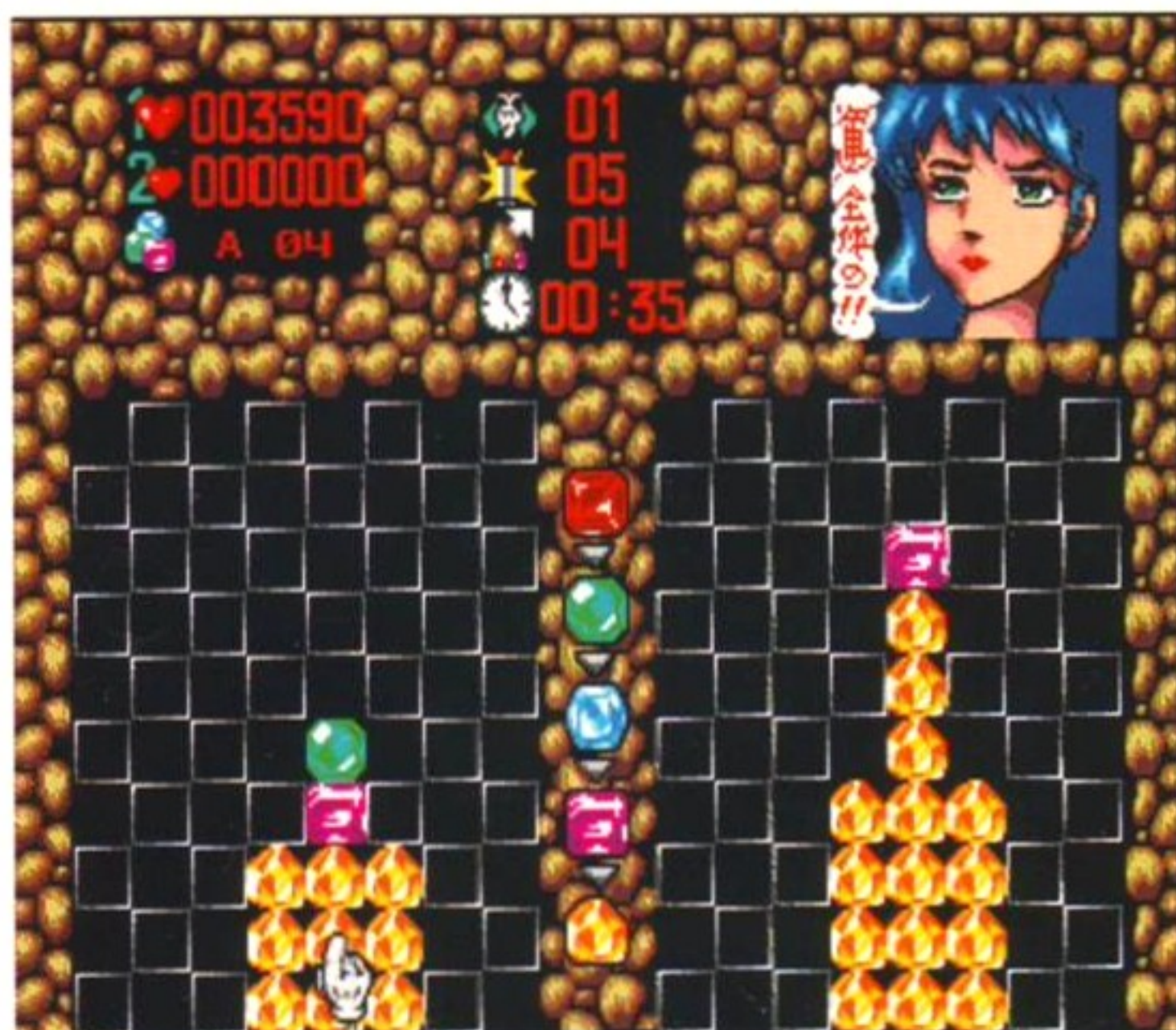

It's got blocks, it's got colours, it's got a cute Japanese girlie. What more could you want from a game? (Apart from beer, curry and carnal gratification, obviously.)



The translation reads: "Gem'X looks difficult, turns out to be easier than you thought, then turns out to be difficult again. Oh, and then turns out to be really difficult later. But ultimately is quite easy, as long as you get past the difficult bit."

SOFTWARE YOU'LL WANT TO GET YOUR KIDS INTO NOT OUT OF

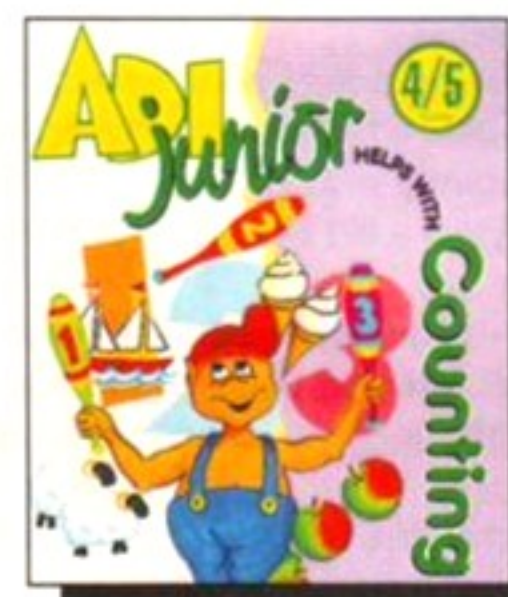

THE ADI JUNIOR RANGE
For 4 to 7 year olds.

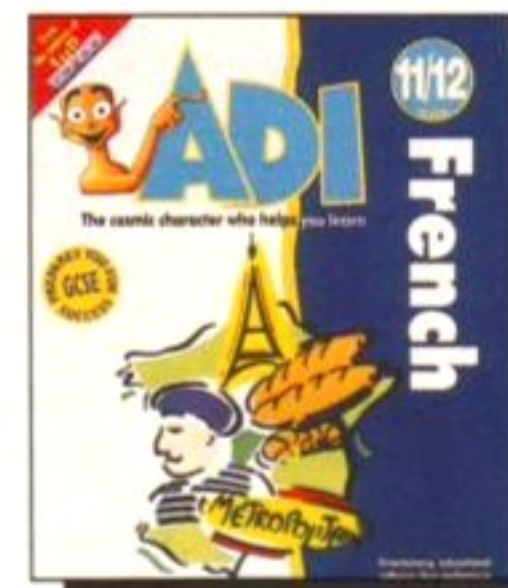

THE ADI RANGE
For 11 to 15 year olds.



FUN SCHOOL 4
For 3 to 11 year olds.



FUN SCHOOL SPECIALS
For 5 to 13 year olds.

Ever wished your children were getting top marks instead of top scores from their computer games?

With our range of educational software, that wish becomes reality.

We've swapped Shoot-'em-Ups for Add-'em-Ups and science fantasy for science fact with our brilliant packs that'll have them glued to their homework.

Our Fun School packs cover many favourite topics, while the Fun School Specials teach children all about subjects like Maths and Spelling.

For older students, our ADI range is every bit as much fun but has a more academic bent, helping kids sail through their GCSEs.

And for tiny tots with big brains, look out for the ADI Junior range.

Europress Software. Just don't let them know you approve.

EUROPRESS
SOFTWARE

CREATIVE. EDUCATION

Bubble Dizzy

CodeMasters ■ £7.99



Chuck him in some boiling water for four mins, then smash his head open.

Dizzy the infamous Egg has been pitched into the ocean by, presumably, someone who fervently believes that the world might have seen the last of him. Don't worry though, luckily he has with him his trusty snorkel.

So, thankfully Dizzy doesn't drown (well, not immediately in any case). Instead, he decides to make his way back up to the surface once more. (Handy hint: a good way to find out if an egg is rotten is to drop it in water, if it floats then it's a real rotter.)

This is where our Easterphobic friend needs your help. You must control Dizzy, bouncing him off the bubbles which rise up from the depths of the sea-bed. These bubbles are effectively moving platforms, and Dizzy must try to leap between them, cadging a lift ever upwards until they finally burst.

Interesting technical point here - how does a bubble burst when it's underwater, exactly? But never mind. You get Dizzy to the top as fast as you possibly can, trying to avoid all the nasties, like whales, jellyfish and other crustaceans.

It's another simple, infuriating concept, and you'll be swearing in fluent Russian at the screen before long. Never mind, there's every chance that your two-year-old nephew will pick it up and complete the game at the first sitting...

It's cute, cheerful, not amazing, and basically a bit of mildly addictive fun.

Verdict 78%

First Class

GBH ■ £7.99



This picture says it all, really. Talking footwear requires no further response.

This one, from the rather violent-sounding GBH, is not in fact a puzzle game, but an educational piece of interactive software which enables your kid (or anyone else's, presumably) to learn simple words.

The hosts for this slice of what has horrifically been described as 'edutainment' are the Shoe People. They're a cheerful bunch who, staying true to their name, resemble items of quality footwear. Each, of course, has a name and a personality (much like your favourite clogs in real life) and the child has to guide them through a whole series of adventures. The wee 'uns can only progress, though, if simple spelling and recognition tests are completed successfully.

The whole thing is very bright, colourful and attractively presented. It's been child-proofed as much as possible, and it comes with a small, but comprehensive manual explaining what the interacting child should be getting out of each stage, and what he or she will be learning.

Without extensive testing on children, it's difficult to gauge the effectiveness of games software such as this, but it's certainly of the highest quality, and clearly takes the child through basic spelling and then on to slightly more advanced levels in word construction. Your kids will love it.

Verdict 88%

Mega Mix

Psygnosis ■ £29.99

Ork



Doesn't this look like the ultimate challenge? You're right, trick question.

This, we are forced to presume, is the American spelling of orc. You know, those disgusting creatures out of *The Lord of the Rings*. But the game itself pretty much has nothing to do with these, so we might well be presuming incorrectly.

Never mind. It's a very pretty game in which you platform yourself around the levels, blasting things with a weedy gun and trying to avoid getting caught by all manner of Giger-esque creatures. Come to think of it, you're pretty Giger-esque yourself, with nicely dappled colours and a vaguely metallic look.

The game, as you might have surmised from all this, is very nice to look at. Parallax scrolling and tons of tricky platforms make it seem like the ultimate challenge. But it doesn't play anything like it looks. It just doesn't feel right. The jumping isn't very controllable and the moving around is lethargic and, after a fashion, annoying.

What a pity this all is, because there's a lot to *Ork* and it all looks beautiful. If you get used to the weird playing characteristics, you might find it the game of your dreams, but to be honest, this is a long shot.

Leander



"Er, look. Couldn't we discuss this man-to-man, in a civilised manner?"

You play a sort of Roman centurion fellow, who has got to negotiate yet more platforms in order to er, kill things, recover lost things and generally set the world to rights. Does anyone really care about the plot in platform games? Does anyone actually imagine that if the software houses actually manage to think up a decent plot down the pub of an evening, it'll sell more copies? Perhaps.

But enough idle speculation.

Leander is better than *Ork*. It doesn't look as good, but the character is controllable, playable and has a lovely sword-swipe with which he dispatches baddies left, right and sometimes in the middle too.

There are tons of places to explore over the three large worlds, and during your titanic battle with evil, you must supplement your armour, energy and sword-swiping abilities. This is all par for the course.

Leander is fun. It's more fun than *Ork*, and it's something you can easily get into (at first). Be warned though, it does get tricky. If you're not a dab hand with the joystick, you might run into problems of the dying-a-lot kind.

Agony



And Olly the owl swooped down to pick up his favourite walnut clusters...

They're asking for trouble, naming a game *Agony*. But, much as the urge to make jokes about it is there, you won't find them in this review. This is primarily because there isn't enough space.

Agony is a scrolling shoot-em-up pretty similar to *Apidyra*, in which you, as an owl, must encounter all sorts of natural foe, and blast them to bits. What you're firing is a bit of an enigma, because owls don't come equipped with offensive weaponry as a rule (except, of course, the tawny owl, as everyone knows).

It's slow but taxing, and the graphics are gorgeous. The sedate pace means that instead of firing you up with adrenaline, you'll be lulled by its prettiness until you die. Not a good sign. *Agony* isn't racy enough to make it worth playing for very long. It's not easy, and it suffers from not being engrossing either.

Verdict 70%

Sports Masters

Empire ■ £29.99

PGA Tour



Get this tournament under your belt and you can retire to play golf all day.

Indy 500



Now I want you to stop as if a child has run out across the race-track.

Advantage Tennis



Playing tennis with Olive Oyl is definitely mind-expanding in a surreal way.

European Championship 1992



The players are on the pitch! They think it's just started! It has now!

This is definitely a golf game to which other golf games are sometimes compared. You can do all the right golffy things, including play on half-a-dozen courses, fiddle around with all the clubs and even slice and hook to avoid those awful bunkers (*Amiga Format* refuses to call them sand-traps).

It's fast, it's accurate, it's got great 3D effects and views, and it's as playable as the devil (which is quite a bit). *PGA Tour* is worth having in your collection, that's for sure.

This old *Format Gold* is a real classic. It's the predecessor to *Formula One Grand Prix* (both were written by Geoff Crammond) and it's got some beautiful 3D graphics, whizzing by at the speed of a racing car.

Crash replays, dangerous overtaking, stupidly lethal manoeuvres and the other things that you associate with *Indy 500* are all here, and there's a damn fine game here too. You should own this game as well as *PGA Tour*, so it's lovely to see them in the same box.

And what's the advantage, you ask. Well it isn't immediately apparent. Perhaps it's something to do with having the body of Olive Oyl. Anyway, *Advantage Tennis* is another fun game. You can do all the stuff you'd expect. Top-spin, volleys, backhands, forehands, butterfly and crawl.

The graphics work, even though you'll never be fooled into thinking those were real people, and once you've mastered the basics, you'll have a great deal of fun with it.

Oh dear. The dog. There had to be one, didn't there? Anyway, forget this game. If you've seen *Sensible Soccer*, you'll chuckle at the sideways-viewed non-playability of it all. It's slow, inept and the opponents are crap.

The only positive thing is you don't have to muck around choosing your team members and setting up playing positions before going on pitch. If you want to just play, you can. It's a pity that nobody will want to.



LOOK NO FURTHER!!

FOR THE CHEAPEST AND BEST !!
THE LATEST TOP 50 GAMES FOR YOUR AMIGA:

* 3D Construction Kit 2	£34.99
* A10 Tank Killer	£22.99
* Addams Family	£15.99
* Airbus A320	£24.99
* Aquatic Games	£15.99
* Assassin	£15.99
* Beast 3	£19.99
* Big Box 2 (10 games)	£19.99
* Bug Bomber	£15.99
* Catch'Em	£15.99
* Championship Manager	£15.99
* Civilisation	£22.99
* Crazy Cars 3	£15.99
* Curse of Enchantia	£22.99
* Dune	£19.99
* F1 Grand Prix	£22.99
* Fire & Ice	£15.99
* Golf (Microprose)	£22.99
* Hagar the Horrible	£15.99
* Harrier AV8B	£27.99
* Head to Head (Mig29 vs F19)	£22.99
* Humans	£19.99
* Jaguar XJ220	£15.99
* Jimmy Whites Snooker	£14.99
* John Madden's	£15.99
* Kick Off 3	£15.99
* Kings Quest 5	£25.99
* Leisure Suit Larry 5	£25.99
* Lemmings 2	£15.99
* Lotus 3	£15.99
* Lure of the Temptress	£19.99
* Megalomania/First Samurai	£19.99
* Monkey Island 2	£24.99
* Nigel Mansell GP	£15.99
* PGA Golf	£19.99
* Pinball Fantasies	£15.99
* Pool	£15.99
* Premiere	£19.99
* Railroad Tycoon	£22.99
* Red Baron	£22.99
* Sensible Soccer	£15.99
* Silly Putty	£15.99
* Space Crusade	£15.99
* Space Shuttle	£34.99
* Special Forces	£22.99
* Street Fighter 2	£17.99
* Striker	£15.99
* Sword of Honour	£15.99
* Wing Commander	£19.99
* Zool	£15.99

The above represents only a very small selection of titles that we stock. If you do not see what you want listed, please give us a call.

Given the nature of games publishers, we can not guarantee that all the above will be released by the time this advert appears. Please call us to check availability to avoid disappointment.

Post & Packaging £1.50 - Securicor £5

48 hour despatch (cheques 7 days)

Cheques should be made payable to SoftStore

Access and VISA cards accepted

SoftStore, Dept DAF, PO Box 1720, Slough,

SL3 0YX

0753-683336



THE CENTRE OF TEC

WTS ELECTRONICS LTD, CHAUL END LANE, LUTO



Amiga 600 Pack

- UK specification
- 1MB system RAM, mouse
- Full workbench disks, manuals & leads
- Free game included in pack
- Two Python joysticks
- 100 capacity lockable disk box **£295**

Amiga 600 HD Pack

- Plus internal 20MB hard drive **£395**
- Plus internal 60MB hard drive **£475**
- 1MB extra memory add **£29**

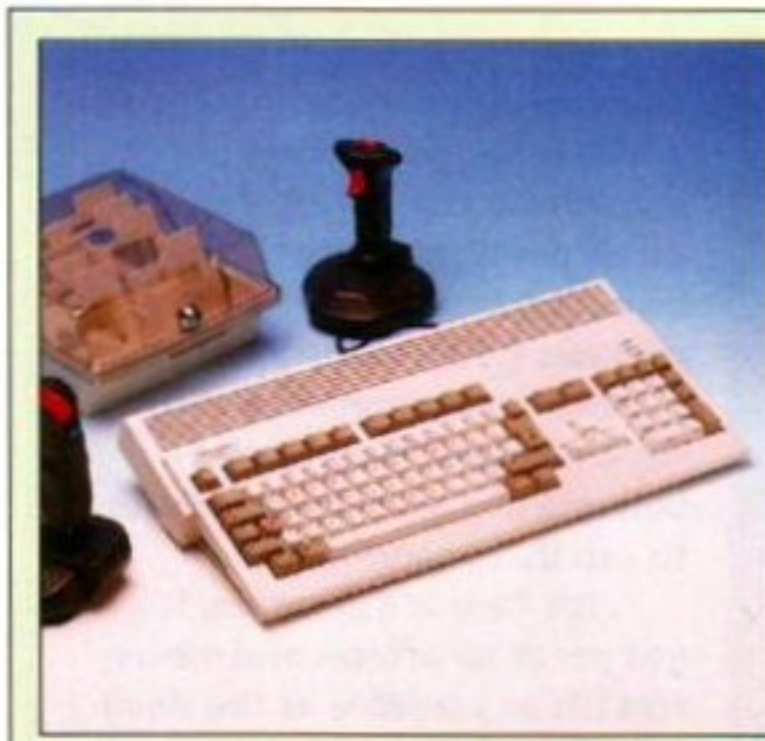

Amiga 1200 Pack

- 32-bit 68020 Full power
- Super Hi-Res graphics
- 2MB Chip memory
- PCMCIA Technology
- Alpha numerical keypad
- Two Python joysticks
- Free game
- 100 Capacity disk box

- A1200 Pack **£385**
- A1200 with 20MB hard drive **£485**
- A1200 with 60MB hard drive **£585**

Weird, Wild & Wicked A600



- Game players paradise
- Push Over game
- Formula 1 Grand Prix game
- Putty Game
- Extra free game
- Deluxe Paint III
- 2 Python joysticks
- 100 Capacity disk box

- A600 weird, wild & wicked pack **£329**
- A600 as above with 20MB HD **£429**
- A600 as above with 60MB HD **£509**

A1200/A600 Upgrades



- Easy to install upgrade kits
- Full instructions and cables where necessary
- All drives supplied with formatting instructions and software

- 20MB HD Upgrade Kit **£109**
- 60MB HD Upgrade Kit **£219**
- 120MB HD Upgrade Kit **£274**
- ProRam 1MB Memory A600 **£39**
- ProRam 2MB PCM-CIA A600/A1200 **£124**
- ProRam 4MB PCM-CIA A600/A1200 **£194**

Philips 8833 MKII Monitor



- 14" high resolution colour display
- High clarity stereo sound output
- Full RGB and composite inputs.
- Free 1.5 metre long RGB cable
- Full UK warranty
- 3 Free games

- Philips 8833 MKII Monitor **£219**
- When purchased with an Amiga 600/1200 **£209**

SVGA Monitor



- 14" Super high resolution colour display
- Professional IBM compatibility
- Complete with cable
- Full UK warranty
- 2 Free games

- A1200 SVGA Monitor **£228**
- When purchased with an Amiga 1200 **£218**

Workstations



- Ergonomically sound
- Facilitates up to three external floppy drives
- Made in the UK
- Strong and robust
- Aesthetically pleasing
- Keep your desk neat and tidy
- Supplied complete and assembled with free mouse mat

- A500 Workstation **£36**
- A600 Workstation **£36**
- A1200 Workstation **£36**

Peripherals



- 100 Capacity lockable disk box **£5.99**
- Squick mouse **£13.99**
- Mouse mat **£1.99**
- TDK high quality DSD (10) disks **£9.99**
- Computer Mall DSD (10) disks **£6.00**
- 1000 colour disk labels **£12**
- LC20 printer ribbon **£3.49**
- Jet Fighter joystick **£13.99**
- Apache joystick **£6.99**
- Python joystick **£9.99**
- Zipstick joystick **£14.99**

- Vast range of leads for many applications - **Please call**

Scanners



- Allows image processing in a useful and unique fashion
- Comes complete with operation manual
- One of the fastest growing applications for home and professional users
- High specification coupled with cost effective pricing

- **Power Hand Scanner**
- 64 greyscales 100-400 DPI
- Thru'port to printer
- Fully compatible with Delux Paint 4, etc.
- Advanced software
- Power Hand Scanner v2.0 **£93**
- Power Hand Scanner v3.0 **£105**

Music



- Highest quality stereo sound sampling
- Compatible with A500, A600, A1200, A1500/2000, A3000

- Screen Beat Speaker System **£25**
(Adds amplified stereo sound to the Amiga)
- GVP Digital Sound Studio **£49**
- Megamix Master **£37**
- Stereo Master **£34**

TECHNICAL EXCELLENCE

Est. since 1984



WTS ELECTRONIC LTD, BEDS, LU4 8EZ TEL (0582) 491949 (6 LINES)

Pro Agnus 2MB



- Provides a full 2MB of Chip Memory for the Amiga 500 and A1500/2000
- Designed and built in England
- Supplied with 8375 Obese Agnus
- Includes 2Mb Memory on board in the form of low power Zips
- Allows the processing of elaborate animation and sound sampling
- Provides the same max. chipmemory as the A3000/A600 &500+
- Increases addressable memory space from 9MB to 10MB
- Complete with full instructions and flying leads
- British made

- Pro Agnus 2MB **£139**
- Fitted **£159**

Memory Expansions

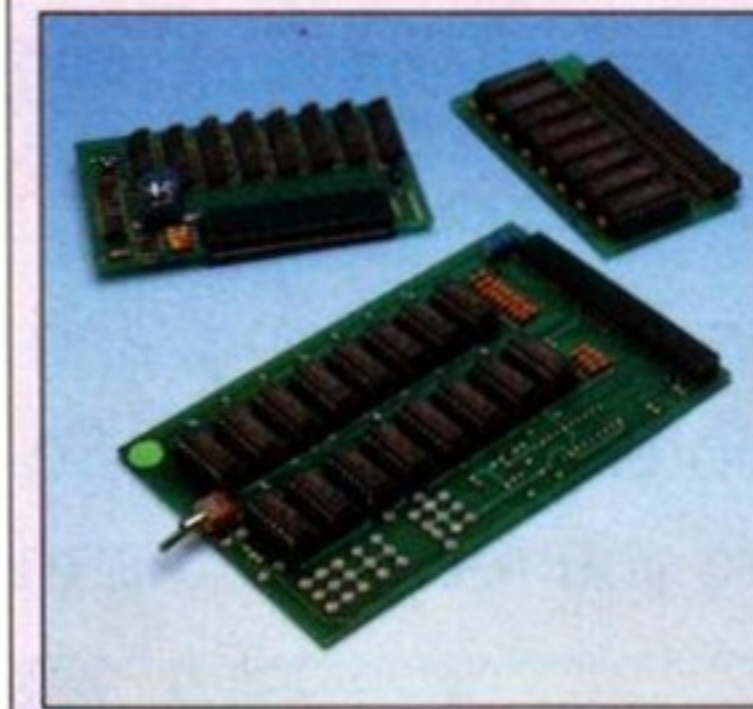

A500 Pro-RAM 0.5 Meg. Upgrade

- Chip memory compatible
- British made
- Without clock **£16**
- With clock **£19**

A500 Pro-RAM 1.5 Meg Upgrade

- Gives a full 2MB of memory **£74**

- A500+ 1MB Meg Upgrade **£29.95**

High Current Power Supply



- Allows the addition of peripherals without damage to computer or power supply
- Why risk damaging your expensive kit when one simple investment will ensure total peace of mind now and for the future
- Switch mode design
- Full crow bar projection
- A500, A500+ and A600 compatible
- British Made

- A500 Power supply unit **£44.95**
- A590 Power supply unit **£44.95**

Cumana 3.5" External Drive



- High Quality
- Renowned and proven reliability
- Top notch specification
- Anti-click
- Long moulded cable
- Slimline design
- High impact plastic

- Cumana external drive **£54**
- Cumana external drive + 100 capacity disk box **£57**
- Cumana external drive + 100 disk box + 20 blank disks **£63**
- A500/A500+ Internal replacement disk drive **£46**

Supra Modems

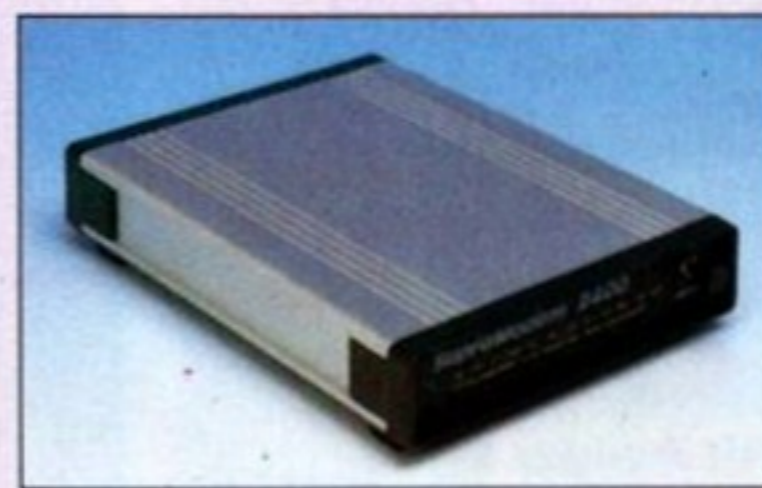

- Utilise hundreds of PD Bulletin Boards
- Communicate with fellow computer users
- Cuts down on telephone bills by using fast efficient baud rates
- 100% Hayes compatible
- Tone pulse, Auto Dial/Auto Answer
- Standard RS232 Interface
- Programmable number storage
- Free Coms software

- Supra 2400 **£84**
- Supra 2400+ **£129**
- Supra Fax Plus (0-9600 BPS) **£148**
- Supra v.3.2 (Fax Modem) **£199**
- Supra v.32 BIS (Fax Modem) **£358**

Chips and Spares



- WTS have sole distribution rights from Americas biggest Commodore chip distributor

- Workbench 2.04 Kit (Includes manuals, disks & chip) **£78**
- Kickstart 2.04 **£32**
- Kickstart 1.3 **£24**
- Kickstart ROM Swapper (Swap between kickstarts) **£18**
- Fatter Agnus 8372 **£44**
- Obese Agnus 8375 **£48**
- High Res Denise **£29**
- 1MB x 9 Simms **£32**
- 1MB x 4 Zips **£16**
- 8520 CIA **£8**



SALES HOTLINE 0582 491949 (6 LINES), 0480 471117 (24HR), FAX ON 0582 505900

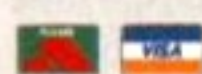

Credit Card ordering by phone is easy. Simply phone our sales hotline quoting your credit card number., expiry date, name and address and the products you wish to order and we'll do the rest. Alternatively write the above details on your letter when ordering by post.

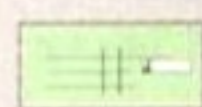

When ordering by post in cheque form please write your cheque card guarantee number on the reverse of the cheque and send along with your order. Postal Orders are also accepted.



NO DELIVERY CHARGES TO UK MAINLAND. MINIMUM ORDER AMOUNT £15.00.

Should you wish your order to be sent by Group 4 Security service please add £5. This method is normally faster than the postal service and includes Comprehensive insurance.



WARRANTY: One year return to base (excluding chips).

ONE YEAR EXTENDED WARRANTY: Available on all products (excluding chips) at 10% of purchase price when ordering.

WHERE TO FIND US!

Head Office
WTS Electronic Ltd
Chaul End Lane
Luton
0582 491949

Computer Mall Bedford
No.16 Downstairs
The Harpur Centre
Bedford
0234 218228

Computer Mall St. Neots
No.6
Priory Mall Shopping Centre
St. Neots
0480 471117

Computer Mall Hertford
49 Railway St.
Hertford
0992 503606

Computer Mall Dunstable
84 High Street North
Dunstable
Bedfordshire
0582 475747

All prices quoted or products stocked are subject to stocking levels and availability. WTS cannot be held liable or supply reimbursement for force majeure, or items, which are out of stock due to demand or low stock at its suppliers which may result in delayed or non delivery. WTS reserve the right to amend prices or revise packs or specifications without prior notice at any time without liability upon itself.

Getting the most from your AMOS Coverdisk

Last month's tutorial was AF Solo Pong, and although it's a deeply wonderful game it doesn't really explore the full potential of AMOS. So, this month we'll show you how much more you can do with AMOS. Are you ready for the truly remarkable Son Of Pong: The Sequel?

AMIGA FORMAT

114

MARCH 1993

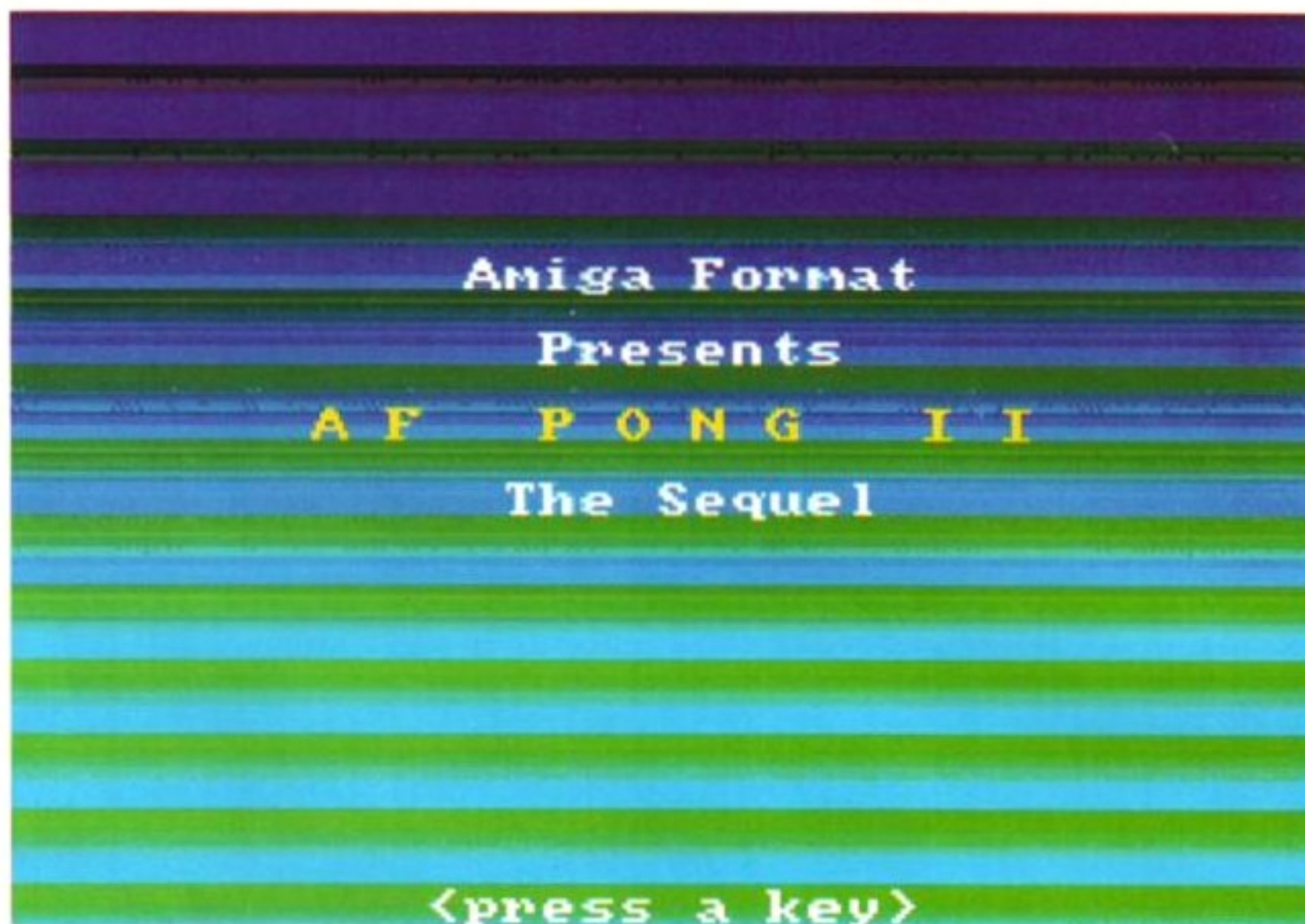

It's really quite simple to make a plain screen look better - use the Rainbow command for some copper effects. The copper (CO-ProcessER) can change any colour value, anywhere on the screen - and it does so while the real processor is running programs. So using copper effects does not usually make any difference to the speed of a program. Check out how many of your programs use copper effects - it's a visual trick unique to the Amiga.

THE PONG GAME we covered last month was elementary, but it gave you a grasp of how a game fits together in AMOS. This time around we'll be adding some bells and whistles to the basic *Solo Pong* to give you a much more attractive and playable result. For the moment we're sticking with programs which generate their own graphics, and although this is not usually the way it's done, this makes it nice and simple to do something which you can just type in.

All the sprites are still created on screen and grabbed before the game begins, and there are no sound samples or anything like that. The sound effects are supplied by the built-in sounds with which AMOS comes equipped, namely BOOM and SHOOT. We will go on to programs with external graphics and sounds that are created by *DPaint* and sound samplers, but for now, to keep it nice and easy, we'll stick with simple graphics creation.

Pong is an old game, and one which every human being on the planet must have played at some time. But writing your own *Pong* game has always been a major feat on almost any computer and any BASIC you care to mention. AMOS makes it very simple, with special keywords which take out all the hard work and leave you to concentrate on how to put the program together.

AF`Pong2`.AMOS was created using last month's AF`SoloPong`.AMOS as a basis, and adding things which would make the game better looking, and much more interesting to play. The basic routines for sprites

and their movement are exactly the same. The vectors are still sitting there vectoring away, sending the ball bouncing around in various random directions which are roughly related to the one it was going in anyway. But whereas *Solo Pong* had but one control method, and one player, this new version has two players on joysticks, a rainbow-coloured backdrop for the title and main game screens, scoring, and about a dozen other little refinements and tweakings.

Let's take the program step-by-step.

Thinking ahead in a program is all very well, but by and large most of the things you add to a program after the basic construction are afterthoughts. There are various types of variables in AMOS, which represent figures and numbers in the program. The reason you use variables is because in computer programs you sometimes don't know exactly what value something will be, and it's up to the calculations and structure of the program to figure out these values. For example, this little program:

```
For X=0 To 100
  Print X
Next X
```

The variable is X, and this represents the numbers 0 to 100. Run the program and you get a stream of numbers from 0 to 100 down the side of the screen. This is why people use computers to run repetitive tasks, as it's

easier to type this program than it is to type the numbers 0 to 100. The variable types are as follows. Numbers are represented by numeric variables. These can be anything like X, X2, EXXONVALDEZ, etc. Any combination of letters you like.

Words are represented by alpha-numeric variables. These are the same as numeric variables but they have a \$ symbol on the end, so they look like this: Z\$, ZDR\$, LOONYS\$, etc. Those are your basic types, but there are other styles called floating-point number variables. These are variables which can accept a floating-point number like 1.34, 3.5 or 23.3456423. To denote these you append them with a # symbol, like so: NUMBER#, PROBBY#, X1#, etc.

All variables are 'local' unless otherwise specified. This means that a variable will be unique to the part of the program it was defined in. A variable defined in the main program isn't available inside a procedure, and a variable defined in a procedure isn't available outside, UNLESS you make the variable 'Shared' or 'Global', which is what we've done to the variables at the start of this new program:

```
Global SCORE1, SCORE2, WON
```

The variables SCORE1 and SCORE2 are the score for players 1 and 2, defined in PROCs called LOSEP2 and LOSEP1. WON is also a variable declared in a procedure called WIN. Adding these variables was a bit of an afterthought, but it's always a good idea to stick any

That listing in full

```

***Amiga Format Pong II**
' **
Global SCORE1,SCORE2,WON
Screen Open 0,320,200,16,Lowres
Curs Off : Hide
Set Rainbow 0,0,202,"", "", ""
For C=0 To 201
  Rain(0,C)=C
Next C
Rainbow 0,0,49,202
Double Buffer
Paper 0 : Ink 4 : Bar 0,0 To 5,30
Ink 2 : Polyline 0,30 To 0,0 To 5,0
Get Sprite 1,0,0 To 6,31
Cls 0 : Ink 2 : Circle 5,5,2 : Paint
5,5 : Get Sprite 2,0,0 To 10,10
TITLE:
Bob Off 1 : Bob Off 2 : Bob Off 3
Cls 0 : Pen 2
Locate ,7 : Centre "Amiga Format"
Locate ,9 : Centre "Presents"
Pen 3 : Locate ,11 : Centre "A F P O
N G I I"
Pen 2 : Locate ,13 : Centre "The
Sequel"
Locate ,24 : Pen 2 : Centre "<press a
key>" : WON=0 : SCORE1=0 : SCORE2=0 :
Wave 0 To 15 : NOISE : Wait Key
RESTART:
If WON=1 Then Goto TITLE
Cls 0
Ink 11 : Bar 0,0 To 319,5 : Bar 0,194
To 319,199
Ink 2 : Bar 160,0 To 165,193
Pen 5 : Locate 0,0 : Centre " AF Pong
II "

```

```

Pen 2 : Locate 0,0 : Print "P1
";SCORE1 : Locate 34,0 : Print "P2
";SCORE2;" "
X=150 : Y=100
Y1=50 : Y2=50
DX=Rnd(4)+2 : DY=Rnd(2)+1
R1=Rnd(10) : If R1>5 Then DX=-DX
R2=Rnd(10) : If R2>5 Then DY=-DY
'
MAIN:
Add X,DX : Add Y,DY : If Y<=5 or
Y>=190 Then DY=-DY
Z1=Bob Col(1) : Z2=Bob Col(2) : If Bob
Col(4) Then DX=-DX
If X<=-20 Then LOSEP1 : Goto RESTART
If X>=320 Then LOSEP2 : Goto RESTART
If Z1<>0 Then DX=-DX : DX=Rnd(5)+3 :
Shoot
If Z2<>0 Then DX=Rnd(5)+3 : DX=-DX :
Shoot
If Joy(1) and 2 Then Y1=Y1+6 : If
Y1>165 Then Y1=165
If Joy(1) and 1 Then Y1=Y1-6 : If Y1<5
Then Y1=5
If Joy(0) and 2 Then Y2=Y2+6 : If
Y2>165 Then Y2=165
If Joy(0) and 1 Then Y2=Y2-6 : If Y2<5
Then Y2=5
Bob 1,5,Y1,1 : Bob 2,310,Y2,1 : Bob
3,X,Y,2 : Wait 1
Goto MAIN
Procedure LOSEP1
  Boom
  Pen 3
  Locate 0,0
  Centre " Good Shot, P2 "

```

```

Locate ,24
Centre " <press a key> "
Inc SCORE2
If SCORE2=>10 Then WIN
Wait Key
End Proc
'
Procedure LOSEP2
  Boom
  Pen 3
  Locate 0,0
  Centre " Good Shot, P1 "
  Locate ,24
  Centre " <press a key> "
  Inc SCORE1
  If SCORE1=>10 Then WIN
  Wait Key
End Proc
'
Procedure WIN
  Pen 3 : Locate 0,0 : Centre " Game
Over " : Boom : Wait 30 : Boom : Wait
30 : Boom
  Pen 2 : Locate 0,0 : Print "P1
";SCORE1 : Locate 34,0 : Print "P2
";SCORE2;" "
  Locate ,24
  Centre " <press a key> "
  WON=1
End Proc
Procedure NOISE
  For L=79 To 0 Step -1
    Play 96-(20+(L/2)),0
    Wait 1
  Next L
End Proc

```

variable definitions and declarations of their Global or Local nature close to the front of the program. To ensure the program works on a NTSC machine as well as PAL, we've made the program limit itself to 200 lines, opening a screen which is 320 pixels wide and 200 deep using the line:

```
Screen Open 0,320,200,16,Lowres
```

A low-resolution screen with 16 colours is easy on memory and simple to set up. You don't have to have this line, because a 16-colour screen in low-res is actually the default. After the customary removal of the Cursor and Pointer with CURS OFF and HIDE, we come across a much more complex piece of code:

```
Set Rainbow 0,0,202,"", "", ""
```

This creates a rainbow effect using the graphics co-processor or copper chip, using the Set Rainbow, Rain and the Rainbow commands. The colour of each line of the display is set to a slightly different colour of 200 shades from the full Amiga palette of 4,096 colours.

The Rainbow is initially set up with the first line as Rainbow 0, which will appear instead of colour 0 (the black background colour), and will be 202-lines long. The empty quotes can also have colour information in them, but we've decided to load the colours in using Rain, as this makes everything that little easier. We also opted to set up a loop to feed the colour infor-

mation to Rain. Because we want 202 lines in this case, we'll make the loop run from 0 to 201:

```
For C=0 To 201
  Rain(0,C)=C
Next C
```

The Rain command accepts the colours 0 to 201, and feeds them to Rainbow 0, on line C and using colour C. So line 0 gets colour 0, line 2 gets colour 2 and line 25 gets colour 25.

These colours are not the same as the palette colours. These are drawn from the entire colour palette of 4,096 colours, explaining why the first 200 are blues and greens. A few stray purples come in at the bottom, but get cut off before they get too interesting. Finally we turn on the Rainbow with the Rainbow command:

```
Rainbow 0,0,49,202
```

which means turn on Rainbow 0, from the base colour 0, display the thing from line 49 on the screen (remember the AMOS screen is much bigger than the monitor screen), and make the visible bit of the Rainbow 202 lines long (by an odd coincidence the same amount of colours that we have in the Rainbow).

The next bit of code is pretty much as it was in the previous program, except that it has been squeezed together by having more than one command on a single line, like so:

```
Double Buffer
Paper 0 : Ink 4 : Bar 0,0 To 5,30
Ink 2 : Polyline 0,30 To 0,0 To 5,0
Get Sprite 1,0,0 To 6,31
Cls 0 : Ink 2 : Circle 5,5,2 : Paint
5,5
Get Sprite 2,0,0 To 10,10
```

You could string them all together to make one big line, but that makes the line that much harder to read. Those lines basically draw the sprites on screen and grab them as detailed in last month's tutorial, except this time with different colours. Next we have a label:

```
TITLE:
```

which we will be using later on in the program to send the game back to the title screen. This is the why in the next line we say:

```
Bob Off 1 : Bob Off 2 : Bob Off 3
```

when there aren't any Bobs turned on yet! When the program returns to this point from the end of the game, the Bobs 1, 2 and 3 are all turned on and just clearing the screen doesn't get rid of them. You have to turn them off by hand. Again the rest of this part of the program is largely the same, apart from using the colon to put lines together and changing the colours and text.

Continued overleaf

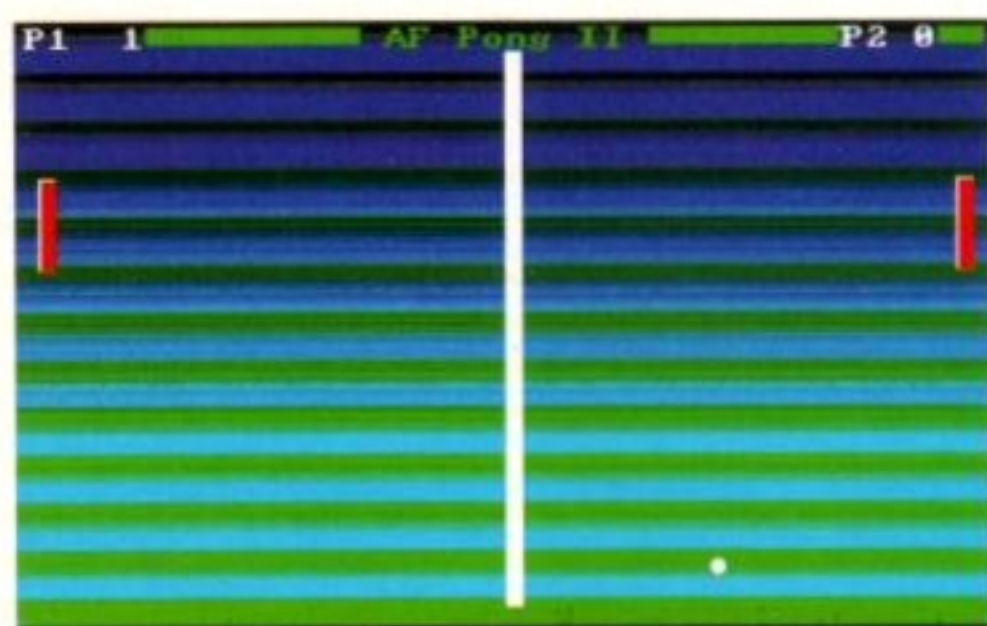

The game runs at exactly the same speed as in the arcade. It's amazing how quickly technology ages.

```

Cls 0 : Pen 2
Locate ,7 : Centre "Amiga Format"
Locate ,9 : Centre "Presents"
Pen 3 : Locate ,11 : Centre "A F P O
N G I I"
Pen 2 : Locate ,13 : Centre "The
Sequel"
Locate ,24 : Pen 2 : Centre "<press a
key>"
    
```

But the next bit is where we zero the variables. Why here? Well that's because we want to set the scores back to 0 after the game rather than later or in the previous routines which set up the basic bits of the game.

```
WON=0 : SCORE1=0 : SCORE2=0
```

After that we make a noise and off we go into the main guts of the program.

```
Wave 0 To 15 : NOISE : Wait Key
```

First thing we do when we restart the game is to check to see if anyone won after that last round. We do this by checking to see if the variable WON is equal to 1. If it is:

```

RESTART:
If WON=1 Then Goto TITLE
    
```

Then we go to the label title and start afresh. If not, then we plough into resetting the game and starting the next round:

```

Cls 0
Ink 11 : Bar 0,0 To 319,5 : Bar 0,194
To 319,199
Ink 2 : Bar 160,0 To 165,193
Pen 5 : Locate 0,0 : Centre " AF Pong
II "
    
```

which is largely the same as it was in the last program, until the bit where we go:

```

Pen 2 : Locate 0,0 : Print "P1 ";SCORE1
: Locate 34,0 : Print "P2 ";SCORE2;" "
    
```

which prints the new scores on the screen using the Locate command to ensure that the player 1 score goes

TAKE CONTROL

If you are planning to use AMOS to control some external hardware devices, check out the listing on the Coverdisk (in the Serious Stuff drawer) and also the explanation on Page 190. You will need to build some electronic circuitry - but it's well worth that extra effort.

TECH HELP

If you have any initial problems with your AMOS disk or technical problems with AMOS itself, phone Europress Software on 0625 859333 and ask for the Technical Help Dept. They wrote the program so they should have the answers.

Additional software support is available from the AMOS Club, 1 Lower Moor, Whiddon Valley, Barnstaple, North Devon EX32 8NW. Send them your name and address, and £12 per year (£15 overseas) and you will get six issues of the newsletter full of AMOS hints and tips, plus a technical help telephone number you can call if you need help to figure out any problems you have with your AMOS programs.

Club members also have discounts on AMOS software, particularly from Shadow Software like CText and SpriteX.

on the left, and the player 2 score goes on the right. There is a space after the player 2 score to make sure that there are no bits left on the screen from a previous score or any bits of the Bar showing through. Next the vectors which control the initial ball speed and direction are set up:

```

X=150 : Y=100
Y1=50 : Y2=50
DX=Rnd(4)+2 : DY=Rnd(2)+1
R1=Rnd(10) : If R1>5 Then DX=-DX
R2=Rnd(10) : If R2>5 Then DY=-DY
    
```

and then we are into the main program loop.

```

MAIN:
Add X,DX : Add Y,DY : If Y<=5 or Y>=190
Then DY=-DY
Z1=Bob Col(1) : Z2=Bob Col(2) : If Bob
Col(4) Then DX=-DX
If X<=-20 Then LOSEP1 : Goto RESTART
If X>=320 Then LOSEP2 : Goto RESTART
If Z1<>0 Then DX=-DX : DX=Rnd(5)+3 :
Shoot
If Z2<>0 Then DX=Rnd(5)+3 : DX=-DX :
Shoot
    
```

The main difference here is that there are two different losing procedures, one of which scores a point for player 1, and the other of which scores a point for player 2. Obviously if the ball hits player 1's end zone this sets off LOSEP1, which gives a point to player 2. The other difference is that when the collision detection routine causes the ball to bounce off the bats, the shot sound is heard.

One of the major differences comes next. This is the joystick-detection routine, and this reads the sticks in ports one and two and sends the info to the bats.

```

If Joy(1) and 2 Then Y1=Y1+6 : If
Y1>165 Then Y1=165
If Joy(1) and 1 Then Y1=Y1-6 : If Y1<5
Then Y1=5
If Joy(0) and 2 Then Y2=Y2+6 : If
Y2>165 Then Y2=165
If Joy(0) and 1 Then Y2=Y2-6 : If Y2<5
Then Y2=5
Bob 1,5,Y1,1 : Bob 2,310,Y2,1 : Bob
3,X,Y,2 : Wait 1
Goto MAIN
    
```

The variables Y1 and Y2 are the vertical position of the two bat sprites, bob 1 and bob 2. The bit on the end of each line limits the bats to line 5 at the top and line

FURTHER READING

If you want to read more about AMOS and how to get the most out of it, obviously we'd strongly recommend that you get the manual and examples disk from our mail order pages (try looking on Page 174). It's a snip at £13.95.

There are also a wealth of helpful books on the topic out at the moment. We'd suggest that you try reading Phil South's *Mastering Amiga AMOS* (Bruce Smith Books 0923 894366), which is a fine beginner's guide.

Other books which come highly recommended are the very excellent *Amiga Game Maker's Manual* by Stephen Hill (published by Sigma Press 0625 531035) and *AMOS In Action* by Len and Anne Tucker, (published by Kuma Computers 0734 844335) which covers just about every conceivable aspect of AMOS.

165 at the bottom, meaning that the bats don't overlap the edges of the court.

Finally we have the procedures which we call during the program. The LOSEP1 sets off a BOOM sound and print "Good Shot Player <whatever>", and prompt you to press a key.

```

Procedure LOSEP1
Boom
Pen 3
Locate 0,0 `
Centre " Good Shot, P2 "
Locate ,24
Centre " <press a key> "
Inc SCORE2
If SCORE2=>10 Then WIN
Wait Key
End Proc
    
```

If the score is equal to or greater than 10, then the player who got that score wins the game, and we are sent off to the procedure called WIN:

```

Procedure WIN
Pen 3 : Locate 0,0 : Centre " Game
Over " : Boom : Wait 30 : Boom : Wait
30 : Boom
Pen 2 : Locate 0,0 : Print "P1
";SCORE1 : Locate 34,0 : Print "P2
";SCORE2;" "
Locate ,24
Centre " <press a key> "
WON=1
End Proc
    
```

This prints GAME OVER and booms three times to emphasise the fact that the game is over. It will print the final scores and give the winning player time to gloat before you restart the game and begin anew.

And that's that. A simple revision to the existing listing which makes it an altogether more interesting program. Now not only do you have the competitive element in this program, but you also have something which is easier on the eye and much more what you might call a game.

ANY QUESTIONS

If you have any questions about AMOS send them to:
AMOS Answers
Amiga Format
 30 Monmouth Street
 Bath, Avon BA1 2BW

BUILD MUSCLES FAST

YOU CAN BUILD A FANTASTIC POWER PACKED BODY IN ONLY 12 WEEKS!

NEW! Fastest and best way to build muscles and strength without weights - **EVER! SCIENTIFICALLY PROVEN.** Just 20 minutes daily in the privacy of your home will develop an amazing physique.

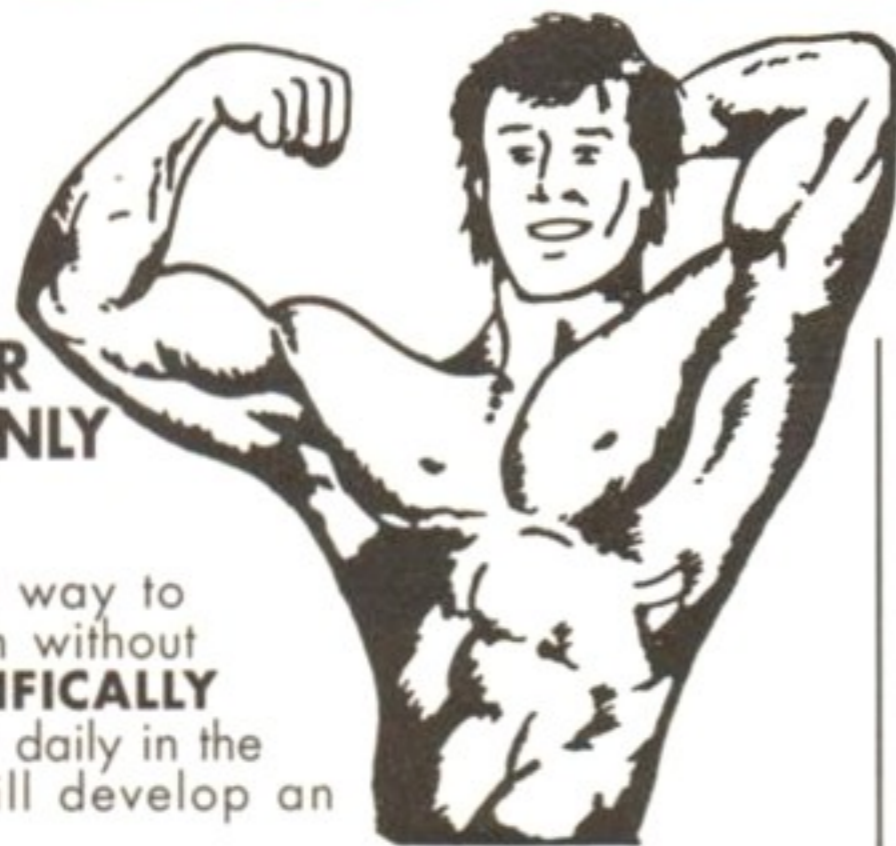

MUSCLE DYNAMICS is a new bodybuilding system based on principals developed after years of exhaustive research. It is a total exercise programme involving the very latest scientific breakthroughs in the field of muscular development. It is the fastest, most effective way to build muscles in existence.

NOTICEABLE RESULTS IN 28 DAYS GUARANTEED
Send for exciting **FREE** information pack today

MUSCLE DYNAMICS (AF)
PO BOX 70, DOUGLAS, ISLE OF MAN

Yes! I want to build muscles fast. Please rush me my **FREE** information pack!

Name

Address

Postcode

(A Stamp for reply appreciated)



NEW

AMIGA A600 & (HD) CONSOLE UNIT

Monitor console and keyboard unit ● Second drive space ● No hard drive restrictions ● Power supply space ● Keeps cables tidy ● Non-magnetic aluminium ● High quality texture finish ● Plenty of ventilation ● Installed in minutes ● Designed specifically for the A600 and A600HD
A REAL SPACE SAVER! - KEEPS EVERYTHING REALLY TIDY

Only £34.95 incl P&P



Only £34.95 incl P&P

AMIGA A500 AND PLUS CONSOLE UNIT

Monitor console and keyboard unit ● Second drive space ● No hard drive restrictions ● Power supply or modulator space ● Keeps cables tidy ● Non-magnetic aluminium ● High quality texture finish ● Plenty of ventilation ● Installed in minutes ● Designed specifically for the A500 and 500+ ● Colour coordinated.

A real space saver! - Over 1,000 satisfied customers



Only £37.50 incl P&P

NEW

A1200 CONSOLE UNIT

Monitor console and keyboard unit ● Second drive space ● Power supply space ● Keeps cables tidy ● Non-magnetic aluminium ● High quality texture finish ● Plenty of ventilation ● Installed in minutes ● Designed specifically for the A1200.

KONTAX COMPUTERS

11a Waldeck House, Waldeck Road, Maidenhead SL6 8BR

0628 773212

Phone lines manned between 8.00am - 9pm (No ansaphone!)

ONE PIECE DUST COVER ALSO AVAILABLE - PLEASE CALL

AMERICA'S LARGEST SUPPLIER OF AMIGA CUSTOM CHIPS + UPGRADES

● MICROCARD 601 FAST RAM PCMCIA MEMORY CARD ●

Microcard 601 by Microworks Ltd. offers up to 4 additional megabytes of FAST RAM via the A600/A1200 PCMCIA slot. This credit card sized memory module auto-configures at boot time, leaving most of the internal chip RAM free for image processing. No hardware or software configurations are needed and recognition is automatic. Microcard 601 is available as PCMCIA memory modules in 2 and 4 megs at the lowest price available anywhere.

2 megabyte upgrade PCMCIA card£105.00
4 megabyte upgrade PCMCIA card£145.00

● ADVANCED AMIGA ANALYSER ● by Wilcom Australia Ltd.

A complete diagnostic hardware and software analyser for all Amigas. Gives display status of all data transmission/signals, the ability to test the integrity of any disk drive, checks all ports, buffer chips, alignment and joystick/mouse. Reads diagnostic status of any read/write errors from track 0 to track 79. Software automatically tells what errors are found and the chips responsible. 85% to 90% of the problems presented to service centers are found with this analyser. It will save you lots of money on repairs. No repair shop can afford to be without one. Don't be fooled by its low cost. Simply plug the cables into any Amiga port. This is a sophisticated diagnostic unit used by Amiga repair centers worldwide£52.50

● SWITCH ITT - 1.3/2.0 ROM SELECTOR ●

TOP SELLING electronic ROM selector by Global Upgrades, Inc. allows for compatibility of ALL your software. Automatically switch between 1.3 or 2.0 ROM from your keyboard. Built-in speaker. Does not overlap the 68000 chip. No soldering. Lowest priced keyboard switch available. Instructions included£19.00

- Buy the Switch Itt with the 1.3 ROM upgrade @ £33.00
- Buy the Switch Itt with the 2.05 ROM upgrade @ £39.00
- **The Ultimate Deal:** Buy the Switch Itt with the 1.3 and 2.05 @ £55.75

● 2.05 ROM CHIP ●

NEW, latest revision for high density drives, PCMCIA slot, etc. Just released.....£26.50

● AMIGA TROUBLESHOOTER ●

Released Jan. 1993, a unique troubleshooting guide for the Amiga 500/2000 with a cure rate of over 95 percent. This diagnostic tool will truly save you lots of money and down time by showing you which plug-in chips to change. It's quick and easy to use£10.50

● AMIGA CHIPS ●

1.3 Kickstart ROM£16.50 6570-036 keyboard control chip.....£6.55
8520 CIA (2MHz)£6.55 8373 Super Denise.....£19.75

DEALERS - SEND YOUR LETTERHEAD FOR SPECIAL PRICING

THE GRAPEVINE GROUP INC.

3 Chestnut Street, Suffern, New York 10901 U.S.A.

International Fax: 0101-914-357-6243

Customer Order Line: 0101-914-357 2424

Telephone Hours: 1pm to 11pm Mon-Fri, British time

Prices subject to change. **International Orders:** If your order is over £40 send or fax front of credit card. Shipping & Handling £9.00



Prices now include VAT, customs and duty if any

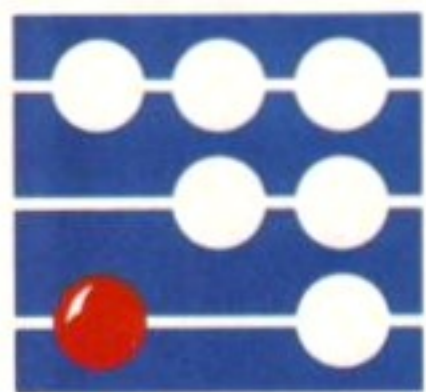

CALCULUS

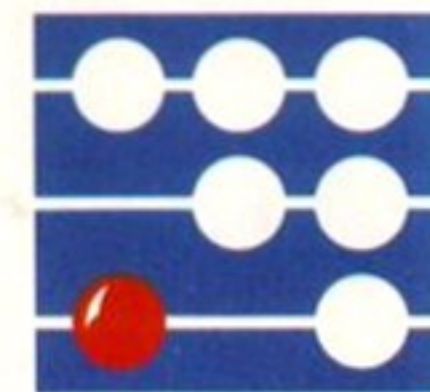

C O M P U T E R S T O R E S

FOR YOUR LOCAL
CALCULUS STORE

TEL: 0543 251275

Phone lines open 9.30am to 5.00pm (Monday to Friday)
and 9.30am to 4.30pm (Saturdays)

EXCLUSIVE
PACK

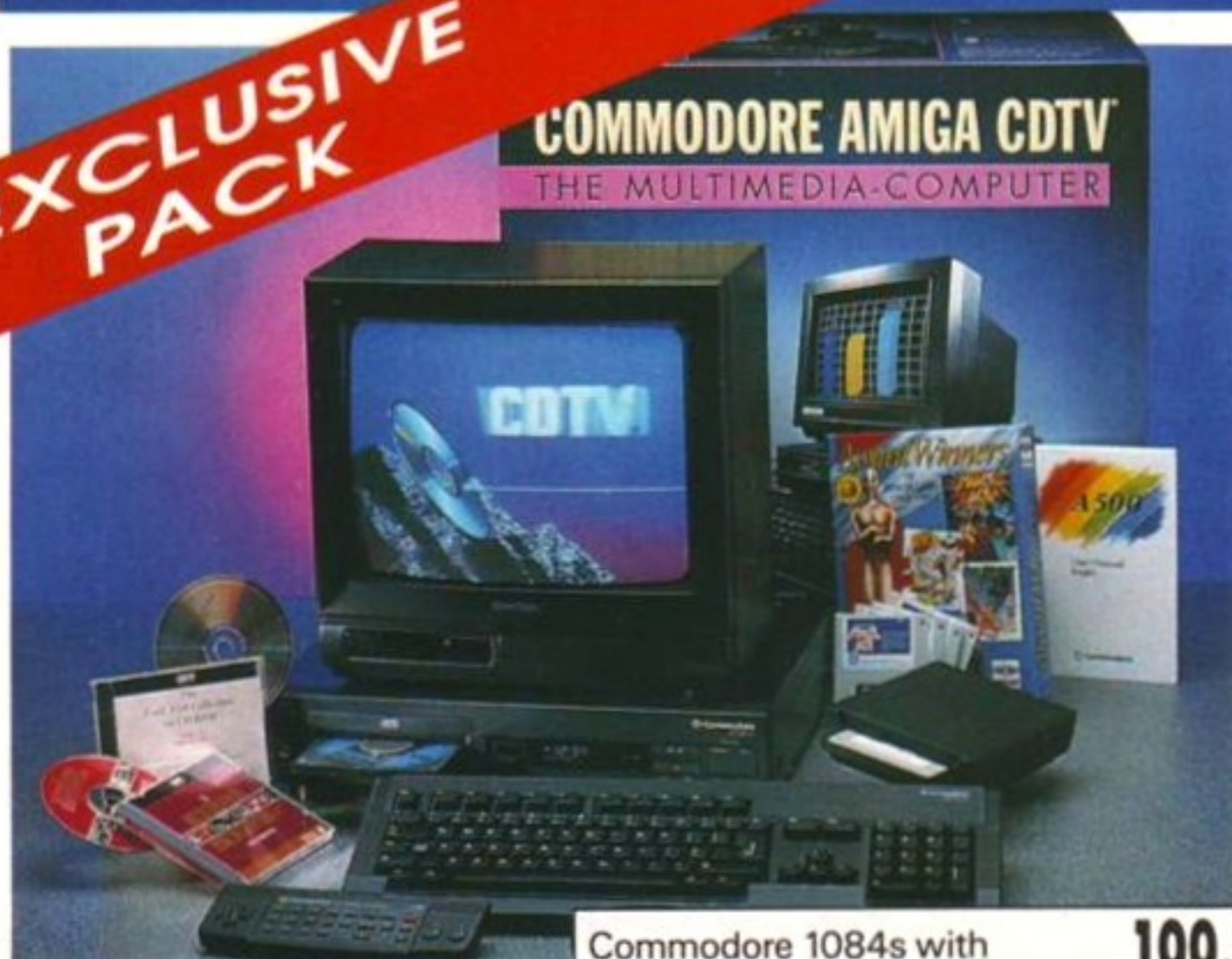

COMMODORE AMIGA CDTV
THE MULTIMEDIA COMPUTER

Commodore 1084s with
matching black finish available at **199.99**

AMIGA CDTV MULTIMEDIA PACK

The all new Amiga Multi Media value pack is only available from Calculus. Another first for the UK's largest computer group.

- Amiga CDTV
- CDTV 1411 3.5" Disk Drive
- CDTV Welcome Disk
- CDTV Keyboard
- Infra Red Remote Control for Amiga Software
- CDTV Wired Mouse
- Fred Fish Disk

FREE Hutchinsons Encyclopaedia CDTV title worth £49.99

FREE Award Winners 4 top games pack worth £122.52

Pipemania, Space Ace, Kickoff 2 and Populous.

*Photograph shows Goldstar Monitor, not included.

CALCULUS
PRICE

£469.99

THE LATEST AMAZING
COMMODORE BUNDLES



COMMODORE PC'S BUSINESS & LEISURE BUNDLES

From the UK's largest Home Computer manufacturer, comes a range of business machines which will make your hair stand on end... and then help you let it down! From 386sx-25 to 486dx-66, Commodore offer superb engineering and a highly competitive price/performance ratio. So whether it's a letter to the tax man or playing PAC Man, all you have to do is choose the processor.

CALCULUS
PRICE

386sx-25 Leisure Bundle £799.99

486slc-25 Leisure Bundle £899.99

Leisure Bundle includes: Front End Menu System, Soundblaster II Compatible Card, Stereo Speakers, Wing Commander II, Legend and DeGeneration.

CALCULUS
PRICE

386sx-25 Business Bundle £799.99

486slc-25 Business Bundle £899.99

Business Bundle Includes: Windows 3.1, Microsoft Works for Windows

All machines come complete with MS.Dos v.5, Mouse, 12 months On-Site Maintenance, CVGA Monitor, 40Mb Hard Disk, 3.5" Floppy Disk, AT Style Keyboard and full manuals.

COMMODORE MPS 1270A



This must be the best value Ink Jet printer on the market. Whisper quiet yet still achieving an amazing 160 CPS. The MPS 1270A is fully compatible with the CBM 64, Amiga 600 and A1200.

R.R.P. £149.99

CALCULUS
PRICE

£99.99

EXCLUSIVE OFFER

PHONE 0543 251275... FOR YOUR LOCAL STORE... PHONE 0543 251275... F

**THE FIRST DEDICATED CALCULUS STORES NOW OPEN PHONE 0543 251275
TO FIND THE NEAREST ONE TO YOU**

AMIGA 1500 STARTER PACK

FREE AMIGA VISION
WORTH £90 WITH
EACH AMIGA 1500

NEW
AMIGA 1500
FEATURING
WORKBENCH 2
KICKSTART 2



- **AMIGA 1500 'CALCULUS' STARTER PACK** Amiga 1500 Dual Drive, 1Mb RAM Mouse, Manuals and Amiga DOS.
- **THE WORKS – PLATINUM EDITION** A full integrated software package with Word Processor (inc. English Dictionary) Spreadsheet and Database Package.
- **DELUXE PAINT III** Probably the best paint package available, allowing you to display your hidden talents. This award winning software allows you to paint, design or animate.
- **HOME ACCOUNTS** Home accounts with budgeting, forecasting and graphics.
- **ELF** – You will encounter Cornelius the Elf on your travels in the mystical lands of Gooks and Goblins. Weird villainous creatures and devious puzzles test your gameplay techniques and gnostic powers.
- **TOKI** – The arcade sensation that swept the world. Toki has been transformed into a monkey by the evil wizard. He must now try to regain his manhood and rescue his beloved princess Miho. Join Toki on his mythical adventure, full of demons and deadly witchcraft.
- **PUZZNIC** – A puzzle game to top them all. It's fast, furious and devilishly addictive. With 144 levels, the action never stops.

PREVIOUS
CALCULUS PRICE
£529.99

SPECIAL OFFER
£469.99

BUILT
IN TILT
& SWIVEL
STAND

AMIGA 1084ST STEREO

MONITOR



MASSIVE PRICE REDUCTION

Commodore's original and best-selling stereo monitor is fully compatible with all Amiga products and gives your system the total Commodore look.

- With our new Calculus price the 1084ST has never been better value.
- Stereo Sound
 - High Resolution Display
 - Ergonomic Design
 - Full Amiga Connectivity pack
 - Compatible with all Amiga products

RRP £299.99
CALCULUS PRICE

£189.99

PANASONIC KX-P2180

COLOUR PRINTER



The new Panasonic KX-P2180 9 pin quiet colour printer. Produces crisp clear text in mono or in 7 glorious colours with new quiet technology. The new KX-P2180 is typically 15dBA quieter in operation, than the competition.

- **Fast Printing Speeds** 192CPS Draft and 38 CPS NLQ
- **Colour Printing** 7 colour palette (blue, red, green, yellow, violet, magenta and black)
- **QuietPrinting** Super quiet 45-48dBA sound level (most matrix printers are typically in excess of 60dBA)
- **6 Resident Fonts** Over 6,100 type styles using Courier, Prestige, Bold PS, Roman, Script and Sans Serif Fonts
- **3 Paper Paths** Paper handling from bottom, top and rear for total flexibility
- **1 Year Warranty** For total peace of mind

CALCULUS
PRICE

£199.99

PANASONIC KX-P2123

COLOUR PRINTER



The new high performance Panasonic KX-P2123 24 pin. Quiet colour printer offers leading edge quiet printing technology at an affordable price.

- **Fast Printing Speeds** 192 CPS draft, 64 CPS LQ and 32 CP SLQ.
- **Colour Printing** 7 colour palette (blue, red, green, yellow, violet, magenta and black)
- **QuietPrinting** Super quiet 43.5-46kBA sound level (most matrix printers are typically in excess of 60dBA)
- **7 Resident Fonts** Over 152,000 type styles using Super LQ, Courier Prestige, Bold PS, Roman, Script and Sans Serif Fonts
- **24 PIN Diamond Printhead** High performance and high quality output
- **1 Year Warranty** for total peace of mind.

CALCULUS
PRICE

£229.99

FOR YOUR LOCAL STORE... PHONE 0543 251275... FOR YOUR LOCAL STORE...

ITEMS HELD IN STOCK MAY VARY FROM STORE TO STORE. ALL CALCULUS OFFERS ARE FOR THE MONTH OF PUBLICATION ONLY.

Chart busters



STREETFIGHTER 2

Aha, those of you who are really jealous of your SNES owning friends because they can play the cheat *Streetfighter 2* Championship Edition, sulk no more! All you have to do is simply pause the game then type in 7KIDS. The screen will flash yellow, then you can fight two of the same players against each other, such as Ken vs Ken or Blanka vs Blanka, or any other combination of players you like!

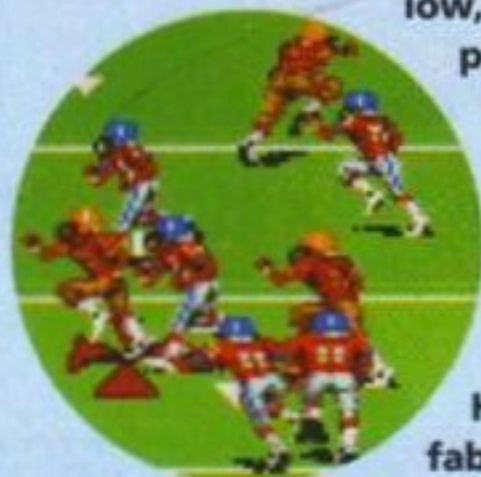

JOHN MADDEN'S AMERICAN FOOTBALL

Here are some level codes for this fabulous game:

Round 2 - 6647600
Round 3 - 6257651
Final - 6657657



HUMANS

After the first 10 level codes last month, we received lots of letters asking for the others - here they are:

- | | |
|-----------------|--------------------|
| 15 RED DWARF | 50 RANGERS |
| 20 SMART | 55 CONSOLIDATED |
| 25 JIMS TIES | 60 PROMISED LAND |
| 30 MALCY MALC | 65 A34732473 |
| 35 MAD FREDDY | 70 NIN |
| 40 BANANNA MOON | 75 LORDS OF CHAOS |
| 45 VISION | 80 BYE BYE BYE BYE |

Game Busters

And Lo, once more **Andy Nuttall**, the Buster of Games comes unto your lives, bringing you joy and peace and everlasting love for all men. Oh, and giving you a hand with a few games as well...

PLAY ON YOUR FANTASIES... AGAIN

£25

Although we printed six cheats for 21st Century's stunning *Pinball Fantasies* last month, here are some other interesting words for you to type in before you select the number of players...



I'd like to speak to Teeth, please...

- | | |
|-------------|---------|
| ANDREAS | FREDRIK |
| ULF | OLOF |
| MARKUS | BARRY |
| TECH STUFF | CREW |
| THE SILENTS | |

And the first lucky winner of a £25 gift voucher this month is...

Magnus Lundberg
Täby, Sweden

£50

The new release of Team 17's classic shoot-em-up *Alien Breed*, the '92 version, has caused a stir with GameBuster followers. Loads of you have sent the five level codes in, but one reader offered some more thorough information...



Aliens getting you down? You need the all-new level codes, mate. They'll see you right.

LEVEL CODES:
Level 2 - XXDFA
Level 4 - RTHAA
Level 6 - LAEEA
Level 8 - UYTТА
Level 10 - PPEAB

According to the lads at Team 17, the following cheats "Do something or other"...

WON THE POOLS
BANK RAID
KEY TO THE CITY
MR YALE OR WHAT

IN BANGOR, NO-ONE CAN HEAR YOU SCREAM...

JUST CALL ME MOGGY
WHY NOT CALL ME MOGGY AS WELL
STEVIE WONDER
KNACKERED JOYSTICK
ALIENS LIKE MICHAEL BOLTON
JANUARY SALE NOW ON
ALIENS ARE BENDERS
ST EMULATOR
PC EMULATOR
I JUST LOVE THAT TEAM 17 SOFTWARE
SALMAN RUSHDIE PLAYS ALIEN BREED
THE IRAQIS MADE THE WEAPONS
ELVIS MODE
ST USERS

GAME TIPS:

- Using codes to help finish the game doesn't always work - some things are required from earlier levels. Collect everything (especially money).
 - You don't need to go through any doors that lead to the first-deck lift.
 - Conserve your keys. Use them for accessing the landing bays first, then go for bonuses behind other locked doors. Blast open the doors near the lower bay, and shoot as few aliens as possible.
 - Once you've run out of keys, you should have almost all the money available on the first level. Go to the computer and buy the following items:
1. A portable map

2. Two key packs, or three if your aim is good - on level 10 you'll need all the ammo you can get.
3. If you have more than 2,000 credits spare, buy some more magazines.

Remember: to buy any object twice, you need to leave the computer network, then reconnect. Always buy what you need before you enter a level code.

LEVEL 10: The third-to-last level is rather difficult, because you need to carefully plot your route back to where you started from. Here, you'll need all the key packs you bought earlier.

LEVEL 11: Very easy, as long as you have loads of ammo. Use your map often, and don't bump into any walls - otherwise the ship-destruct countdown will begin and you'll have to reach the deck lift very quickly...

LEVEL 12: The final level. You can't use your map here, and there are no computers, so this is a real test of skill. The queen may be reached by going up through the long corridor with the meshed floor, then by going down and right. When you have killed her, the deck-lift will be to your right.

The massively fortunate Robin Jones of sunny Bangor wins a £50 voucher for sending in these tips.

Legend of Kyrandia



After a successful stint as RPG creators with their Eye of the Beholder series, Westwood Studios attempted to topple LucasArts from their position as adventure makers extraordinaire. Did you manage to defeat the evil Malcolm? No? Then read on...

AMIGA FORMAT

CHAPTER ONE - AT HOME

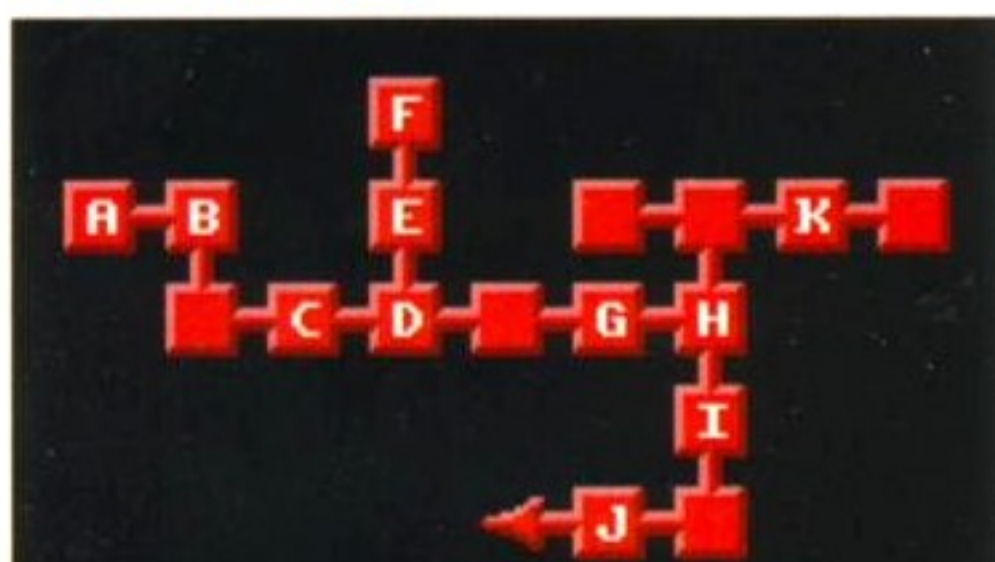

- A - TEMPLE**
- B - OUTSIDE TEMPLE**
- C - WILLOW**
- D - BELOW HOME**
- E - OUTSIDE HOME**
- F - INSIDE HOME**
- G - POOL OF SORROW**
- H - PERIDOT**
- I - HERMAN'S TREE**
- J - RUINED BRIDGE**
- K - SILVER ALTAR**

Uh oh, Malcolm's back... not even the magic of Kyrandia could lock him away for ever, it seems; and now he's turned your grandad, Kallak, into a lump of rock. There's nothing you can do about it, except defeat Malcolm himself (well, there's your ultimate aim - let's do something about it!).

When the Tree Messenger has finished speaking, get the note and the garnet from the workbench, the apple from the pot, and the saw from underneath the



Aaagh! I don't seem to have a reflection! Is this because I'm some kind of hideous vampire-type creature? Or is it an oversight on the part of the artists?

bed. You will find uses for these later, as you will with any gems that you may come across on your travels.

From the tree house, you must find Brynn at the temple. If you give the note to her, she will make an enchanted message appear on it. From this message you will discover about Malcolm, and Brynn will then ask you to bring her a purple rose. You can find the rose at the Forest Altar, but on the way there it's a good idea to grab a teardrop from the Pool of Sorrow. Strangely enough, the teardrop is exactly the same shape as the dent in the Willow's trunk, so use it to heal the sick tree.

Merith will appear at some point - if you follow him and catch up with him, he will give you a purple marble. The marble may be used to repair the Forest Altar by putting it in the empty slot near the two other marbles.

Find Herman at the Ruined Bridge, and give him the saw. He will begin repairing the bridge, but he won't finish until you get an amulet. This you can get by first taking the rose to Brynn, who will change it into a silver. Placing the silver rose on the Forest Altar will cause the amulet to appear. Now Herman will have repaired the bridge, and you can cross the river to the Timbermist Woods.



Aha, the old 'put the gems in the golden bowl' routine, eh? This one's easy when you follow the hints below.

CHAPTER TWO - TIMBERMIST WOODS

Just past Herman's cave is Darm's house, where you will find Darm and Brandywine the dragon. After a bizarre conversation, Darm will ask you to find him a quill. Find the walnut at the songbird's tree, an acorn at the Grove of Oaks and the pine cone in the forest. Then plant all three in the hole in the Deadwood Glade. Nolby, who can be found under the Ancient Oak, will give you a clue - although you'll have to try and decipher it.

Following your attempt at gardening, the resulting plant will activate the yellow healing gem on your amulet. Use this to heal the sick songbird who, in a fit of gratitude, will give you the quill you need to give to Darm. Hand it to him, and he will write you a magic scroll which you will need to get to the castle.

The next quest is the Birthstone. To complete this you will need to find various gems and stones lying around Kyrandia. Darm will summon the stones so that you can see them all, and the first one is the Sunstone, which is in the lower part of the Bubbling Spring. There are nine different stones and gems in the woods, and all these should be collected. They must be placed correctly in the gold dish at the Marble Altar.

The second and third stones vary with each new game. Trial and error, and liberal use of the save option will help here. The fourth stone is the ruby (which can be found at the Ruby Tree), but you will be fatally bitten by the snake if you don't activate the healing gem on your amulet before you leave the Grove of Oaks.

When you've placed the last Birthstone in the golden bowl, the bowl will turn into a flute. If you then return to Darm and Brandywine, they will tell you how to get to Shadowrealm. During your travels you will



- A - OUTSIDE DARM'S**
- B - INSIDE DARM'S**
- C - STATUE**
- D - MARBLE ALTAR**
- E - GROVE OF OAKS**
- F - RUBY TREE**
- G - ANCIENT OAK TREE**
- H - SONGBIRD'S NEST**
- I - WISHING WELL**
- J - BUBBLING SPRING**
- K - DEADWOOD GLADE**
- L - SERPENT'S GROTTA**

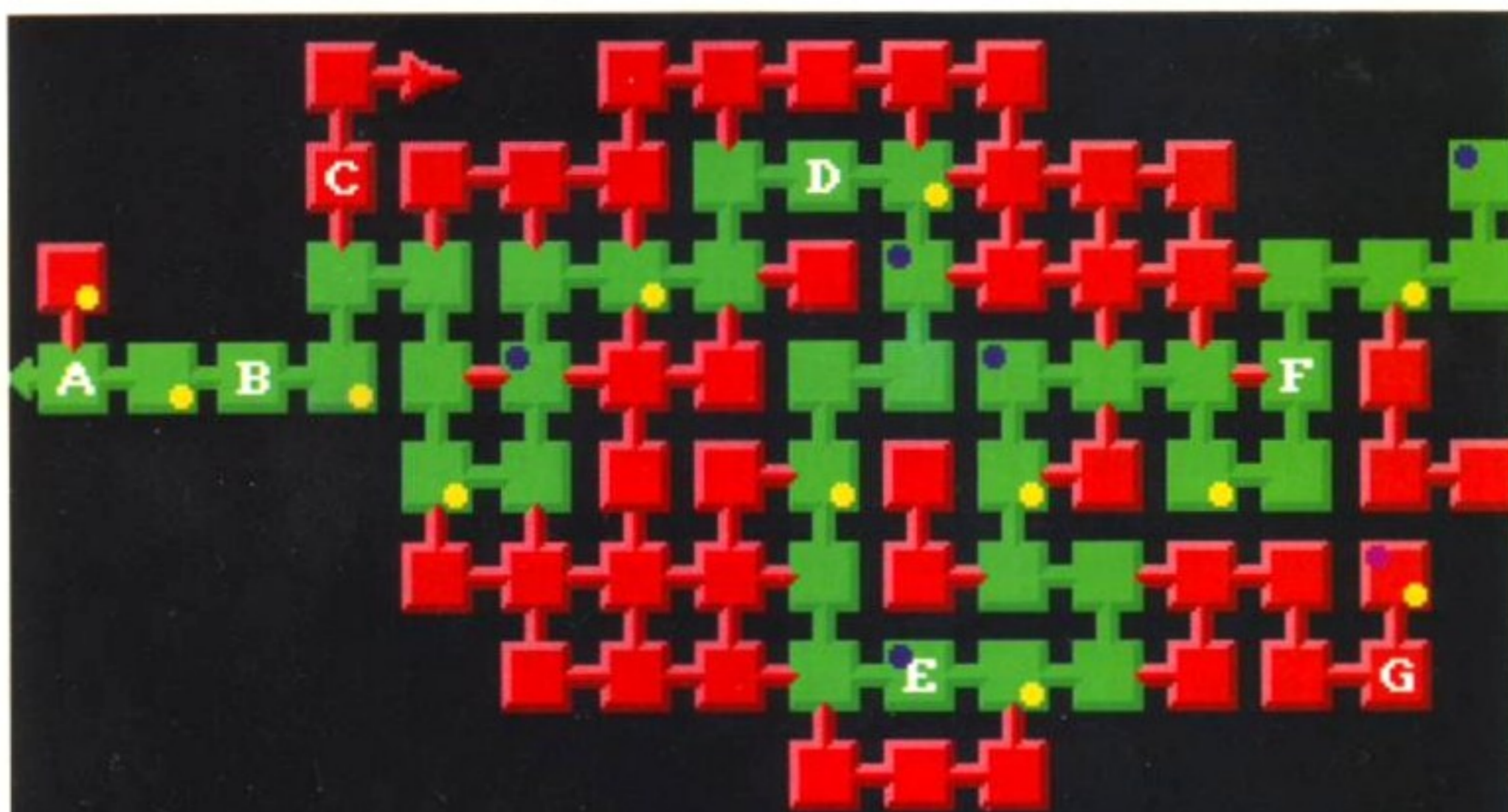

H BEST ROUTE STRAIGHT THROUGH

- FIREBERRY BUSH
- ROCK
- KEY TO CASTLE GATE

- A - MINERAL POOL
- B - IRON GATE
- C - CHASM OF EVERFALL
- D - PANTHEON OF MOONLIGHT
- E - CAVERN OF TWILIGHT
- F - EMERALD CAVE
- G - VOLCANIC RIVER

come across the Serpent's Grotto, where Malcolm will introduce himself by throwing a knife at you. Nice. It will miss, but you will be killed if you don't throw the knife back. Like many bullies, Malcolm will retreat if you stand up to him, but he will first seal up the entrance to the cave with ice. To shatter the ice, play the flute and you will be able to enter the labyrinth of Shadowrealm.

CHAPTER THREE - SHADOWREALM

Shadowrealm is a huge labyrinth made up of caverns connected with a variety of entrances and exits. Some of the caverns contain fireberry bushes which may be picked up and used to light your way. If you enter a cave without any fireberries, you will be attacked by the shadow wraiths and die.

Fireberries only last for three caverns when carried, but you can leave them on the ground to light caves as markers. You must work your way through the labyrinth from one bush to another. The map shows the most direct route to take.

Once you cross the cavern with the iron gate, the gate will imprison you in the labyrinth. To open it, you need to collect rocks strewn throughout the caverns. There are five rocks, and you must find them all and throw them into the counterbalance. The locations of the rocks are shown on the map.

To cross the Chasm of Everfall and enter Faeriewood, you need to complete the Pantheon of Moonlight by picking up the coin in the Cavern of Twilight, and dropping it into the wishing well near Darm's house. When you throw the coin into the well, a moonstone will appear. To complete the Pantheon of



The serene beauty of the twilight, the soft sound of the sea, the brutal grating of Brandon's moaning...

Moonlight, place the moonstone in the pedestal base, and the purple gem of the amulet will be activated. Using this gem will enable you to float about in the labyrinth without the aid of fireberries.

Before crossing the Chasm of Everfall, find the key which is in a cavern across the Volcanic River. This may be found to the right of the Chasm of Everfall, but can only be crossed when you're in will-o-wisp form. Freeze the Volcanic River by reading Darm's scroll.

Also, it is useful to pick up an emerald from the Emerald Cave as you will need one later on. Using the will-o-wisp, float across the Chasm of Everfall, and enter Faeriewood - to meet Zanthia the Alchemist.

Will Brandon survive Faeriewood? Will Malcolm push him a little too far? Who is the mysterious Zanthia? And is Kallak all that he seems? (Well, yes he is actually - but you have to try to make him sound windswept and interesting, don't you?)

OH NO! IT'S THE PATHETIC TIPS!

Taken from the thousands of GameBusters letters we receive each month in **Amiga Format**, we choose the funniest or most bizarre and give them a special box of their own. Read on at your peril...



Bill's a 'sucker' for his 'fans' - they're a 'platform' for his 'escalating' success... (Crap Jokes 'R' Us.)

John Gennett of Glasgow was among several readers who offered level codes for Psygnosis' popular *Bill's Tomato Game*. Thanks, lads, but you haven't realised that each copy of the game has its own personalised set of codes - so they won't work on anyone else's version. Nice try, though.



Who on Earth wore dungarees in ancient Byzantium? Apparently this guy did.

Megalomaniac of the month award goes to Mick Walsh of Leicester, who's a fan of MicroProse's strategy game *Civilization*. He writes: "Having just won my fourth King level in a row against seven enemies, and seeing the message: 'Your civilization has conquered the entire planet,' I feel qualified to offer this hint: NEVER FEAR TO USE NUCLEAR WEAPONS WHOLESALE. LET THE FEAR BE YOUR ENEMIES." Er, yes Mick. Trained in the Saddam Hussein school of diplomacy, were we?

That's enough crap tips for one issue, I think... join us again next month.

MONKEYING AROUND ONCE MORE...

Oh, incidentally, remember Jonny Reed's crap tip last month concerning *Monkey Island 2*? You know, the one where you hold down both Alt keys and both Amiga keys, and you are asked if you wish to win?

Well, since then Matt and Annie Bowman from Liverpool have pointed out that if you hold down Alt and hit W, you are in fact asked 'Do you want to win?'. This is still extremely bizarre, but it does actually work. Those crazy people at LucasArts, eh?

Congratulations to the lucky pair, who win a couple of extra-special *Amiga Format* enamel badges for pointing this out.

That's definitely it for now - byeeeee!



Helping Hand

Blimey heck! The months fly by, don't they? It only seems like a month since the last page full of game tips and queries. (That's because it has only been a month since the last Helping Hand – Ed.) **Andy Nuttall** is this month's Master of Ceremonies...

AMIGA FORMAT

124

MARCH 1993

MAKE AN APE OF YOURSELF



I recently read your solution to *Monkey Island 2*. Unfortunately, though, I am stuck at Captain Rum's place, and I can't seem to switch the

Ooer! It seems that Rum's been getting some of you down...

grog. Can you give me a more detailed description of how to do it please?

Chris McArthur
Scarborough

I'm stuck in Captain Rum's cottage! I have all the necessary items, and I've followed your instructions, but I still end up with one hell of a hangover on the beach... can you help?

Mike Keyworth
Redditch

Yeah, of course we can. When you're setting Kate free, get the near-grog from the shelves behind the jail cell. Later on, when you're in Captain Rum's house, talk to him for a while and challenge him to a fight. He'll challenge you to a grog-drinking contest, and he'll then go out to get some mugs. When he returns with a mug of grog, and then leaves again, empty the grog into the bush at the back of the room. Replace it with the near-grog, then let the contest begin!

Taidgh the high road

Please can you help me with *Lure of the Temptress*. I cannot find Taidgh – do you know where he is?

R Burnley
Stamford



Ha, ha. Just joking, sir. Didn't mean it, your largeness. Oh dear, ground swallow me up.

I seem to have run into a few problems with *Lure of the Temptress*. I can get into the Weregate, and get through the first cave room. I arrive at a green room, but I can't open the door to the third room. I've tried twisting the skulls in the second room, but to no avail. If I win, can you send me *Loom* by LucasArts?

Peter Donaldson
Hartlepool

Taidgh isn't actually in the game, you just need to know who he is and where he lives.

In the green cave beyond Weregate, tell Goewin to pull the right-hand skull then go through the door on the left when it opens. Ta-daaaa.

By the way, Peter, we don't give prizes for questions in *Helping Hand*, only answers. Nice try, though!

For God's sake

Help! I'm having difficulty finding a solution for *Gods*. Could you give me a cheat for infinite lives or energy?

Peter Donnelly
Perth, Australia

Here's a tip from Alex Barley: 1) On level two, buy a shield and magic potion, then get three fireballs and three stars. Spend the rest of your money on food and health, then collect all of the gems in the usual manner. Get a key, then make for the exit – make sure that you don't have enough energy to survive the first contact.

Before descending the ladder, release your magic potion, climb down and open the door. Stand in front of the door, but don't push up. Wait until the thieves jump down at you, then push the joystick up. You will probably lose that life, but your bonus will start to increase. The game will then start on world two with 28 extra men and around five million points. Rich enough for ya?

Stop that, it's silly

I have just bought *Sensible Soccer* 1993 edition. As I let my seven-year-old son play it, I thought I had better back-up the disks, but when I try I get the message 'not a DOS disk'. Is it not possible to back-up these disks?

Also, in *Curse of Enchantia* I am stuck in the underground caves. I've done most of the tasks, but I can't get out. I think it's something to do with the well.

Alan Micklewright
Oxford

Most commercial software developers build some kind of protection into their disks so that people can't copy them – *Sensible Software* are no different. Unfortunately, it means you can't back-up your disks even for personal use, so you'll just have to trust your original disks.



Hang on a minute, aren't you one of the lemmings? Your in the wrong game, mate.

You're stuck remarkably near the start of *Curse of Enchantia*! No, sorry, this part can be rather confusing. In the cave corridors, you must get all the boulders, then give them to the rock basher. Take the coin, tie the wire to the loops, then take the mud. Wear the helmet, then go into the well room. Throw the coin into the well, then take the helmet and you'll be free.

Electronic jammmmmming

Please would you print a cheat for *Batman* and *Skidoo*. Even some hints would do. Anything. Help.

Thomas Stocks
Parbold

In *Batman*, type JAMMMMMM (and any other Ms which may be necessary) on the title screen until the screen flips over. Now press F10 to skip levels, and other function keys give messages. Type the cheat in again to turn the cheat mode off.

I know of no cheat for *Skidoo*, though. In fact, I've never heard of the game! Can anybody out there help?

Crap Inc

I am a wrestling fan who has recently purchased *WWF European Rampage*. Despite all my efforts, I can't get past *Money Inc* on the second stage. Can you help?

Darren Bailes
Bishop Auckland

You sad, sad man.

MORE TIPS WANTED!

Unfortunately, that's all we have space for here. Keep the letters flooding in, because remember – we read all of them very carefully. As long as you don't send any Action Replay codes we will consider printing any cheats, hints, tips or maps – you may even win a prize! At any rate, we'll be here – same time, same place – next month. See ya then!

If you're stuck on a particular game or have a solution to a letter printed in the magazine, then write it down and send it in to us at **HELPING HAND Amiga Format, 30 Monmouth Street, Bath BA1 2BW.**

NOW A FULL COLOUR HANDY SCANNER FOR YOUR AMIGA

AT AN UNBEATABLE PRICE!!

FOR ONLY **£199.99**

- The NEW Datel Colour Scanner uses the Mustek 8 colour grey scale head to produce 4096 colour images.
- Several modes of operation are available to give 8, 16 or 32 different colour and Ham images as well as 16 grey scales.
- Scan update direct to the screen with direct scrolling and positioning of the scanned image.
- Full colour palette control with Gamma correction.
- Save IFF or Raw files of screen or buffer.

- Runs in 640 x 256 or 320 x 256 screen display.
- Unit plugs into expansion port of Amiga and does not require external power unit..

HIGH RESOLUTION BLACK & WHITE HANDY SCANNER AT AN EVEN LOWER PRICE!

NEW LOWER PRICE

NOW ONLY **£99.99**

- Package includes Handy Scanner, Interface, Power Pack and Scan Edit IV software.

- NEW** IFF Buffer Save 1600 x 1024 pixels, dual buffer, scan matching & view Buffer.
- Unmatched edit/capture facilities & keyboard control not offered by other scanners at this special price.
- NEW** Full keyboard control of most functions.
- An easy to handle Handy Scanner featuring 105 mm scanning width & 400 dpi resolution enables you to scan graphics/text into your Amiga.

- NEW** Includes hard disk transfer to run under Workbench.
- Adjustable switches for brightness/contrast levels.
- NEW** Full sizing menu of scan area.
- Geniscan gives you the ability to scan images, text or graphics & even offers 200 Dpi Dual Scan Mode.
- NEW** Screen grid overlay & configure menu to save parameters. Icon menu to select functions.

- NEW** X, Y position readout & metric sizes.
- Save images in suitable format for most leading packages including PHOTON PAINT, DELUXE PAINT, etc.
- NEW** View window and position control panel.
- Powerful partner for DTP that allows for cut and paste editing of images etc.

COMES WITH **FREE PHOTON PAINT**

GENIUS DIGITIZING TABLET

ADD A PROFESSIONAL TOUCH TO YOUR DRAWING/CAD WORK

- With the Amiga Genitizer Graphics Tablet you can streamline the operation of most graphic or CAD programs.
- The Genitizer Graphics Tablet utilises latest technology to offer up to 100 dpi resolution at the tip of a stylus.
- Complete 9" x 6" digitizing area plus super accurate stylus combine to enable fast, accurate and easy control.
- Works by "mouse emulation" so the Genitizer will work with most packages where mouse input is the usual method - Deluxe Paint, Photon Paint, CAD Packages, etc.
- Supplied with a template for Deluxe Paint.
- Full easy to follow instructions.
- This is the input method used on professional systems - now you can add a new dimension to graphics/CAD.
- Fast input of drawing by "tracing" is made easy - plus "absolute reference" means you can move around the screen many times faster than by a mouse.
- The Genitizer fits in the serial port of your Amiga 500/1000/2000 and "co-exists" with mouse.
- Unlike a mouse, the Tablet gives absolute co-ordinates so that tracking and menu selections are possible from the tablet face.

- A pressure sensitive switch built into the stylus tip activates the Tablet overriding the normal mouse input. When you are not using the Tablet, you have normal mouse control.
- Complete system - Graphics Digitizer Tablet, Stylus, Deluxe Paint Template, Power Adaptor, Test Software, Interface Unit, plus Driver Program - no more to buy!

NOW ONLY **£129.99**

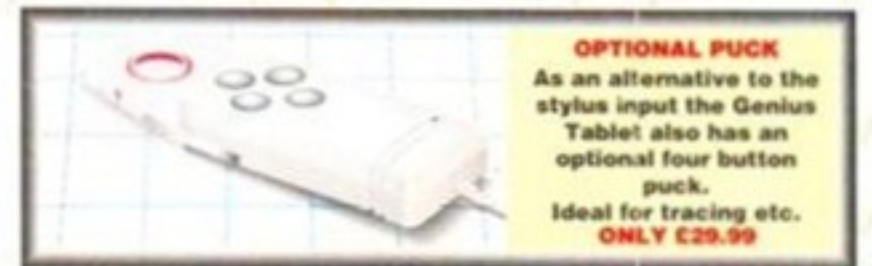

OPTIONAL PUCK
As an alternative to the stylus input the Genius Tablet also has an optional four button puck. Ideal for tracing etc. **ONLY £29.99**

GOLDEN IMAGE OPTICAL REPLACEMENT MOUSE

... NOW A TRUE OPTICAL MOUSE! FOR THE AMIGA

- YES A FULL FEATURE OPTICAL MOUSE FOR YOUR AMIGA - THAT MEANS NO MOVING PARTS!
- Incorporating full optical tracking and counting - no ball so no problems with clogging, slipping, etc.
- High count output for very fine movement.
- Two button microswitch action.
- Comes complete with special "Optical Pad".
- Superbly styled - super-smooth shape moulded to fit the hand.
- Comes complete with moulded 9 pin connector. No more to buy!!

COMPLETE ONLY **£39.99**

GENIUS MOUSE

- High quality direct replacement for mouse on all Amigas.
- Teflon glides for smoother movement.
- Rubber coated ball for minimum slip.
- Optical system counting - 500/mm.

COMPLETE WITH ALL ACCESSORIES ONLY **£19.99**

DATTEL
Electronics
LIMITED

HOW TO GET YOUR ORDER FAST!

TELEPHONE [24Hrs] **0782 744707** CREDIT CARD ORDERS
ORDERS NORMALLY DISPATCHED WITHIN 48 HRS. ALL CHEQUES/POSTAL ORDERS MADE PAYABLE TO...



DATTEL ELECTRONICS



GOVAN ROAD, FENTON INDUSTRIAL ESTATE, FENTON, STOKE-ON-TRENT,
ST4 2RS, ENGLAND. FAX 0782 744292 TECHNICAL/CUSTOMER SERVICE 0782 744324

DATTEL LONDON SHOP



222, TOTTENHAM COURT RD,
LONDON, W1. TEL: 071 5806460

NEW AMIGA



THE WORLDS MOST POWERFUL JUST LOOK AT THE UNMATCHED RANGE OF FEATURES

- SAVE THE ENTIRE PROGRAM IN MEMORY TO DISK.**
Special compacting techniques enable up to 3 programs to fit on one disk. Now saves directly to disk as Amiga Dos - reloads independently of the cartridge - even transfer to hard drive! Works with up to 2 Megs of Ram - even 1 Meg Chip Mem (Fatter Agnus).
- NEW SUPER POWERFUL TRAINER MODE.**
now with DEEP trainer. Even better than before - allows you to generate more or even infinite lives, fuel, ammo. Perfect as a Trainer Mode to get you past that "impossible" level. Easy to use.
- IMPROVED SPRITE EDITOR**
The full Sprite Editor allows you to view/modify the whole sprite set including any "attached" sprites. PLUS A RANGE OF IMPROVED FEATURES.
- VIRUS DETECTION**
Comprehensive virus detection and removal features to protect your software investment. Works with all presently known viruses.
- NEW BURST NIBBLER**
Now this super disk copier program is built into Action Replay Mk III. Just imagine a superfast, efficient disk copier program at the press of a key - no more waiting.
- SAVE PICTURES AND MUSIC TO DISK**
Pictures and sound samples can be saved to disk. Files are saved directly in IFF format suitable for use with all the major graphic and music packages. Samples are displayed as screen waveform.
- NEW PAL or NTSC MODES SELECTABLE.**
Useful for removing ugly borders when using NTSC software. (Works only with newer Agnus chips).
- NEW SLOW MOTION MODE**
Now you can slow down the action to your own pace. Easily adjustable from full speed to 20% speed. Ideal to help you through the tricky parts!
- MANY MORE INSTANT CLI COMMANDS.**
like Rename, Relabel, Copy, etc.
- NEW RESTART THE PROGRAM**
Simply press a key and the program will continue where you left off.
- FULL STATUS REPORTING**
At the press of a key now you can view the Machine Status, including Fast Ram, Chip Ram, RamDisk, Drive Status, etc.
- POWERFUL PICTURE EDITOR**
Now you can manipulate and search for screens throughout memory. Over 50 commands to edit the picture plus unique on screen status "overlay" shows all the information you could ever need to work on screens. No other product comes close to offering such dynamic screen handling of frozen programs!!
- JOYSTICK HANDLER.**
allows the user to select Joystick instead of Keypresses - very useful for many keyboard programs.
- MUSIC SOUND TRACKER**
With Sound Tracker you can find the complete music in programs, demos, etc. and save them to disk. Saves in format suitable for most track player programs. Works with loads of programs!!



HOW TO GET YOUR ORDER FAST!
ALL CHEQUES/POSTAL ORDERS MADE PAYABLE TO.....
DATEL ELECTRONICS
GOVAN ROAD, FENTON INDUSTRIAL ESTATE, FENTON,
STOKE-ON-TRENT, ST4 2RS, ENGLAND. FAX 0782 744292
TECHNICAL/CUSTOMER SERVICE 0782 744324

OR CALL AT OUR LONDON SHOP

ACTION REPLAY

MK III

STILL ONLY

£59.99

AMIGA A500/500+

FOR 1500/2000 VERSION £69.99

FREEZER-UTILITY CARTRIDGE

AUTOFIRE MANAGER

From the Action Replay III preference screen you can now set up autofire from 0 to 100%. Just imagine continuous fire power! Joystick 1 and 2 are set separately for that extra advantage!

NEW

IMPROVED RAM EXPANSION SUPPORT

Now many more external Ram Expansions will work with all Action Replay III commands.

DISKCODER

With the new "Diskcoder" option you can now 'tag' your disks with a unique code that will prevent the disk from being loaded by anyone else. "Tagged" disks will only reload when you enter the code. Very useful for security.

NEW

SET MAP-

allows you to Load/Save/Edit a Keymap.

PREFERENCES

Action Replay III now has screen colour preferences with menu setup. Customise your screens to suit your taste. Very simple to use.

DISK MONITOR

Invaluable disk monitor displays disk information in easy to understand format. Full modify/save options.

IMPROVED PRINTER SUPPORT-

including compressed/small character command.

NEW

DOS COMMANDS

Now you have a selection of DOS commands available at all times - DIR, FORMAT, COPY, DEVICE, etc.

NEW

FILE REQUESTER-

if you enter a command without a filename, then a file requestor is displayed.

DISK COPY

Disk Copy at the press of a button - faster than Dos Copy. No need to load workbench - available at all times.

PLUS IMPROVED DEBUGGER COMMANDS-

including Mem Watch Points and Trace.

NEW

BOOT SELECTOR

Either DFO or DF1 can be selected as the boot drive when working with Amiga Dos disks. Very useful to be able to boot from your external drive.

PLUS A MACHINE CODE FREEZER MONITOR WITH EVEN MORE POWER!!

EVEN MORE FEATURES INCLUDING 80 COLUMN DISPLAY AND 2 WAY SCROLLING:-

- Full M68000 Assembler/Disassembler
- Full screen editor
- Load/Save block
- Write String to memory
- Jump to specific address
- Show Ram as text
- Show frozen picture
- Play resident sample
- Show and edit all CPU registers and flag
- Calculator
- Help command
- Full search feature
- Unique Custom Chip Editor allows you to see and modify all chip registers - even write only registers
- Netopair
- Disk handling - show actual track, Disk Sync. pattern etc.
- Dynamic Breakpoint handling
- Show memory as HEX, ASCII, Assembler, Decimal
- Copper Assemble/Disassemble - now with suffix names

REMEMBER AT ALL TIMES YOU ARE INTERROGATING THE PROGRAM IN IT'S "FROZEN" STATE WITH ALL MEMORY AND REGISTERS INTACT - INVALUABLE FOR THE DE-BUGGER OR JUST THE INQUISITIVE!

WARNING 1988 COPYRIGHT ACT WARNING

Datel Electronics Ltd., neither condones nor authorises the use of it's products for the reproduction of copyright material.
The backup facilities of this product are designed to reproduce only software such as Public Domain material, the users own programs or software where permission to make backups has been clearly given.
It is illegal to make copies, even for your own use, of copyright material, without the express permission of the copyright owner, or the licensee thereof.

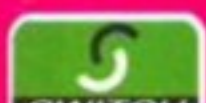

24 HOUR MAIL ORDER HOTLINE

0782 744707

ORDERS NORMALLY
DISPATCHED WITHIN 48 Hrs.



SEIKOSHA - QUALITY PRINTERS

24 PIN 240 CPS 80 COLUMN

NEW! COLOUR PRINTER



FREE!
STARTER KIT
WORTH £25
SEE ABOVE

ON-SITE WARRANTY OPTION
1 YEAR - ONLY £10.00 - POS 8515

- Seikosh SL-95 - 24 pin - 80 col
- 240cps SD, 192cps D, 64cps LQ
- 43K Printer Buffer + 9 Fonts
- Parallel Interface
- Graphics Resolution: 360 x 360 dpi
- Epson LQ860/850 Emulation - mono & colour
- Colour Printing as Standard (inc colour ribbon)
- Semi Auto Single Sheet Feeding as standard
- Second Ribbon Drive for Black Printing (Black Ribbon Optional Extra)
- Optional Automatic Cut Sheet Feeder
- 12 Month Repair Warranty
- FREE Silica Printer Starter Kit

PRINTER RRP £249.00
STARTER KIT £25.00
TOTAL VALUE: £274.00
SAVING: £85.00
SILICA PRICE: £189.00

£189

+VAT = £222.08 Ref: PRI 8305

AT AFFORDABLE PRICES

Silica Systems are pleased to recommend the high quality range of Seikosh printers. Built to the highest standards by a company that is used to manufacturing high quality precision products. Seikosh are part of the massive Seiko/Epson group with a turnover of £6 billion and 18,000 staff!

FREE! FROM SILICA

- **DELIVERY** Next day - anywhere in the UK mainland.
- **HELPLINE** Technical helpline during office hours.
- **STARTER KIT** With every Seikosh dot matrix printer



FREE!
FROM SILICA
WORTH
£29.38

Every Seikosh dot matrix printer from Silica comes with a FREE Starter Kit, worth £29.38 (£25.00 net). It includes all you need to get up and running with your new printer.

- 3 1/2" Disk with Amiga & ST Printer Drivers
- 1.8 Metre Parallel Printer Cable
- 200 Sheets of Quality Continuous Paper
- 100 Continuous Tractor Feed Address Labels
- 5 Continuous Envelopes on Tractor Feed

RETURN THE COUPON FOR YOUR FREE COPY OF SILICA'S
NEW SEIKOSHA CATALOGUE

9 PIN 192 CPS 80 COLUMN

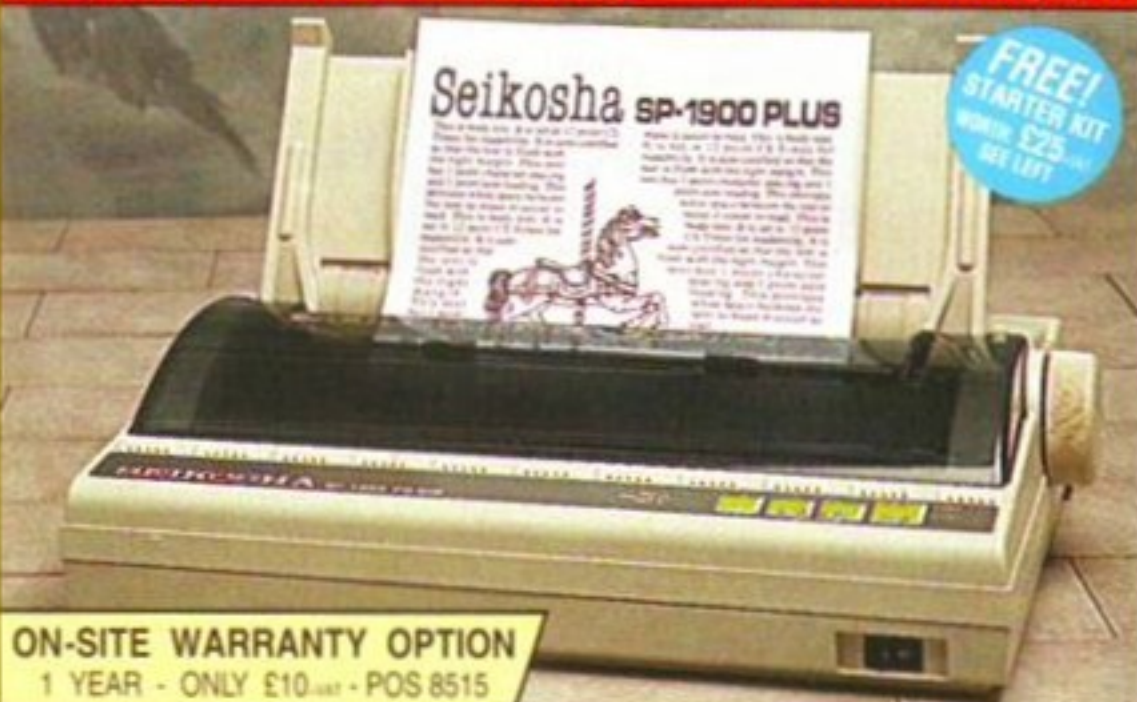

FREE!
STARTER KIT
WORTH £25
SEE LEFT

ON-SITE WARRANTY OPTION
1 YEAR - ONLY £10.00 - POS 8515

- Seikosh SP-1900 Plus 9 pin - 80 column
- 192cps Draft, 48cps NLQ
- 1K Printer Buffer + 2 Fonts
- Parallel Interface
- Graphics Resolution: 144 x 72dpi
- Epson and IBM Emulation
- Auto Sheet Feeder Option
- 12 Month Repair Warranty
- FREE Silica Printer Starter Kit

PRINTER RRP £155.00
STARTER KIT £25.00
TOTAL VALUE: £180.00
SAVING: £70.01
SILICA PRICE: £109.99

BEST BUY! £109.99

Ref: PRI 8195

+VAT = £129.23

24 PIN 240 CPS 80 COLUMN

- Seikosh SL-90 - 24 pin - 80 col
- 240cps SD, 192cps D, 84cps LQ
- 20K Buffer + 2 Fonts
- Optional Font ROM
- Parallel Interface
- Graphics Resolution: 360x360dpi
- Epson LQ850 Emulation
- Built-In Semi-Automatic Cut Sheet Feeder - Paper Parking Standard - Optional Automatic CSF
- 12 Month Repair Warranty
- FREE Silica Printer Starter Kit

FREE!
STARTER KIT
WORTH £25
SEE ABOVE



PRINTER RRP £199.00
STARTER KIT £25.00
TOTAL VALUE: £224.00
SAVING: £69.00
SILICA PRICE: £155.00

£155

ON-SITE WARRANTY OPTION
1 YEAR - ONLY £10.00 - POS 8515

9 PIN 300 CPS 80 COLUMN

- Seikosh SP-2400 - 9 pin - 80 col
- 300cps SD, 240cps D, 60cps NLQ
- 21K Printer Buffer + 5 Fonts
- Parallel and Serial Interfaces
- Graphics Resolution: 240x144dpi
- Epson and IBM Emulation
- Paper Parking Standard
- Optional Auto Sheet Feeder Unit
- 12 Month Repair Warranty
- FREE Silica Printer Starter Kit

FREE!
STARTER KIT
WORTH £25
SEE ABOVE



PRINTER RRP £185.00
STARTER KIT £25.00
TOTAL VALUE: £210.00
SAVING: £75.00
SILICA PRICE: £135.00

£135

ON-SITE WARRANTY OPTION
1 YEAR - ONLY £10.00 - POS 8515

24 PIN 216 CPS 136 COLUMN



FREE!
STARTER KIT
WORTH £25
SEE ABOVE

- Seikosh SL-130AI - 24 Pin - 136 Col
- 216cps Draft, 72cps LQ
- Parallel Interface - 16K Printer buffer - 8 Fonts
- Graphics Resolution: 360x360 dpi
- Epson and IBM Emulation
- Original + 3 Copies (max. thickness 0.3mm)
- Standard Auto Paper Load + Eject, Paper Parking and 1 inch Tear Off Facility - Optional Automatic CSF
- 12 Month Repair Warranty
- FREE Silica Printer Starter Kit

PRINTER RRP £525.00
STARTER KIT £25.00
TOTAL VALUE: £550.00
SAVING: £321.00
SILICA PRICE: £229.00

£229

SUPERB VALUE 24 PIN WIDE CARRIAGE PRINTER

LASER STARTER KIT NOW AVAILABLE

- PC PARALLEL CABLE 1.8m
- 250 SHEETS 110mm x 34 PAPER
- 100 LABELS
- 10 SHEETS SAMPLE LABELS
- 5 SAMPLE ENVELOPES
- SAMPLE COPIER PAPER

RRP £29.38

SILICA PRICE £14.69



INCLUDES 1 YEAR ON-SITE WARRANTY

4 PPM LASER 300 DPI

- OP-104 - 4 Pages per minute
- HP LaserJet III[™] Emulation
- Resolution: 300x300dpi - 14 Resident Fonts
- Uses Original HP[®] Font Cards
- Postscript Emulation Option (Extra)
- Optional IBM, Epson & Diablo Emulation Cartridges
- Centronics Parallel, RS232C/RS422 Serial I/Faces
- 512K RAM - expandable to 2.5Mb
- Flexible paper handling: Standard paper cassette - 100 sheets, Optional 2nd bin - 300 sheets
- Quiet Operation 46dB(A)
- Compact Design with Straight Paper Path
- Cable required: CAB 7500 for PC - £9.95 or CAB 7614 for ST/Amiga - £14.95

PRINTER RRP £899
TOTAL VALUE: £899
SAVING: £400
SILICA PRICE: £499

£499

POSTSCRIPT VERSION AVAILABLE
£899.00 + VAT = £1056.33

080193-1200

SILICA SYSTEMS OFFER YOU

- **FREE OVERNIGHT DELIVERY:** On all hardware orders shipped in the UK mainland.
- **TECHNICAL SUPPORT HELPLINE:** Team of technical experts at your service.
- **PRICE MATCH:** We normally match competitors on a "Same product - Same price" basis.
- **ESTABLISHED 14 YEARS:** Proven track record in professional computer sales.
- **£12 MILLION TURNOVER (with 60 staff):** Solid, reliable and profitable.
- **BUSINESS + EDUCATION + GOVERNMENT:** Volume discounts available 081-308 0888.
- **SHOWROOMS:** Demonstration and training facilities at our London & Sidcup branches.
- **THE FULL STOCK RANGE:** All of your requirements from one supplier.
- **FREE CATALOGUES:** Will be mailed to you with offers + software and peripheral details.
- **PAYMENT:** Major credit cards, cash, cheque or monthly terms.

Before you decide when to buy your new printer, we suggest you think very carefully about WHERE you buy it. Consider what it will be like a few months after you have made your purchase, when you may require additional peripherals and accessories, or help and advice. And, will the company you buy from contact you with details of new products? At Silica Systems, we ensure that you will have nothing to worry about. We have been established for almost 14 years and, with our unrivalled experience and expertise, we can now claim to meet our customers' requirements with an understanding which is second to none. But don't just take our word for it. Complete and return the coupon now for our latest FREE literature and begin to experience the "Silica Systems Service".

MAIL ORDER HOTLINE
081-309 1111

SILICA SYSTEMS

MAIL ORDER: 1-4 The Mews, Hatherley Rd, Sidcup, Kent, DA14 4DX Tel: 081-309 1111
Order Lines Open: Mon-Sat 9.00am-6.00pm No Late Night Opening Fax No: 081-308 0608

LONDON SHOP: 52 Tottenham Court Road, London, W1P 0BA Tel: 071-580 4000
Opening Hours: Mon-Sat 9.30am-6.00pm No Late Night Opening Fax No: 071-323 4737

LONDON SHOP: Selfridges (1st Floor), Oxford Street, London, W1A 1AB Tel: 071-629 1234
Opening Hours: Mon-Fri 9.30am-7.00pm (Sat close 6.30pm) Late Night: Thursday - 8pm Extension: 3914

SIDCUP SHOP: 1-4 The Mews, Hatherley Rd, Sidcup, Kent, DA14 4DX Tel: 081-302 8811
Opening Hours: Mon-Sat 9.00am-5.30pm Late Night: Friday - 7pm Fax No: 081-309 0017

ESSEX SHOP: Keddies (2nd Floor), High Street, Southend-on-Sea, Essex, SS1 1LA Tel: 0702 462426
Opening Hours: Mon-Fri 9.30am-5.30pm (Sat 9.00am-6.00pm) No Late Night Opening Fax No: 0702 462363

To: Silica Systems, AMFOR-0393-84, 1-4 The Mews, Hatherley Rd, Sidcup, Kent, DA14 4DX
PLEASE SEND A BROCHURE ON THE SEIKOSHA RANGE

Mr/Mrs/Miss/Ms: Initials: Surname:

Company Name (if applicable):

Address:

Postcode:

Tel (Home): Tel (Work):

Which computer(s), if any, do you own?

novatech

BLUEPRINT 1400 DUNDAS SPUR PORTSMOUTH PO3 5RW

DOT MATRIX PRINTERS

All Printers Include Free Amiga Cable

CITIZEN

		Ribbon
120D Plus	£111.63	£3.17
SWIFT 9	£170.38	£3.17
SWIFT 200	£186.83	£3.17
SWIFT 240	£239.70	£3.17
SWIFT 240 Colour	£251.45	£14.98

EPSON

LX400	£108.10	£3.35
LX100	£137.48	£5.82
LQ100	£171.55	£5.82
LQ570	£233.83	£3.58

NEC

P20	£198.58	£4.43
P30	£274.95	£4.43

PANASONIC

KX-P1170	£118.68	£4.05
KX-P2180 Mono	£151.58	£8.16
KX-P2180 Colour	£171.55	£16.45
KX-P1123	£151.58	£4.05
KX-P2123 Mono	£171.55	£8.16
KX-P2123 Colour	£203.28	£16.45
KX-P1124i	£203.28	£4.05

SEIKOSHA

SP-1900+	£108.10	£3.23
SL90 24 pin	£148.05	£POA
SL92 +	£198.58	£POA

STAR

LC20	£115.15	£2.76
LC100 COLOUR	£149.23	£11.45
LC24-100	£172.73	£3.40
LC200 COLOUR	£169.20	£11.45
LC24-20	£185.65	£3.40
LC24-200	£199.75	£3.40
LC24-200 COLOUR	£238.53	£13.22

INKJET PRINTERS

CANON

BJ10ex (Black or White)	£191.53
BJ10ex Sheet Feed (Black or White)	£51.70
BJ10ex Battery Pack	£41.13
BJ20 (Black or White)	£289.05
BJC800 Colour	£1523.98

CITIZEN PROJET

£339.58

HEWLETT PACKARD

DESKJET 500	£297.28
DESKJET 500 Colour	£372.48
DESKJET 550 Colour	£481.75
FX80 CART (500 Mono Only)	£61.10
256K RAM CART	£124.55
3YR ON-SITE MAINT.	£57.58

STAR

STAR SJ48	£190.35
SHEET FEEDER	£51.70
BATTERY PACK	£41.13

Ink Cartridges

	1+	6+	HEWLETT PACKARD	1+	6+
CANON			PAINTJET BLACK	24.68	22.33
BJ10E/BJ20	17.33	16.39	PAINTJET COLOUR	27.03	24.68
HEWLETT PACKARD			OLIVETTI JP350	17.33	16.39
DESKJET/500 INK CART	16.16	15.22	STAR SJ48	17.33	16.39
DESKJET LONG LIFE	22.03	21.09			
DESKJET 500 COLOUR	25.85	22.33			

MONITORS

PHILIPS CM8833/II £212

Including Free Lead+ Lotus Turbo Challenger II
12mths Onsite Maintenance
Please add £8.23 for Carriage

ORDER INFORMATION

Please Note Printer Carriage Charges

CARRIAGE CHARGES

UK MAINLAND NEXT WORKING DAY
Dot Matrix & Inkjet **£8.23**
Price is per Delivery **NOT** per Box
Call for non Mainland & Saturday
Ribbons & Ink Carts Post Free

TERMS & CONDITIONS

PLEASE READ CAREFULLY BEFORE ORDERING
PAYMENT MUST ACCOMPANY ORDER (CWO ONLY)
TELEPHONE CREDIT CARD ORDERS ARE NORMALLY
DESPATCHED SAME DAY. PLEASE ALLOW 5 WORKING
DAYS FOR CHECKS TO CLEAR BEFORE DESPATCH.
GOODS ARE NOT SUPPLIED ON A TRIAL BASIS. IT IS UP TO
YOU TO CHECK SPECIFICATIONS WITH MANUFACTURERS
BEFORE BUYING. WE DO NOT GUARANTEE COMPATIBILITY
PRICES & SPECS MAY CHANGE WITHOUT NOTICE. E.&O.E.



ALL PRICES INCLUDE VAT - JUST ADD CARRIAGE



TEL 0705 664144

Our review policy

Amiga Format has been voted 'magazine most influencing buying decisions' by dealers in trade magazine *Computer Trade Weekly* for three years running. That's because they know our reviews are the most trustworthy; what we say, you seem to agree with.

Simply enough, that's because a) we know what we're talking about, and b) we're honest. We know what you want, because we're Amiga enthusiasts ourselves. And because we're Amiga experts, we test everything to the full and see how it performs.

If something is let down by poor features, if it's difficult to use or if it's overpriced, we'll tell you. But on the other hand, if it's well worth the price, or does something amazing, we'll make you aware of the fact - and look out for the *Amiga Format* Gold award which distinguishes a truly excellent product, one that really stands out from the crowd.

How the Rating System works

SPEED (marked out of 5) ●●●●●

Tremendously important for both hardware and software: there's nothing more annoying than waiting. A purely intuitive judgement.

DOCUMENTATION (out of 5) ●●●●●

Although there are some packages that are so simple that no manual is needed, complex items benefit hugely from a good explanation.

ACCESSIBILITY (out of 5) ●●●●●

The target for all good software should be powerful but simple: this rating assesses how easy it is to get to grips with the item.

FEATURES (out of 5) ●●●●●

Does it do what you want it to do? How well does it do it? And does it also do lots of other things that you'd never have thought of?

VALUE (out of 5) ●●●●●

A pretty important rating, this one: if a package does everything you could wish for, it's no use to you unless you can afford to buy it.



The Verdict, our at-a-glance overall rating, is a percentage: it's based on sheer quality, but with price taken into account, so that you know what kind of a deal you get.

Let's get serious!

Here's the bit of the mag where we put the joysticks down for a while and join **Marcus Dyson** as he takes a look at some of the month's big 'serious' releases...



DTP ART EXPRESSION

If you're trying to create exciting logos, and smooth graphics for your desktop publishing documents, Soft Logik think they may have the answer to your problems. *Art Expression* is their newly released structured-drawing package, can it hope to be as good as their DTP program *PageStream*? More importantly can it hope to challenge Gold Disk's *Professional Draw*? **Page 138**

Music DREAM GMX-1

If you're making music with your Amiga, you'll want to use more than the internal sound chip for your sounds. You can of course use a sampler, or the costlier option of a Tone Module - more expensive that is, until now. Zone Distribution have a new sound module for about the same money you would expect to pay for a quality sampler. **Page 142**

DTP PAGESETTER 3

One thing that has always disappointed us about DTP programs on the Amiga, has been the poor screen display of coloured graphics. But now you can say goodbye to mono screen previews with the latest release of Gold Disk's *PageSetter*, which features a full 256-colour screen display on AGA chip set machines. *PageSetter 3* still represents the best-value Amiga DTP package to date, but is the new version any good? **Page 146**

Music CLARITY 16

Microdeal, king of the 8-bit Amiga samplers, aim to prove that 16-bit sampling isn't only the domain of the elite Fairlight and Synclavier bunch. But is this possible for under £150 on the Amiga? Are they talking hogwash? Read on... **Page 149**

Colour scanning POWER AND EPSON COLOUR SCANNERS

Whilst mono scanners for the Amiga are available in abundance, colour ones are less common. We take a look at a couple of new entries into the field. One is a handy hand-held and the other's a full-blown professional flatbed, both of them offer features previously unseen at their price point. **Page 154**

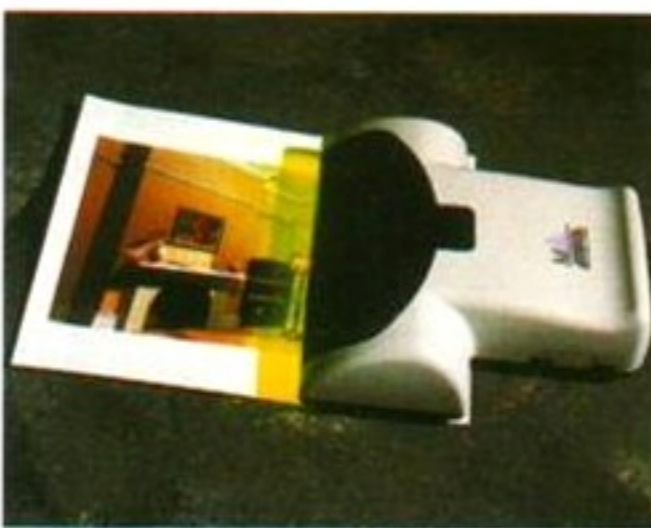

Word processing EXCELLENCE!

When the programmers of *Scribble!* (AF41 Coverdisk) wrote their excellent word processor, I doubt they imagined it would evolve into a full-blown word publisher, in the form of *Excellence!*. If you need to put pictures to your words, and print it all out in quality fashion, is this the program for you? **Page 158**



Education ADI

We take a look at three new education programs for 13/14-year-olds from Europress Software. Learn French, Maths and English the Adi way on... **Page 165**

Graphics DELUXE PAINT 4 AGA

Electronic Arts' *DeluxePaint* series of programs have always ruled the roost as far as paint packages for the basic Amiga machines are concerned. But since the A4000 and A1200 were launched, there have been no programs that take advantage of their new screen modes, until now that is. Check out if EA have managed to do it again on... **Page 132**



Graphics PERSONAL PAINT

This is another package designed to get the most from the new AGA chip set screen modes. While it can't manage the 262,000 colours of new HAM8 mode, it shines in 256 colours. There are also some surprising new and tasty image-processing modes hidden in there too. Read all about it on... **Page 136**



Electronic Arts' fourth incarnation of DPaint really comes of age.

Brian Larkman goes gaga for the AGA while trying out....



DeluxePaint AGA

Art Package ■ £99.99 ■ Electronic Arts

SO AT LAST it's here; the Amiga we've not been holding our breath for. The Amiga that puts the best graphical system back up there with the Macs and PCs. The Amiga with 256 standard, and 260,000 HAM colours and all this in up to 1472 x 566 overscan pixels. With all this power you've just got to have a decent paint program, and where better to look for it than Electronic Arts, the producers of the best standard paint program – *DeluxePaint*. True to form, EA have rushed out an upgrade that provides all of the new modes and resolutions and a few other tricks besides. But does it really USE the potential of this great system?

The major overhaul of *DPaint* took place last year with version IV supporting HAM – a development that Dan Silva, the 'inventor' of *DPaint*, resisted. That upheaval produced a sort of hybrid program that I have always found unsatisfying, and somehow incomplete. Now we know why – it needed the AGA!

Using *DPaint AGA* for the first time is a curious experience that everyone using newly AGAised software will feel, especially if it was a really well-loved package. It seems both familiar and foreign at the same time. All of the usual tools and palettes, requesters and gadgets are there but they seem smoother and more sophisticated. The reason? More colours at a higher resolution (due to the new chip-set rather than the program) plus a few subtle ideas from EA. For example, all named gadgets on requesters now have a letter underlined

DELUXEPAINT AGA is available from **Electronic Arts** 0753 549442

Over the years, Electronic Arts have used Pictures of King Tut to symbolise the power of *Deluxe Paint*. From Avril Harrison's first 32 colour version (still a classic), to the latest HAM8 'turning head' by Don Woo – the best features of the program are illustrated in the best possible way; by artwork produced with them!



as a keyboard equivalent, a trick betraying EA's Windows involvement. Neat though.

But painting, not gadgets and requesters, are what you will buy this set-up for, and it's here that the real transformation has taken place. More colours means that you are no longer stuck with only two or three decent smooth gradients, or re-arranging palettes in the middle of a drawing. Transparent objects

really look transparent and tints really give you the colours that you expect. Mind you, human nature being what it is, you will soon start expecting exactly the right shades, and even 256 colours will not be enough.

Never mind, a trip to the new Screen Format requester and you can acquire 250,000 extra colours with HAM8. Now every shade is perfect, though animation is – not surprisingly – just as slow as it was with standard HAM. Trouble is, now those low resolution pixels look huge and chunky. Time for another change of format, this time to 640 x 256 or even 1280 x 512 – every mode works with all those 256 or 260,000 colours. Amazing.

Of course, all of this is a product of the AGA chipset, not just EA's programming, so let's have a look at their contribution. Most of the new features are related to the AGA support or other new Amiga system functions. 24-bit IFF files can now be loaded, but not saved as the system only works in 8-bit internally. 8-bit and HAM8 anims and animbrushes are supported; at last, cut and paste to the Clipboard (and hence other programs) is provided; there is a new Player that supports the AGA; Appltems (Applcons and AppMenus) can be used – drop

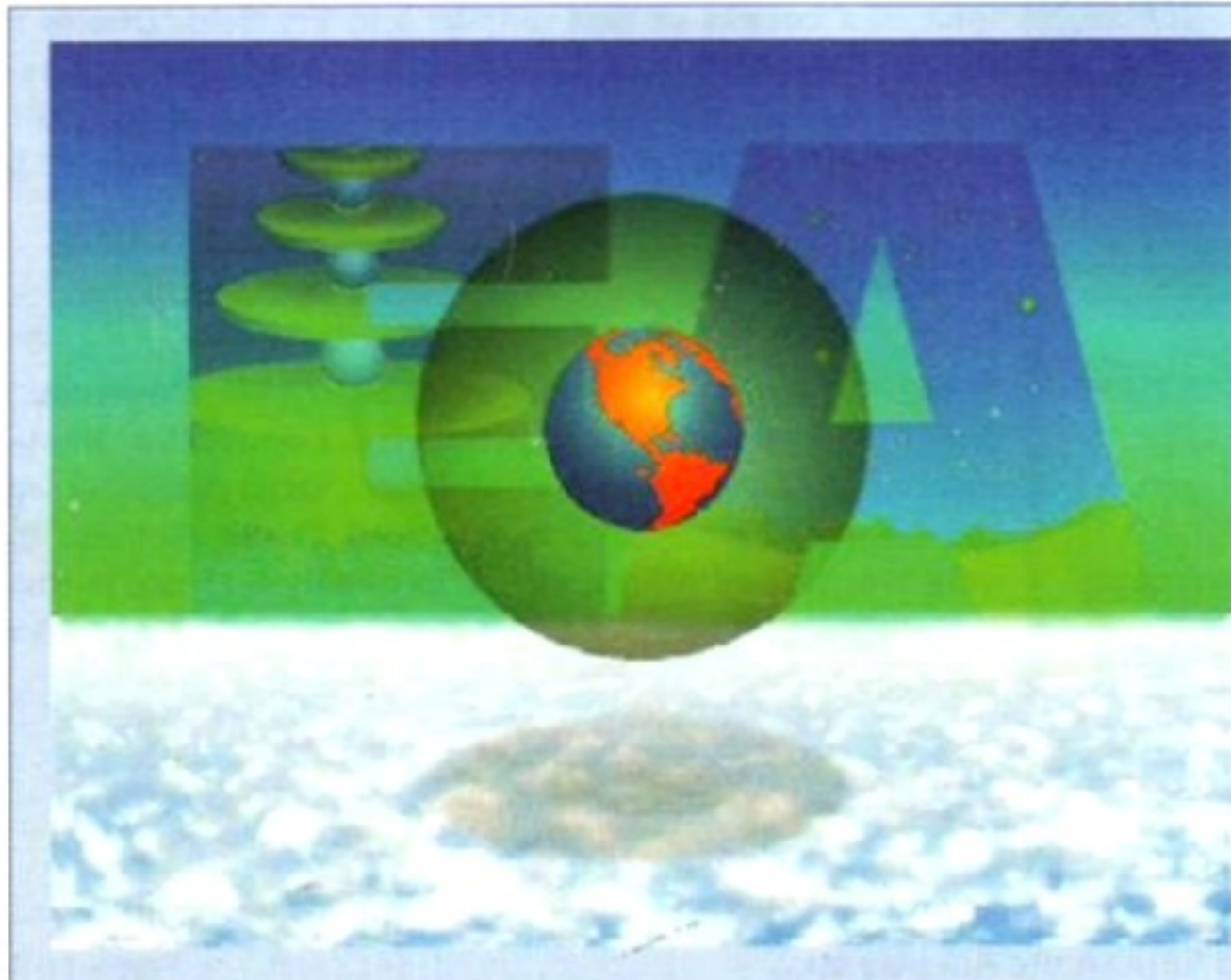

RUB THROUGH

The letters 'EA' here are a good example of the Rub Thru facility – the interior pictures were on a spare page and revealed by pasting the letter with Translucency and Lightbox both enabled. The 'atmosphere' is a gradient sphere with about 50 per cent translucency.

Notice the subtle range of colours – almost 24-bit quality! (A 640 x 512 screen only has 327,680 pixels in total. If 266,000 can be different and chosen from a 24-bit palette, there should be no difference from a true 24-bit display.

The only drawback for the majority of Amiga owners is that to create masterpieces like this with *DeluxePaint IV AGA*, you have to be in possession of an A1200 or 4000.

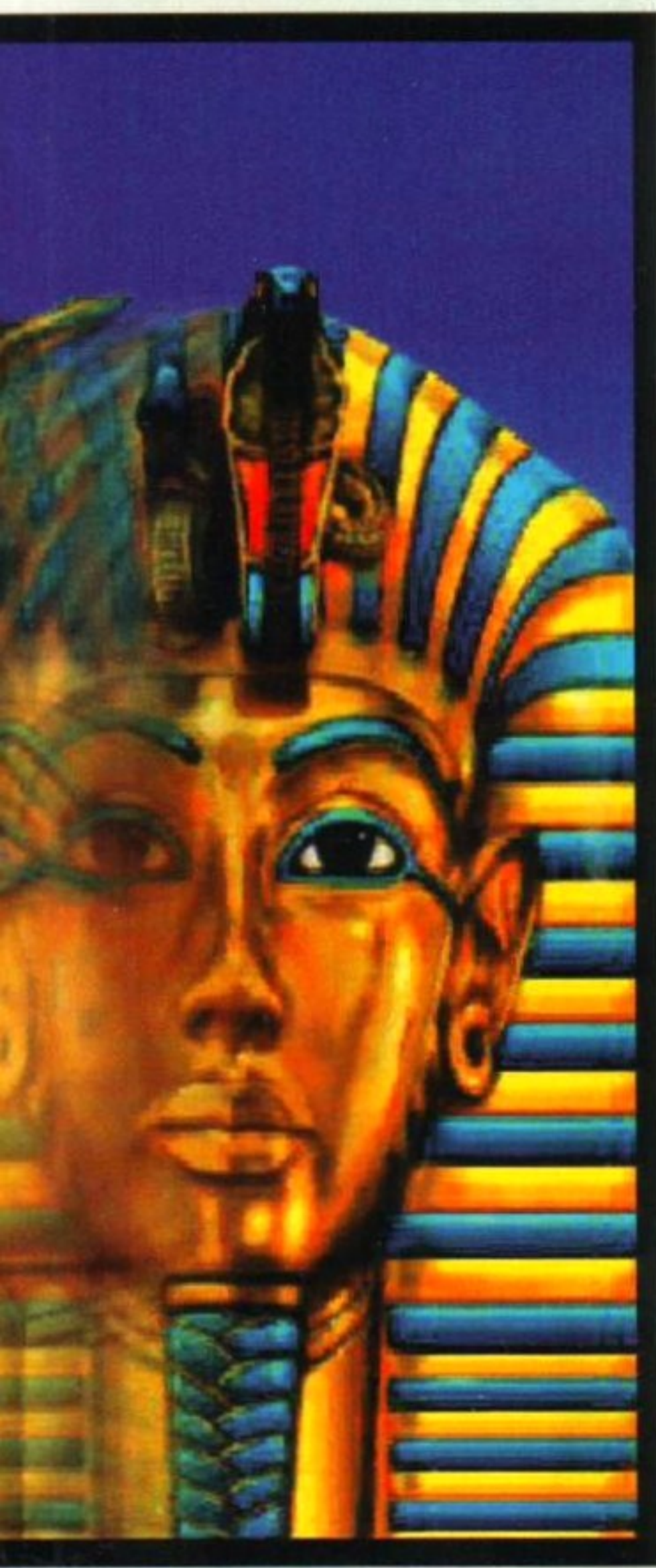

a picture icon on to the Applcon on the Workbench and it is loaded into the program and displayed; morphing can now be full screen (if memory allows) and in either direction. The best two features, however, are Rub Thru and support for pressure sensitive devices.

You've probably seen Rub Thru in *PhotonPaint*, *DigiPaint* or even *TVPaint*. The spare screen is used either blank or with an image and as you draw into it, instead of the chosen colour, the image on the main screen is revealed like the winning numbers on a newspaper's Bingo card. This can be an effective device, though *PhotonPaint* and *DigiPaint* do a better job because they have variable transparency tools and so the revealed image has soft edges. Used carefully, it can smoothly blend an object into a scene, but only with this softening. This is where *DPaint* sucks!

Even more exciting, though the cause of much future expense, is pressure-sensitive support. This is a real first for Electronics Arts. To the best of my knowledge, this is the first mainstream Amiga product that supports these miracles. The Calcomp Drawing Pad, like the Wacom Tablets used by OpalVision, is a straightforward cordless digitising tablet,

SO WHAT'S NEW?

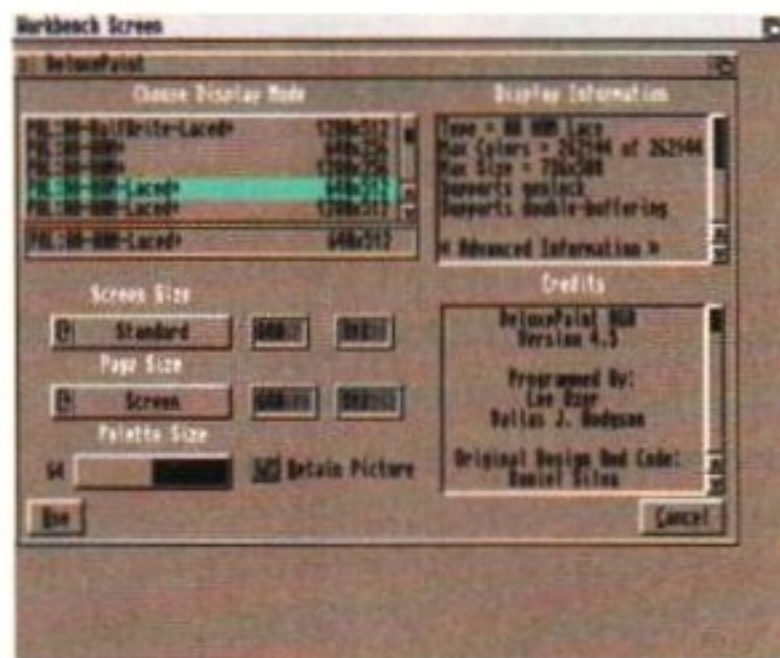

The complete range of available screen formats can be selected from this requester. The order can be confusing; pity it cannot be re-arranged by size, mode, or bit depth. All the extra info is very useful though.



Only 256 colours were used here at Productivity (VGA-640 x 480) resolution. For most drawings executed from scratch, standard mode - even with its more limited range of colours - can outweigh the slowness of HAM8 modes. Most artists are used to limited palettes, but want a fast, fluid drawing style.



Using the Dragons picture, this vase was drawn in about 20 minutes using a variety of gradients. With a good range of colours and a high resolution, the results are excellent. The huge palette now available shows off the

power of the various gradient fill types to much greater advantage than the old HAM palette.

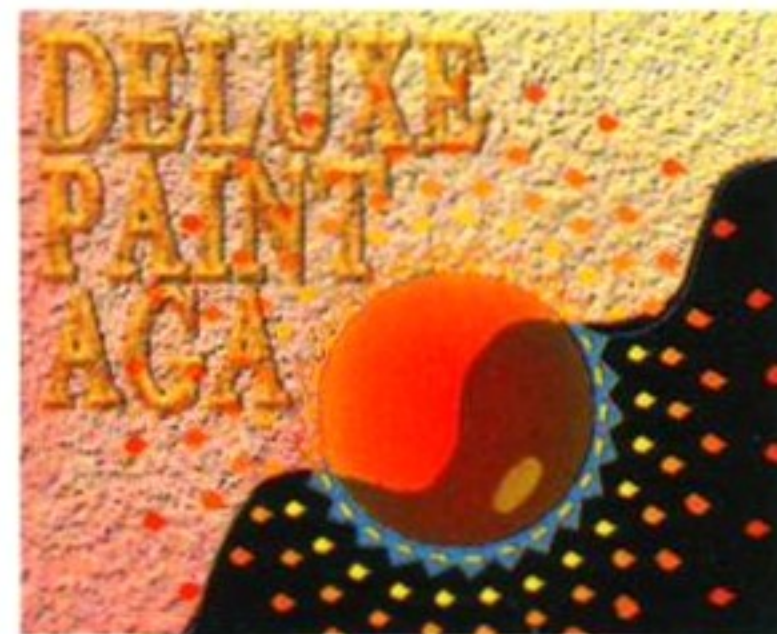

Translucency, gradient-fill and Rub Thru have been used here to produce an abstract composition with some subtle colour gradients that will probably not transfer to the printed page. Although the

Translucency and Rub Through features are very welcome, transparency in general does not have enough control. An Alpha channel, or feathered edges to brushes, or both, would be a great improvement.

but the tip of the stylus is pressure sensitive. As you draw, it senses the pressure you use and varies the weight of the mark - either the thickness of the line, the thickness of the paint or both - reproducing the variations of natural line drawing and painting almost perfectly.

The sensitivity achieved has to be experienced to be believed. How well it works with *DPaint* is uncertain because no driver software was available from Calcomp. As soon as we have tried it we will let you know how it feels.

So all in all, *Deluxe Paint AGA* is a pretty stunning package. But it must be realised that the AGA has only been out a few months. In time a lot more features should become available - either from Electronic Arts or from some other developer. Take the new system from Digital Creations - the makers of *DCTV*; it's called *Brilliance* and the features list of that really makes you sit up straight. *Deluxe Paint* has been the best for a long time, but it is beginning to show its age. And a number of quirks still haven't been fixed. (When are they going to let us paint under the toolbox menu?)

With the new power of AGA comes a new responsibility to provide tools that really use it. A few things that come to mind are a 'true' airbrush, more image processing (negative, emboss, blur, convolution, etc), fill and selection tolerance, representative icons with image size (like *Deluxe PHotoLab*), JPEG file compression, variable power Blend, Smear, Smooth, etc.

Most of all though, *DPaint* needs controllable transparency. This could be an alpha channel, variable width edge-feathering, or at least variable transparency like *PhotonPaint* - preferably all of them. Without this facility, 'true-colour' work is difficult; and *DPaint* will be left behind by new generation packages. But then I can't believe EA don't know this!

But for the price *DPaint* is still an amazing package. It allows true colour animation of astonishing power and flexibility, and a superb range of image manipulation tools, including some of the best perspective tools on any machine. Apart from *Personal Paint*, which has many weaknesses (see Page 136), *DPaint* is the only paint package to use the AGA and I couldn't do without it. It's a blast!

DeluxePaint AGA

SPEED

● ● ● ●
About the same as *DPIV* - the 020 balances the extra colours. An accelerator would help!

DOCUMENTATION

● ● ● ● ●
At the moment the good *DPIV* manual plus a Read-me - but that's all you need!

ACCESSIBILITY

● ● ● ● ●
It's what most of us learned on, so this is the standard.

FEATURES

● ● ● ● ●
Very broad, but not quite deep enough. Some tools need more variable control.

VALUE

● ● ● ● ●
A phenomenal program, and there's nothing on the market that can beat it. I want one!



90%

GASTEINER

Unit 2
Millmead Business Centre
Millmead Road
London N17 9QU
Tel: 081 365 1151
Fax: 081 885 1953



AMIGA COMPUTERS		HARD DRIVES		MICE + TRACKBALL	
A500+	£269.00	GASTEINER POWER		AlfaData	
A600	£269.00	• External IDE HDD for Amiga A500/A500+/A1500/A2000		Infra Red Mouse £45.00	
A600 20Mb Hard Drive	£465.00	• Memory conveniently expandable to 2/4/6/8Mb by using 1M X 4 Zips		Mega Mouse £10.95	
A600 60Mb Hard Drive	£549.00	• 100% compatible		Mega Mouse (Mat + Holder) £14.95	
A1200	£379.00	• Easy Installation, Just Plug in and go		300 Dpi Optical Mouse £27.95	
A1200 20Mb Hard Drive	£529.00	• Auto boot, Auto config and zero wait states		The Trackball £29.95	
A1200 40Mb Hard Drive	£599.00	Controller for A500/A500+/A1500/A2000	£99.00	Crystal Trackball £34.95	
A1200 65Mb Hard Drive	£639.00	Controller + 40Mb Hard Drive	£249.00	Optical Pen Mouse £35.95	
A1200 80Mb Hard Drive	£679.00	Controller + 65Mb Hard Drive	£279.00	Golden Image	
A1200 120Mb Hard Drive	£769.00	Controller + 85Mb Hard Drive	£299.00	GI-600	
A4000 120Mb Hard Drive	£2089.00	Controller + 120Mb Hard Drive	£329.00	Optical Mouse £13.95	
				Brush Mouse £19.95	
				New Golden Image	
				400 Dpi Mark 2 Mouse £14.95	
MONITORS		GASTEINER POWER FOR A600/A1200		SOFTWARE	
Philips CM8833 Mk2	£229.00	20Mb + IDE Cable	£149.95	Word Processors/publishing	
Commodore 1084/5 SDI	£209.00	65Mb + IDE Cable	£199.95	Pen Pal V1.4 £49.95	
Commodore 1960 Multisync	£439.00	85Mb + IDE Cable	£279.00	Final Copy II V2.0 £99.95	
Gasteiner Multisync Monitor	£349.00	120Mb + IDE Cable	£299.00	Kindwords 3 £39.95	
		Fitting For A600 or A1200	£29.95	Wordworth V1.1 £109.95	
				Transwrite £29.95	
PRINTERS		BARE HARD DRIVES		Prowrite 3.3 £79.95	
Citizen Swift 9 Colour	£179.00	IDE		Pagestream V2.2 £129.95	
Citizen Swift 240 Colour	£279.00	40Mb	£99.00	Professional Page V3.0 £129.95	
Citizen Swift 200 Colour	£219.00	65Mb	£199.00	Pagesetter II £44.95	
HP 500	£309.00	85Mb	£219.00	SoftClips Clip Art	
HP 500 Colour	£439.00	120Mb	£299.00	Classic Clip Art £29.95	
HP 550 Colour	£550.00	210Mb	£319.00	People Clip Art £29.95	
				Collectors Clip Art £29.95	
RAM		ACCESSORIES		Animal Clip Art £29.95	
A500 1/2Mb	£14.95	Power Supply A500/A500+/A600/A1200 (High Voltage)		Electric Thesaurus £29.95	
A500 1/2Mb With Clock	£19.95	Power Supply A1500/A2000		CAD & structured drawing	
A600 1Mb	£34.95	Internal Drive for A500		Intro CAD Plus £79.95	
A600 1Mb With Clock	£39.95	Internal Drive for A2000		X-CAD 3000 £269.95	
A1200 2Mb (PCMCIA)	£119.00	A500 Rom Switcher		Professional Draw 3 £89.95	
A1200 4Mb (PCMCIA)	£189.00	A600/A1200 Rom Switcher		Animation and Graphics	
1Mb Simms (Gvp)	£27.00	Auto sensing joystick/Mouse switch Box		Deluxe Paint 4 £64.95	
4Mb Simms (Gvp)	£89.00	Printer Cable		Real 3D Professional Turbo £249.95	
A2000 2Mb-8Mb	£129.00	Modem Cable		Art Department Professional V2 £144.95	
		SCSI Cable		DCTV Composite Video 24-Bit graphics System (PAL) £379.95	
		IDE cable for A600/A1200		Imagine 2.0 £189.95	
		External Drive for A2000			
		Blitz Amiga			
		ICD Flicker Free Video 2			
		Commodore 64 Power Supply			
		10 Blank Disks			
		3.5" External Drive			
SCANNERS					
Power Mono	£95.00				
Power Colour	£235.00				
AlfaData Mono	£99.00				
AlfaData Plus	£119.95				
AlfaData OCR	£165.00				
Gasteiner Mono	£89.00				
Gasteiner Scan Read	£129.00				
DataScan Pro V3	£89.00				
Epson GT 8000	£1199.00				



Products advertised represent a small sample of our instock range. A complete price list is available on request.

DELIVERY CHARGES:

Small consumables & software items
Other items, except lasers
Offshore and Highlands
IN ADDITION WE OFFER THE FOLLOWING EXPRESS SERVICES:
Saturday deliveries
AM next day

UK MAINLAND (NOT HIGHLANDS)

Despatched by post, please check charges when ordering
Next day courier service, £10 per box
Please enquire
Normal rate plus £15+ VAT per box
Normal rate plus £8+ VAT per box

E & OE. Price subject to change without notice. Goods subject to availability, specifications subject to change without notice. All Trademarks Acknowledged.



POST HASTE

ALL PRICES INCLUDE VAT & DELIVERY TO YOUR DOOR

Select any 3 titles valued £7.99 or less and you pay only £20

SOFTWARE

Some of the following games titles are limited offers at the time of going to press. Order early to avoid disappointment. We stock all the latest and currently available titles which we offer at **30% OFF** Recommended Retail Prices

GAMES

1st Division Manager	6.99
4D Sports Driving	7.99
4 Wheel Drive Compilation	9.99
Afterburner	6.99
Allen Breed 92	8.99
Armalyte	7.99
Awesome (Psygnosis)	7.99
Bard's Tale III	7.99
Batman the Movie	6.99
Battlehawks 1942	10.99
Battle Squadron	7.99
Battlechess	7.99
Betrayal	6.99
Bubble Bobble	6.99
Budokan	8.99
Captain Dynamo	6.99
Captain Fizz (Psygnosis)	6.99
Captive	7.99
Carrier Command	7.99
Centurion Defender of Rome	7.99
Champions Compilation	9.99
Chase HQ	6.99
Chuck Rock	9.99
Classic 4	6.99
Colossus Chess X	6.99
Conqueror	6.99
Corporation - Missions	9.99
Deluxe Strip Poker 2	9.99
Dizzy Panic	6.99
Double Dragon II	7.99
F16 Combat Pilot	8.99
Falcon	9.99
Fantasy World Dizzy	6.99
Final Blow	7.99
Flight of the Intruder	10.99
Flimbo's Quest	7.99
Football Crazy Compilation	12.99
Future Wars	9.99
Gem X	6.99
Ghouls 'n' Ghosts	6.99
Golden Axe	7.99
Harlequin	7.99
Head Over Heels	6.99
Impassable	6.99
Indy Heat	7.99
Indy Jones - Last Crusade Action	6.99
Indy Jones - Last Crusade Gr. Adv	10.99
International Karate -	6.99
Jack Nicklaus Golf	6.99
James Pond	6.99
Jet Set Willy II	7.99
Keef The Thief	7.99
KickOff 2 Europe data	6.99
KickOff 2 Giants of Europe data	6.99
KickOff 2 Winning Tactics data	6.99
Killing Game Show (Psygnosis)	7.99
Kwik Snax	6.99

4 Wheel Drive

Lotus Turbo Challenge
Toyota Celic GT Rally
Combo Racer
Team Suzuki
Only £9.99

Last Ninja 3	7.99
Line of Fire	7.99
Lombard RAC Rally	6.99
Lotus Esprit Turbo Challenge	7.99
Magic Garden	7.99
Magician Dizzy	6.99
Manchester United	7.99
Manic Miner	7.99
Megafortress	9.99
Megalomania	7.99
Midnight Resistance	6.99
Midwinter	9.99
Moonstone	9.99
Navy Seals	7.99
New Zealand Story	6.99
Ninja Warriors	7.99
North & South	6.99
Obituary (Psygnosis)	7.99

SUPER SEGA

Golden Axe
Super Monaco G.P.
Shinobi
Crack Down
Eswat
Only £9.99

Operation Thunderbolt	6.99
Pacland	7.99
Pacmania	7.99
Pang	6.99
Paperboy	6.99
Populous	8.99
Populous Promised Lands	4.99
PP Hammer	6.99
Prince of Persia	6.99
Pro Tennis Tour	6.99
R-Type	6.99
RBI Baseball	7.99
Rainbow Islands	6.99
Rick Dangerous	6.99
Rick Dangerous 2	7.99
Robocop	6.99
Rodland	7.99
Rugby World Cup	7.99
Shadow Dancer	7.99
Shadow Warriors	6.99
Shoot'em Up Construction Kit	7.99
Slightly Magic	6.99
Sly Spy	6.99
Spellbound Dizzy	6.99
Spike in Transylvania	6.99
Spirit of Excalibur	9.99
Stunt Car Racer	6.99
Supercars 2	7.99
Super Monaco GP	7.99
Super Sega	9.99
Super Seymour to Hollywood	6.99
Super Smash TV	6.99
Swiv	7.99
Test Drive II	6.99
Tie Break (Tennis)	7.99
Total Recall	6.99
Toyota Celica GT Rally	6.99
Treasure Island Dizzy	4.99
Trivial Pursuit	6.99
Turbo Outrun	6.99
Turrican	6.99
Turrican II	7.99
Turtles 2 The Coin Op	9.99
Untouchables	6.99
Video Kid	7.99
Viz	7.99
Winning 5 Compilation	7.99
World Championship Soccer	7.99
World Cricket	6.99
World Soccer Italia 90	7.99
Z-Out	6.99
Zak McKracken	9.99

BE AMONG THE FIRST TO PLAY!!! PRE-BOOKED SOFTWARE

We accept advanced orders for all forthcoming software titles and your order will be despatched on the day of release. Your credit card will be debited also on the same day as despatch!

EDUCATIONAL

ADI English (11/12 or 12/13)	16.99
ADI English (13/14 or 14/15)	16.99
ADI French (11/12 or 12/13)	16.99
ADI French (13/14 or 14/15)	16.99
ADI Maths (11/12 or 12/13)	16.99
ADI Maths (13/14 or 14/15)	16.99
Answerback Junior	14.49
Answerback Senior	13.99
Arithmetic (Answerback data)	7.49
Spelling (Answerback data)	7.49
Better Maths (12-16)	16.49
Better Spelling (over 8)	16.49
Cave Maze	10.99
Count and Add	16.99
First Letters	6.99
Fraction Goblins	10.99
Fun School 2 (2-6, 6-8, or 8+)	7.99
Fun School 3 (2-5, 5-7, or 7+)	16.99
Fun School 4 (2-5, 5-7, or 7+)	16.99
Henriettas Book of Spells	16.99
Hooray for Henrietta	16.99
Kids Academy Which Where What	14.99
Kids Academy Shopping Basket	14.99
Kids Academy Alvin's Puzzle	14.99

Compendium SIX

Kids Type
Weather Watcher
What is it Where is it?
Calendar Quiz
Words & Numbers
Game, Set & Match
Only £29.99

Lets Spell at Home	13.99
Lets Spell at the Shops	13.99
Lets Spell Out and About	13.99
Magic Maths (4-8)	16.49
Maths Adventure	16.99
Maths Dragons	10.99
Maths Mania (over 8)	16.49
Mega Maths	17.99
Merlin Maths	16.99
Mickeys Crossword Puzzle	17.49
Micro English	17.99
Micro French	17.99
Micro German	17.99
Micro Maths	17.99
Micro Science	17.99
Mix & Match	16.99
Noddy's Playtime	16.99
Paint and Create	16.99
Paint Me a Story	16.49
Picture Fractions	10.99
Reasoning With Trolls	10.99
Shapes and Colours	6.99
Sooty's fun with numbers	13.99
Spellbook	7.99
Spelling Fair	16.99
Telling The Time	10.99
Things to do with Numbers	13.99
Things to do with Words	13.99
Thomas Tank fun with words	13.99
Three Bears	16.49
Tidy The House	10.99
World Atlas	44.99
Voyager (Astronomy)	59.99

SERIOUS

VIDEO & MULTIMEDIA

Photon Video (Cel Animator)	7.99
Deluxe Video III	59.99
Broadcast Titrer 2	174.99
Broadcast Titrer Font Pack	99.99
Broadcast Titrer Font Maker	99.99
AmigaVision	99.99
Hyperbook	49.99
Scala	174.99
Scala 500	74.99
Director II	79.99
TV Text Professional	89.99
TV Show 2	89.99
Videotitrer 1.5 3D	69.99

WORDPROCESSING

Final Copy	39.99
Final Copy II	59.99
Penpal	34.99
Excellence 3	54.99
Protext 4.2	39.99
Protext 5.5	99.99
Word Perfect 4.1	159.99
Wordworth 2	89.99

SPREADSHEET

ProCalc	99.99
Advantage	79.99
DG Calc	28.99

DATABASES

Infotile	19.99
Superbase Personal 2	29.99
Superbase Professional 4	199.99

INTEGRATED (WP/SS/DB)

Mini Office	37.99
The Works Platinum	59.99
Gold Disk Office	49.99
DTP	49.99
Pagesetter 3	129.99
PageStream	199.99
Pro Page 3.2	99.99
Pro Draw 2	99.99
Outline Fonts	99.99
Gold Disk Fonts 1-4	34.99
Structured Clip art	39.99
Deluxe Print II	19.99
Eclips	79.99
Proclips	17.99
Pro Vector	159.99
Designworks	79.99
Expert Draw	39.99

CAD

X-CAD 3D	299.99
X-CAD Professional	149.99

ACCOUNTS

Arena Accounts	79.99
Home Accounts 2	39.99
Cashbook/Final Accounts	44.99

PERSONAL TAX PLANNER

Personal Finance Manager - 29.99
GRAPHICS 27.99

Deluxe Paint IV	59.99
Deluxe PhotoLab	34.99
Spectracolor	57.99
Disney Animation Studio	74.99
Real Things Birds	20.49
Real Things Dogs	20.49
Real Things Humans	20.49
Real Things Horses	20.49
Real Things Sea Life	20.49
Real Things Safari	20.49
Profills	24.99
Turboprint Professional	34.99
The Art Department	49.99
The Art Department Pro 2.00	134.99
Morph Plus	139.99
Kara Anim Fonts 1, 2 or 3	29.99
Kara Fonts Headlines 1 or 2	49.99
Kara Fonts Sub Headlines	44.99

3D MODELLING & RENDERING

3D Construction Kit	32.99
4D-Professional	199.99
Expert Draw 4D Jnr	47.99
Sculpt 3DXL	84.99
Sculpt Animate 4D	199.99
Vista Professional	69.99
Scenery Generator	32.99
Scenery Animator	59.99
Imagine 2	149.99
3D Professional	349.99
Real 3D Beginners 1.4	119.99
Real 3D Professional/Turbo 1.4	299.99

PROGRAMMING

Amiga Logo	19.99
Easy AMOS	22.99
AMOS Compiler	20.49
AMOS 3D	23.49
AMOS Professional	44.99
Devpac 3	49.99
Hisoft Basic	57.99
Hisoft Basic Extend	14.49
Hisoft Pascal	74.99
GFA Basic 3.5	7.99

MUSIC

Music Mouse	9.99
Stereo Master	29.99
Deluxe Music Const. Set	49.99
MidiMaster Midi I/F	19.99
AudioEngineer SoundSampler 2	169.99
TechnoSound Turbo Sampler	29.99
Bars & Pipes Professional	99.99
Bars & Pipes Int. Sound Kit	49.99
Bars & Pipes Music Box A	49.99
Bars & Pipes Music Box B	49.99
SuperJam	74.99

MISCELLANEOUS

AREXX	32.99
BAD Disk Optimiser	34.99
Cross Dos 5	29.99
Dos 2 Dos	39.99
Disk Master II	44.99
FloppyDisk Accelerator Faccll	9.99
GB Route Plus (New Version)	34.99
Icon Paint	8.99
Quarterback 5 H/DiskBackup	42.99
Quarterback Tools	59.99

HARDWARE

A500 Plus Cartoon Classics	299
A600	299
A600 Wild Weird & Wicked Pack	329
A600HD Epic Pack	379
A1200	379
A1500 Including Monitor	649
A1500 No Monitor	449
A4000	2099
CDTV	379
10% OFF all CDTV software	

OPALVISION

Superb 24 bit Graphics Card
With future addons such
as Framegrabber/Genlock
Roaster Chip and Scan
Rate Converter
Only £699

A2000a 20Mb Hard Disk for A1500	99
GVP A500 80Mb-8MbRAM(0k)	429
GVP A500 120Mb-8MbRAM(0k)	479
GVP SCSI Controller-8Mb(0k)	119
GVP SCSI 80Mb-8MbRAM(0k)	369
GVP SCSI 120Mb-8MbRAM(0k)	429
80Mb for A600/A1200	279
120Mb Maxtor bare hard drive	350
45Mb to 520Mb Bare hard disks	POA
44Mb Syquest Removable H/Disk	299
Cumana 3.5" External Drive	55
Zydec 3.5" External Drive	49
A500 3.5" Internal Drive	45
A600 1Mb Upgrade	38
A500 Plus 1Mb upgrade	35
A500 512k Ram Upgrade(no clock)	20
A500 512k Ram Expansion-clock	25
1.5 Mb Ram Expansion	79
Supra 500RX 8Mb RAM (2Mb Pop)	129
Supra 500RX 8Mb RAM (4Mb Pop)	219
Supra 500RX 8Mb RAM (8Mb Pop)	339
GVP A2000/1500 8Mb Ramcard (0k)	89
1 Mbyte Simms	25
256kx4 RAM chips per Mb	35
1Mb x1 DRAM chips per Mb	35
A2620 Accelerator Card	199
AT-Once PC 286 Emulator	229
Rombo Vidi 12 Pack	89
OpalVision 24bit Graphics	699
Sharp JX100 A6 Col. Scanner	499
Zydec Hand Scanner	99
Power Scanner	99
Genitler Graphics Tablet	129
Zydec Microswitched Mouse	17
Naksha Mouse-Operation Stealth	23
Itsa Mouse (Microswitched)	12
Mouse Mat	3
50 Blank Disks	25
MONITORS	
Phillips 9833-II (UK Model)	219
Commodore 1084/1085s	199
Commodore 1060 Multisync	499
PRINTERS	
(Inc. leads-Amiga Printer Drivers)	
Star LC200 Colour	199
Star LC24-20 Mono	199
Star LC24-200 Colour	269
Starscript Postscript Laser	1099
Citizen Swift 9 Colour	179
Citizen Swift 240 Colour	299
Citizen Swift 200 Colour	229
Canon Bubblejet Portable	219
HP Deskjet 550C Colour	529

TOP TITLES SPECIALS

Putty, Lotus 3, Zool, Wizkid, Aquatic Games, Troddlers, Catch'em, Fireforce, Assassins, WWF 2, Project X, John Madden's Football, Sensible Soccer 92/93, Fire&Ice, Jaguar XJ220, Pinball Dreams, Pushover, Road Rash, Archer Macleans Pool, Premier Manager, Humans, Nigel Mansell Grand Prix,**£18.99 EACH**

Shadow of the Beast 3, Street Fighter 2, Populous II, Dynablasters, Ishar, Lure of the Temptress, Castles, Premiere, Dungeon Master & Chaos Strikes Back, Pinball Fantasies, Reach For The Skies, Dreadnoughts, Lemmings Double Pack, Shuttle, Legend of Kyrandia,**£18.99 EACH**

Indiana Jones and the Fate of Atlantis, Civilisation, Knights of the Sky, Silent Service II, Microprose Grand Prix, A320 Airbus, Eye of Beholder II, Campaign, Links Golf, Curse of Enchantia, Nick Faldo Golf, Gunship 2000, Chaos Engine, History Lines 1914-1918, Sim Earth,**£22.99 EACH**

Monkey Island 2, Perfect General.....**£23.99 EACH**

You name it... We do it... Just phone and we'll quote... We are faster and cheaper!

PRICES QUOTED ARE SUBJECT TO AVAILABILITY.. SOME OFFERS ARE LIMITED SO ORDER EARLY TO AVOID DISAPPOINTMENT

Cheques/PO Orders to **POST HASTE**, 11a Burgate Lane, Canterbury, Kent. CT1 2HH

TELEPHONE HOTLINE 0227-764204 9.30am to 7.00pm

(Answerphone outside normal hours)

VISA, MASTERCARD and EUROCARD orders welcome

Visa, Mastercard, Eurocard and PO Orders are despatched same day!

Please allow up to 4 working days for cheques to clear. Overseas orders add £2.00 postage.

MAIL & TELEPHONE ORDERS ONLY... NO PERSONAL CALLERS PLEASE!



Stop shooting in the dark. At last there's an image-processing program with a proper visual interface. **Brian Larkman** discovers the hidden depths of...

Personal Paint

AGA Paint & Image Processing Package
 ■ £59.99 ■ Cloanto

AMIGA FORMAT

DON'T BE DECEIVED by first impressions. To begin with *Personal Paint* looks like a mediocre *DeluxePaint* clone (and closer to version II than IV). No perspective, no animation and no HAM (8 or otherwise). But once you delve into the program, you realise this is more of an image-processing program with paint tools than a paint program with image processing. And thankfully, someone has at last come up with a program where you can look at the image, not a screen full of boring 3D buttons and 'fuel gauges'.

The developers of first-generation image processing systems are easy meat to criticise though. They had a limited set of standard modes to work with, and a very slow processor as a base machine. As a result you have three choices, working blind with 24-bit images that you cannot display properly in *Art Department Professional* or *ImageMaster*; fighting the fringes by using *Photon Paint*'s colour modes; or juggling palettes trying to get the limited Smear, Blend and Smooth tools of *DPaint* to work as you want.

Now, though, one of the joys of the new second generation AGA Amiga graphics is that 256 shades can display very close to 'true' colour – which means proper image-manipulation tools. You can now process realistic images quickly on-screen, using standard Amiga display modes. *Personal Paint* is hopefully just the first of many that do just that. So what are the tricks on offer?

Let's start at the weak end of the spectrum

PERSONAL PAINT is available from **Micro-PACE** 0753 551888.

The combination of Watercolour and Raised effects produces an oil-paint and palette knife effect for the main rider. Embossing the background produces the 'carved from the stone' look.



– the paint tools. All of the usual ones are there: free hand, curved and straight lines, circle, rectangle, ellipse and irregular polygons, filled and outline – airbrush, fill, text, grid, magnify – gradients, stencil, all operating more or less like *DPaint*. The trouble is they are missing the user-definable parameters and painting tricks that make *DPaint* so unique. True, *Personal Paint* has some interesting tricks of its own, like four-point curves and proper contour fill, but the lack of fine tuning marks it down as a full paint program.

Image-processing, though, is where *Personal Paint* shines. It's features here prove what its real role is – to break the mould of Amiga paint programs.

Processing can be applied in one of three ways: to the whole screen, to a brush or to a selected area of the screen (via a special toolbox icon). A Processing Filter requester enables a wide range of pre-defined filters to be selected from a list. Many of these are illustrated opposite. Each one of the named filters can be edited to fine-tune it or to make a completely new process, which can be added to the list. The methods provided include Convolution with Division Factor and Bias, Popularity, Random, Dispersed, Clustered and Floyd-Steinberg filters. When you think of the combinations that these can provide, then you have an almost infinite variety.

As well as the convolution tools it is possible to adjust the overall palette for R,G and B brightness, saturation and contrast, though not Gamma. Statistics, reduce colours, and various remapping and palette manipulation features complete the line-up.

Two other sets of features mark out *Personal Paint* as a processing, rather than painting system – PostScript printing support

IMAGE PROCESSING

Butcher and *Pixmate* brought image processing to the Amiga early on in its life. Though they experienced their 15 minutes of fame at the time, they soon faded from sight, mainly because 16 or 32 colours is just not enough to do much with.

The real excitement started when 24-bit frame buffers began to become available. First *The Art Department*, then *Art Department Professional* from ASDG and *ImageMaster* from BlackBelt brought quality processing to the average user. Meanwhile, *PhotoShop* on the Apple Macintosh walked away with all the honours for its easy visual interface, virtual memory, zoomed-out editing and 'plug-in' modules. *Personal Paint*, with its visual style, has the potential to emulate some of *PhotoShop*'s ease of use, and if it could use *ADPro*'s modules, it could emulate most of its power too. We live in hope!



Personal Paint is not just a paint package, it has image-processing facilities too.



and the range of file formats handled. There is too little room here to go into detail, but both are pretty good. Finally a pet love of mine: it is possible now to save representative icons so you can see on the Workbench what the picture is. Brilliant.

So, overall *Personal Paint* makes a good stab at being an image processor – nowhere near as powerful as *ADPro* or *ImageMaster* but much easier to use, and this is only version 1! What can we expect/hope to see in version 2?

One of the most important functions of a processing system is merging images together – inserting Woody Allen into Hitler's photo-opportunity with no sign of a join. At the very least you need to blend and smear the edge pixels of the pasted brush, something *DPaint* does quite well.

In *Personal Paint* there is no way to get brushes to interact with the main painting surface at all, other than just pasting them down. Here some form of variable transparency is sorely needed, at least at the edges. *DPaint* is also a little weak in this area, but seems like a Quantel Paintbox in comparison. Ideally variable translucency, an Alpha channel and feathered edges are what's needed.



NEGATIVE
Especially useful if you want to scan a colour negative rather than a positive slide.



WATERCOLOUR
Not quite a proper watercolour effect, but it does look hand painted. Even better with 'Rised' effect shown in the box at bottom left.



DARK GRADIENT, TINT, LIGHTEN
Obvious really, but all these functions are controllable by percentage and as a gradient in eight directions.



SHARP/BLUR
Convolution Filters are especially good at blurring and sharpening detail.



DEEP EMBOSS
This has relief-type effect is produced by the Emboss function. The effect is nice, if a little limited in its applications.

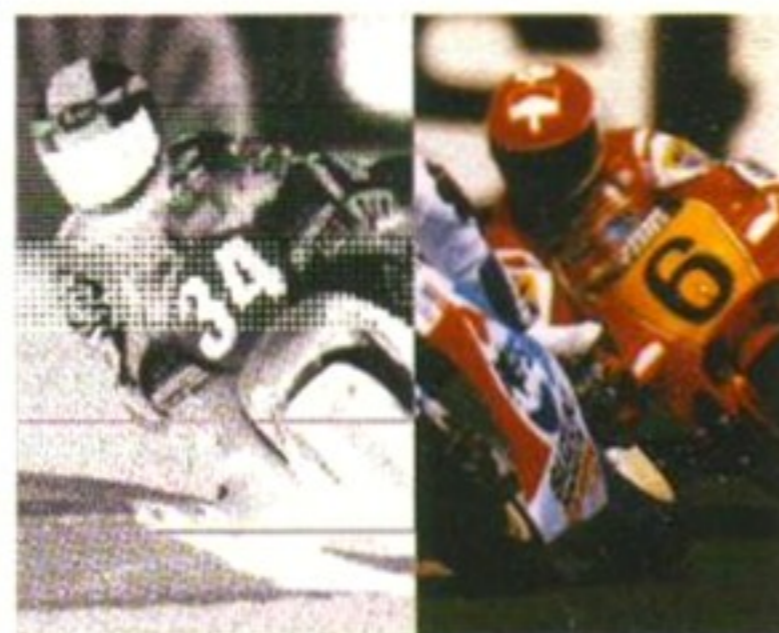

1-BIT DITHERING
For use in printing, (half-tone and patterned dithering) these are of use on large pictures that will be printed at 300dpi or greater. Two colour bitmaps like these can also be used as stencils.



The interesting effect displayed on the left of this picture is created by the randomise function.

GIF, PCX, C and CRYPT are all very well as file formats for PC use, but for the Amiga, HAM-E, DCTV and several other formats are required, plus PICT, TIFF, TGA, Rendition and others for full compatibility – and JPEG is now essential. An easy way round this would be to make *Personal Paint* compatible with ASDG's Loaders, Savers and perhaps even Operators. This happens widely in the Apple Macintosh world where many programs support *PhotoShop* (which is a Macintosh image-processing program) 'plugins'. To operate effectively though, *Personal Paint* would have to operate in 24-bits internally and support 8-bit HAM. Is this asking too much?

Unlike conventional painting, which provides an almost infinite range of textures, shades of colour and effects, the computer artist is limited by the imagination and ingenuity of the program's tools. It's exciting, then, for a computer artist to come across a new program, and a new set of tricks.

Personal Paint is not *DeluxePaint* by any means; instead it has its own set of surprises, greatly enhanced by use of the AGA. The challenge of the second generation machines is to the established developers. Will they just upgrade their software to display the 'near-true' colours, or will they provide effective new tools to really use these new modes? Although limited as a paint program, *Personal Paint* shows the way to the producers of the current favourites in both paint and image-processing software. 

Personal Paint

SPEED

Image processing is very processor intensive, but generally it moves well. ●●●●

DOCUMENTATION

The manual has a reasonable reference section and some tutorial help. ●●●

ACCESSIBILITY

Has a standard *DeluxePaint* interface, and processing while you wait. ●●●●

FEATURES

Good image processing and printing – but weak painting. ●●●●

VALUE

Expensive for a paint program, but cheap considering the image processing functions. ●●●●



79%

Could Professional Draw's dominance of the structured-drawing market be coming to an end? **Jason Holborn** looks at the latest contender from Soft-Logic...

Art Expression

Structured drawing ■ £169.95 ■ Soft-Logic

FOR MANY YEARS, Gold Disk have dominated the desktop publishing structured-drawing market. Now, though, their monopoly is under threat from Soft-Logic – the developers of *Professional Page's* rival, *PageStream*. Their new *Art Expression* program is for DTP users who need to include high-resolution, jaggie-free illustrations in their documents.

Like Gold Disk's *ProDraw* (AF39, 92 per cent) this is a structured-drawing program designed specifically for the production of illustrations and artwork for DTP. Unlike a bitmap-based paint program like *DPaint*, *Art Expression* images are not held as a series of coloured pixels. Instead, its illustrations could better be compared to a CAD system, where each line, curve and point is held as a series of coordinates, with complex illustrations being made up from these three basic primitives.

Structured-drawing programs enable Amiga DTPers to produce illustrations that can be printed at the highest resolution of your printer. If you have access to a professional imagesetter, then this means over 2,400dpi images – that's like having almost six million pixels for every square inch of print out!

Like its page-layout system, *PageStream*, Soft-Logic's latest product boasts a full Workbench 2.0-compatible user interface. *Art Expression's* main screen comprises two windows, one of which is your work page, the other is used to construct your structured

ART EXPRESSION is available from Silica Systems on 081-309 1111

Art Expression is capable of loading and displaying illustrations in a variety of different formats, including EPS – these can be displayed in full colour.



images. The second window is a *PageStream*-like toolbox, this has a selection of commonly used drawing tools, including straight lines, bezier curves, boxes, circles and the obligatory freehand drawing mode that converts your scribble into a series of bezier curves.

The quality of these basic editing tools is very good, and it's surprisingly simple to get very respectable results. *ProDraw's* editing tools are sometimes a little unresponsive, but

Art Expression's are more precise. That said, problems do occasionally crop up – when constructing a line from a series of bezier curves the program sometimes forgets the position of the last mouse click, even though the line that the point just completed is displayed. This can be initially confusing, resulting in further mistakes that have to be corrected manually. Once you are able to spot when this 'bug' occurs, you'll just ignore it and mark the point again.

FROM BITMAP TO OUTLINE

Also included in the *Art Expression* package is an enhanced version of the excellent BitMap Editor (BME). Although similar to a conventional paint program, BME has been optimised for handling bitmapped images within DTP applications.

Although BME can handle images with up to 32 colours, all images shown on screen in 16 grey scales are at a reduced size. This enables images larger than the standard Amiga screen modes can handle (scans, for example) to be viewed. BME also enables you to tidy up images, cut out areas of graphics and crop images to any size.

What makes BME such a useful companion product to *Art Expression* is the inclusion of a new Trace function that looks, and in fact is very similar to the Trace utility bundled with Gold Disk's

Professional Draw. The Trace function will take any image loaded into BME and then literally trace around it to produce a structured version of your bitmap. BME gives you extensive control over the tracing process, although it has to be said that BME's Trace is nowhere near as good as the Trace utility bundled with *ProDraw*. Traced illustrations often exhibit signs of mismatching of colour areas which have to be tidied up by hand.

One nice aspect of the Trace function, though, is the way it actually shows you the bitmap being traced. Although this is not much use, it's a cosmetic feature that does come in handy because it quickly shows you how the trace is progressing. It can also help you adjust the trace parameters to ensure the best possible results.

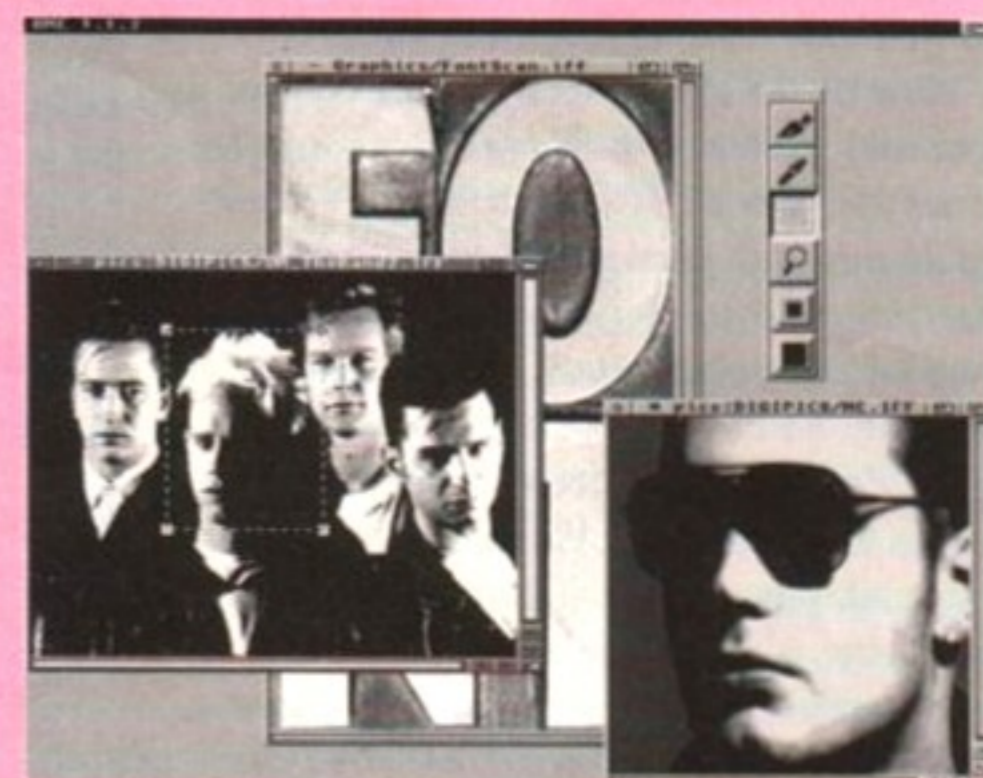

Soft Logic's BME is bundled with *Art Expression* and can convert bitmapped images into structured drawings.



You'll find within the program a plethora of editing tools that can be used to modify existing objects. The main toolbox window includes a selection of these, but further options are available from pull-down menus. All the usual editing features are here, including the ability to pull out individual points, add points, delete points, scale and rotate. These can be applied to more complex objects by grouping several of them into one.

Some *ProDraw*-like features make an appearance too, including a 'Blend' function that transforms one object into another using a sort of morphing technique. This proves useful when you want to add shading to your illustration – all you do is create the start and end sections of the shading, and then the program will smoothly blend the two objects together by creating shaded objects in-between.

If you need to create artwork in full colour, then *Art Expression* can do this too. Although it only runs in a 16-colour screen, it uses the same dithering techniques used by its rival to display an apparently larger number of colours.

Unlike *ProDraw*, *Art Expression* doesn't support Pantone colour selection, although their nearest equivalents can be defined using either mechanical or RGB values. To be per-

CREATING A CURVY CONTENDER

If the task of creating illustrations from scratch is a bit beyond you, then you can use BME's powerful Trace function to generate a structured image from any IFF image, produced by paint programs like *DPaint* pictured here. For the

best results, the image should be drawn at the highest possible resolution with a minimal number of colours. It's important to consider both the complexity and colour content of your drawings.



Once you've drawn your illustration in *DPaint* as a bitmap, the next step is to load it into BME and then run it through BME's Trace function. This can take a considerable amount of time – certainly a lot longer than Gold Disk's Trace

utility. One nice feature is that the Trace utility shows you the trace in progress, giving you a much better idea of what's going on.



With the trace complete, the resulting IFF DR2D file can be pulled directly into *Art Expression*. As you can see, the traced image will almost certainly need a considerable amount of touching up before it is useable.



Touching up the illustration is simply a process of pulling out curves and points so that all the areas that make up the object fit together perfectly. This is best done in wireframe mode, though you'll need to swap back to colour

mode to view the results. On an unaccelerated Amiga, swapping between modes can take an eternity, so try to do as much as you can in wireframe mode before swapping back to colour.



Here's the lemming in all his glory. He can now be saved to disk and imported into your favourite page-layout program or printed directly out on to paper. If you want to take your drawing further, there are a host of tools enabling

you to rotate, scale and skew to your heart's content.

fectly honest, though, Pantone isn't much use to most people, but many professionals insist on it. Extended screen support would be nice too – with the A1200 and A4000 now a couple of months old, surely Soft-Logic could have built-in support for the new AA chip set. You can bet that Gold Disk will when *ProDraw 4* finally hits the shelves.

One big advantage of *Art Expression* over its main rival is that it has full support for EPS files, which can be displayed in full colour and edited in the program. This is one area where *ProDraw* is really lacking – if you load an EPS file into *ProDraw*, it simply displays a grey box to indicate the image's boundaries. Rumour has it that Gold Disk will address this in the new release of *ProDraw*, so this won't be an asset for long.

Art Expression can also load in IFF DR2D files, a very rare format that is hardly used these days. Surprisingly, though, you are only provided with very limited support for Gold Disk's proprietary 'CLIP' format. Maybe this is a snub aimed at Gold Disk, but the fact remains that 'CLIP' is still the most popular format for structured images on the Amiga. If this is the case, then Soft-Logic are cutting off their nose to spite their face – after all, if 'CLIP' support had been built in, they could have extended their potential userbase by selling *Art Expression* to *ProPage* users too. As it is, all that *Art Expression* offers in terms of 'CLIP' file support is a small utility that converts 'CLIP' files to DR2D format. Unfortunately, the conversion process only works in one direction!

From first impressions, it looks like a real giant killer of a program, but continued use reveals its limitations. The lack of 'CLIP' file support, a rather flaky trace function (see separate box) and some rather temperamental editing tools proves frustrating. Soft-Logic's *PageStream* may have stolen the thunder from *ProPage*, but *Art Expression* certainly isn't going to leave *ProDraw* for dead. That's not to say that it is bad – it's just not qualified enough to justify its high price tag. Not only that, but *ProDraw* is still the most logical and easy to use of the two programs. I know which one I'm sticking with.

Art Expression
SPEED ●●●●

Art Expression redraws faster than *ProDraw*, but the user interface can be slow.

DOCUMENTATION ●●●●●

Soft Logic are well known for their well-written manuals and this one is no exception.

ACCESSIBILITY ●●●

You won't have any problems getting to grips with this program.

FEATURES ●●●●

Art Expression is absolutely packed to the gills with useful features.

VALUE ●●

Almost £170 is a lot of money, especially when you consider that *ProDraw 3* is £70 cheaper!



Discover the world of music

FUTURE MUSIC

MAKING MUSIC WITH MODERN TECHNOLOGY

COMPACT DYNAMITE!

JAM PACKED!
230
TOP SOUNDS!

- ◆ Over 200 superb samples
- ◆ Eight instrument demos
- ◆ The cream of reader demos



How does
he do it?

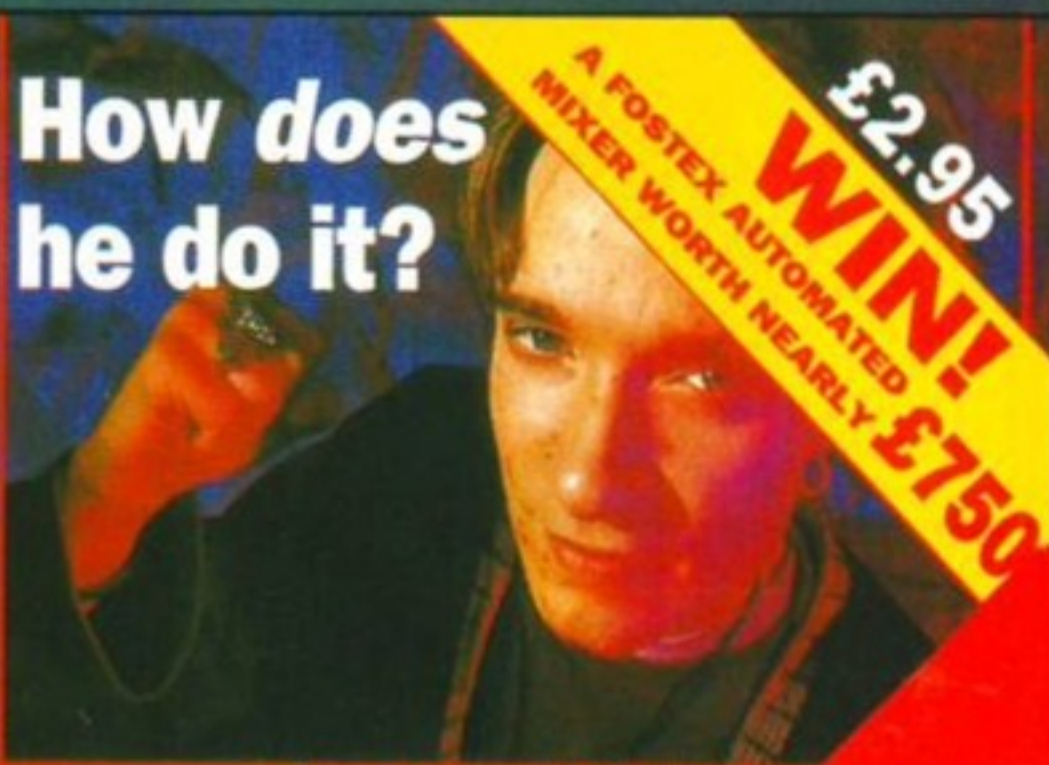

The Prodigy's
Liam Howlett tells all

£2.95
WIN!
A FOSTEX AUTOMATED
MIXER WORTH NEARLY £750

FUTURE MUSIC

Don't just
listen - play!

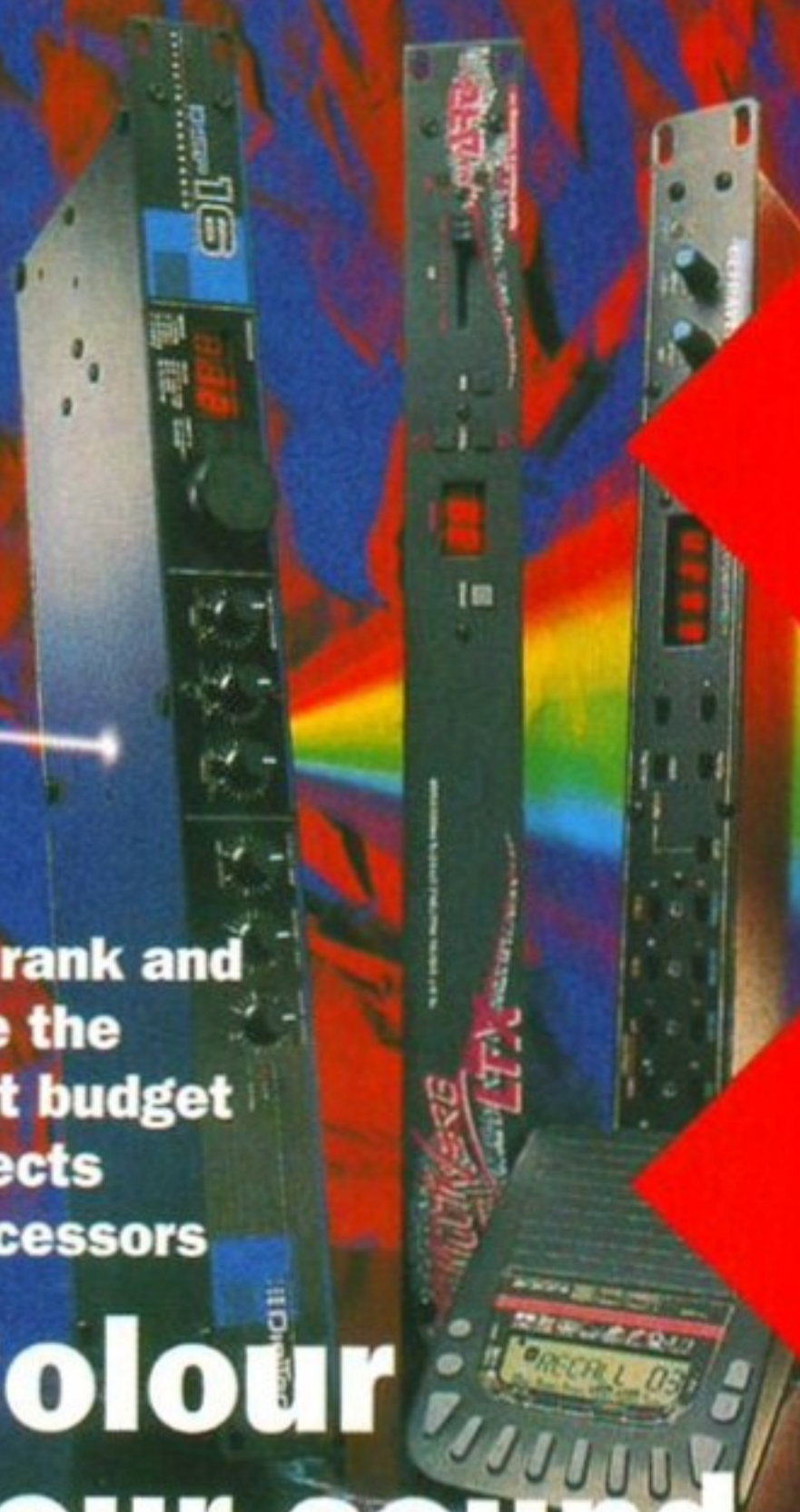

Creativity
plus technology

We rank and
rate the
best budget
effects
processors

Amazing sound-
packed CD

Colour your sound

ENSONIQ KS-32 REVIEW

Is this weighted-action
workstation the biz?
Discover all as we
hammer its ivories and
pound its parameters



YAMAHA QY20 Walkstation workout



ISSUE 4
FEBRUARY
1993

Future
PUBLISHING

Your guarantee
of value



Don't miss issue four of *Future Music*, in all good newsagents NOW!

Future PUBLISHING

Your guarantee of value

Amiga 600



- The compact Amiga
- 1MB of RAM
- Built-in TV modulator
- IDE Hard disk controller built-in
- PCMCIA Card slot
- Includes Power Mouse Mat
- Includes Apache joystick

Amiga 600	£285
Amiga 600 & 40MB HD	£455
Amiga 600 & 60MB HD	£499
Amiga 600 & 80MB HD	£549

Amiga 1200



- 32-bit computer
- 68020 microprocessor
- Optional 68881/68882 floating point unit
- 2MB RAM
- PCMCIA Card slot
- 16.8 million colour palette
- Displays up to 256,000 colours on screen
- Includes Power Mouse Mat
- Includes Apache joystick

Amiga 1200	£390
Amiga 1200 & 40MB HD	£560
Amiga 1200 & 60MB HD	£604
Amiga 1200 & 80MB HD	£654

Internal Hard Drive

40MB Internal hard disk	£199
80MB Internal hard disk	£269

Blizzard Turbo

- A500/A500+
- Expand up to 8MB (0K installed)
- Memory and 68000 CPU run at 14.28MHz
- Fast 68000 processor installed on-board
- Fully auto-configuring
- Optical 512K shadow RAM on extra memory bank for shadowing the operating system out of ROM or from disk

Blizzard Turbo	£129
Blizzard Turbo 2MB RAM.....	£185
B'Turbo 2MB RAM + 256K Shadow RAM	£199

Amiga 4000

- 32-bit computer
- 68040 microprocessor
- 25MHz clock speed
- 2MB 32-bit chip RAM
- Built-in 3.5" high density disk drive
- 16.8 million colour palette
- Display up to 256,000 colours on screen
- High resolution graphics
- AGA Custom chip set
- VGA or multiscan monitors
- AmigaDOS 3.0 & CrossDOS

Amiga 4000 & 120MB HD	£2329
-----------------------------	-------

A3000

- 68030 microprocessor with coprocessor
- 2MB RAM
- Hi-Res graphics with 1MB graphic RAM
- Built in SCSI interface
- Hard disk as standard
- 'T' is Tower version

Amiga 3000 & 52MB HD	£1439
Amiga 3000 & 105MB HD	£1569
Amiga 3000T 100MB HD 5MB RAM ..	£2349
Amiga 3000T 200MB HD 5MB RAM ..	£2936

PCMCIA Memory



- Ultra slim memory cards
- 1MB & 2MB
- For A600/A1200

1MB Memory card	£POA
2MB Memory card	£POA

Amiga Accessories

A2300 Genlock	£57
A2065 Ethernet Card	£245
A2232 Serial Card	£104
A2320 Display Enhancer	£163

Commodore 1960

- Multisync monitor
- For use with Flicker Fixers
- Very high quality

Commodore Trisync monitor	£479
---------------------------------	------

Educational discounts available

POWER

Power Computing Ltd
Unit 8 Railton Road
Woburn Road Ind. Estate
Kempston Bedford
MK42 7PN



Tel 0234 843388 Fax 0234 840234
Technical 0234 841882

48Hr delivery £2.50 24Hr delivery £4.50
Parcel post delivery £1 (U.K mainland only)

Specifications & prices are subject to change without notice
All trademarks acknowledged, VAT included

Home Music Kit



- The complete music kit for the Amiga

Digital Studio III

- Transform your Amiga into a digital sound studio
- Create your own music
- Re-mix songs
- Piece together various songs

Real Time Sound II

- Add special effects to music
- Over 32 special effects
- Echo effect
- Can work with MIDI instruments
- Each effect can be modified
- Make your voice sound robotic
- Allow your music to sound like it's being played in a concert hall

Stereo Sound Digitiser

- Convert your desired sounds into digital signals

Other Features

- Maximum sampling rate 900 KHz
- Dynamic filtering
- Anti-aliasing filter
- Stereo gain control by software
- Microphone volume scale

Home Music Kit	£49.95
----------------------	--------

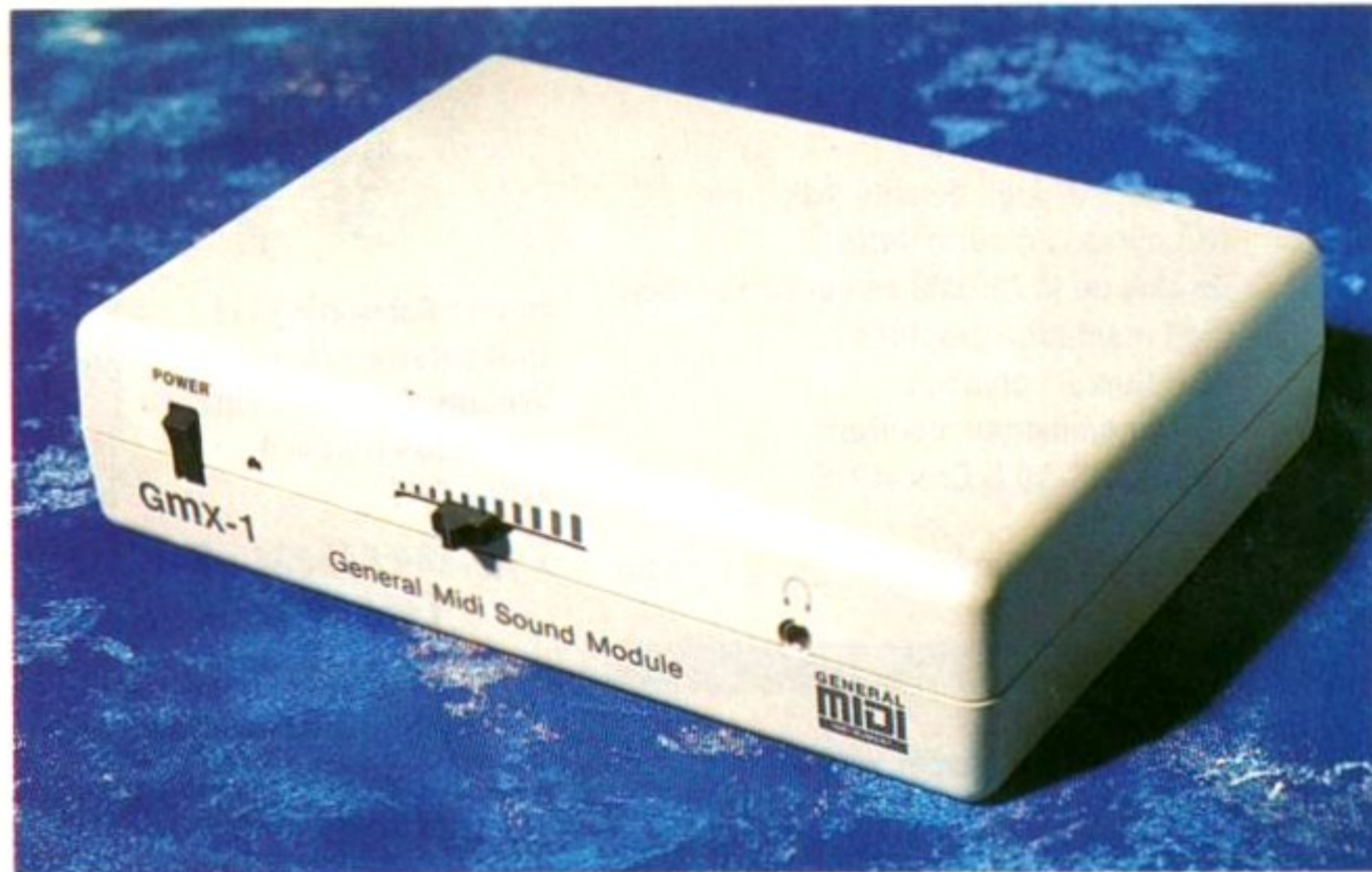

Neil Jackson, Amiga maestro and MIDI aficionado, takes a look at a box of tricks which can help your Amiga sing...

Looks just like a small white box, doesn't it? But it can provide your Amiga with MIDI compatibility, 158 instrument sounds, a full 92-piece percussion kit, plus 47 different sound effects.

new leads. Thus, it's really of more interest to the casual or beginner musician, rather than a professional artiste, but that's not a bad thing.

Despite this, the unit represents good value for money, and it is an ideal starting point for anyone interested in making music quickly and cheaply. The quality is good enough for performances – and it's how you use it that counts. The Dream GMX-1 uses the new MIDI standard called G-MIDI which allocates certain instruments to predefined patch numbers. This means you can create songs on the GMX-1 and then play them back on a different G-MIDI machine and still get the right type of instruments playing the right bits of the song.

The Dream GMX-1 comes complete with a Walkman-style headphone socket (so you don't have to annoy the neighbours), line-level stereo audio outputs (which you can plug into a household amplifier or even a mixing desk) and MIDI In, Out and Thru connectors (for connecting to other MIDI units). It gets its power from a 9V AC adaptor which is also supplied as part of the package. This is a strange choice, because if you lose it, a replacement adaptor isn't very easy to come by. It would probably have been easier and cheaper if Zone had used a DC adaptor, since this would have involved less circuitry inside the unit.

For the first-time buyer, the GMX-1 is an ideal purchase. It's simple to set up, easy to use and incredibly versatile for the price. You may well outgrow it in about a year, but it's far better value than anything else like it on the market. It's a good deal cheaper than the 'name' brands like Roland and Yamaha, and it performs the same tasks in exactly the same way, and produces similar results. And there's no point in spending cash for the sake of it, is there?

Dream GMX-1

G-MIDI Sound Module ■ £249 ■ Zone Distribution

THE AMIGA HAS never really made it big in the world of MIDI and music, but that's not to say that it can't do the job. Plenty of budding musicians use packages like *Music X* to create songs and control banks of MIDI keyboards from their humble A500s, but the problem has always been the cost of these out-board devices.

At last, though, there's a cheap alternative for the casual musician in the form of Zone Distribution's new desktop sound source, the Dream GMX-1. It's a fairly ordinary-looking white box, designed to sit alongside your Amiga and provide it with MIDI capability, 158 instrument sounds and a full 92-piece percussion kit, plus 47 different sound effects. Not bad for just under 250 quid, really.

For your money, you get a comprehensive sound source and a solution to your MIDI problems. The GMX-1 uses the standard RS-232-C port on the back of your computer as the pipeline for all the MIDI information. All you need is an RS-232 lead (which should cost less than a fiver) and some software capable of sending and receiving MIDI data via the RS-232 or serial port. *Music X* will do this for the Amiga, but there are plenty of alternatives

because the Amiga doesn't have an in-built MIDI port and most packages get round this by using RS-232 anyway. You don't even need to buy a separate MIDI expansion box, because the Dream GMX-1 does all that itself, and provides you with more MIDI ports to link to other MIDI devices.

The Dream GMX-1 performs well, and produces surprisingly good sounds considering it uses a combination of PCM samples overlaid with algorithmic synthesis (like the Yamaha DX range of keyboards). It's got 20 note polyphony (sounding different notes at the same time) and it can even handle 16 different timbres or sound shapes simultaneously.

Many more-expensive machines would struggle to match its banks of preset sounds. But that's really all you get with the GMX-1 – presets. You can control a few things, like aftertouch, velocity, pitch-bend, modulation and pan – though that's about it. There's no patch-editing to be done, and no reverb chorus or echo effects to be had. Any effects units you own have to be added after the Dream GMX-1's outputs, and this means a uniform effect for all instruments, and perhaps a few

DREAM GMX-1 is available from Zone Distribution
071-738 5444

AROUND THE BACK...

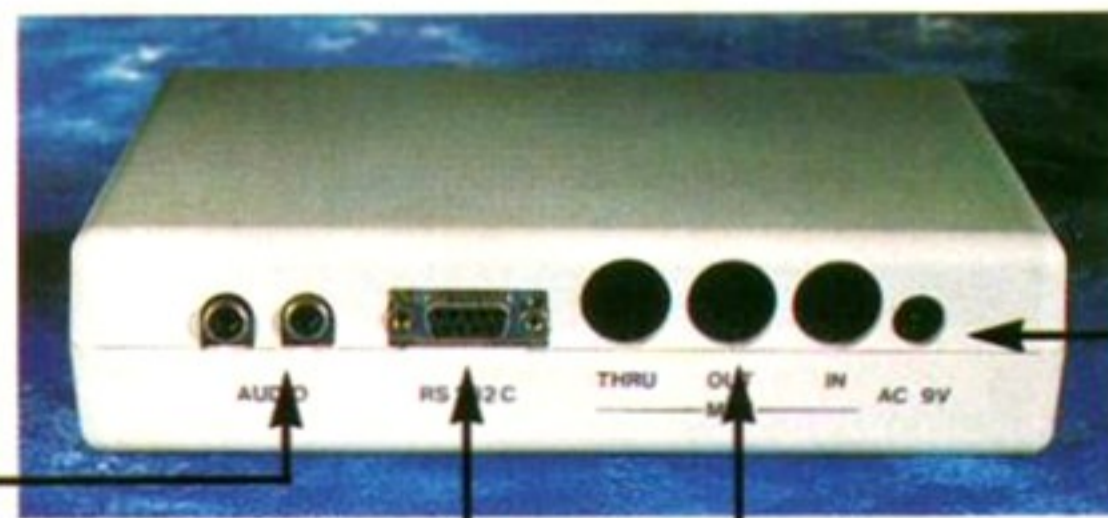

Stereo audio output, for connecting to your hi-fi amplifier or monitor speakers.

RS232C port, to connect directly to your Amiga – so there's no need for a MIDI interface!

MIDI IN, OUT and THRU, for connection to other MIDI instruments and sequencers.

9V AC input, for connection to the mains using the supplied adaptor.

Dream GMX-1 G-MIDI Sound Module

SPEED ●●●●

As fast as any other MIDI device, and it can cope with a large amount of MIDI data.

DOCUMENTATION ●●●

It's a bit cheap and nasty, but it tells you everything you need to know.

ACCESSIBILITY ●●●●

It couldn't be simpler to use. All you need is an RS 232 lead and some MIDI software.

FEATURES ●●●●

There aren't a vast range of features on the GMX-1, but what there are work well.

VALUE ●●●●●

There's nothing quite like it at this price, which makes it great for first-timer buyers.



86%



THE FINAL WORD

...in Word Processing with Perfect Printing

From the makers of Pen Pal comes a brand new, unique WYSIWYG Word Processing package, that's simply the only choice for those who demand the most from their Amiga.

Final Copy II is not only the Amiga's most powerful Word Processor with every feature you'd expect - plus many more found normally in DTP packages - but also the only Word Processor that gives superb scaleable outline fonts from any Amiga - even 1.3's. Imagine outputting to your printers highest resolution, with almost Postscript™ laser perfection - no matter which printer you may have. Even with a simple nine pin dot matrix you'll get perfect printing* from Final Copy's 20 smooth outline typefaces that are included!

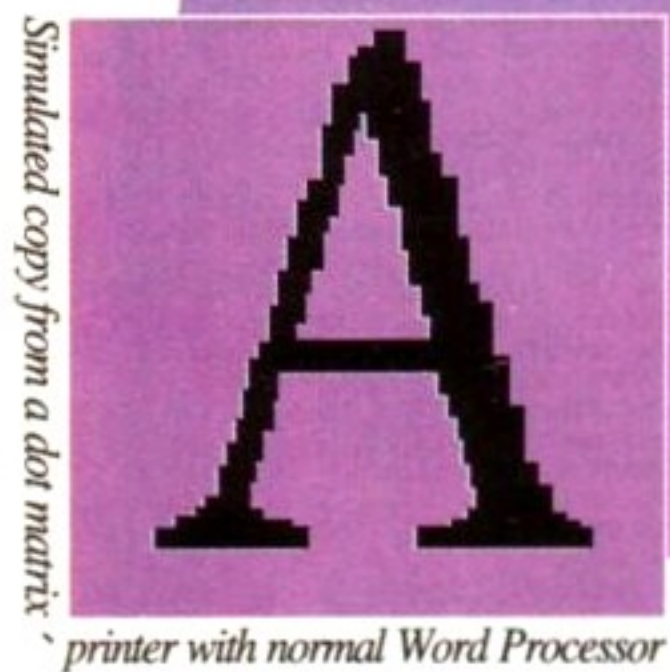

Simulated copy from a dot matrix printer with normal Word Processor



Final Copy II

Word Processor for the Amiga®



from SoftWood, Inc.
the makers of
Pen Pal



With its powerful new features, there's no better Word Processor/Publisher for your Amiga. You'll quickly realise the benefits which were once the exclusive preserve of the Macintosh™ and other high end publishing systems.



With multiple newspaper style columns and integrated drawing tools - for boxes, borders, squares, lines at any angle, ovals, circles, arrows etc., plus colour text, along with many other formatting tools - your documents will look and read just as you want them to.

Final Copy II includes a 110,000 word British-English Collins Proximity Spelling Detector & Corrector, to help typing errors become a thing of the past, along with an 826,000 synonym Thesaurus, for that extra inspiration.

Final Copy II is so easy to learn and use, that you'll become an accomplished author in no time at all - but if you need extra help you're not on your own as our support hotline is there for all UK version users. Look out for the UK logo on the box!

...Final Copy II

Only £99.95

FROM ALL GOOD SOFTWARE DEALERS

Compatible with...

Amiga - A500/600/600HD/1500/2000/3000.
System requirements... min. of 1Mb. RAM and two Floppies or a Hard Disk Drive [A600HD requires at least 1.5Mb].

*Any Workbench supported graphic printer, colour or mono, including... Citizen 120D, 124D, 224, Swift 9/24, 200/240; Star LC10, 20, 200, 24-200, and XB Series; Canon BJ10ex; HP Ink/Paintjet; Postscript™ devices and many more.

Trade Distribution by...

Centresoft/IBD ♦ HB Marketing ♦ Leisuresoft ♦
Meridian Distribution ♦ SDL/Prodis ♦
Dealers... Please call Harwoods for your supply of leaflets and inclusion in the list of stockists we provide to customers.

United Kingdom version imported & supported by...

GORDON HARWOOD Computers

Gordon Harwood Computers • New Street • Alfreton Derbyshire • DE55 7BP • Telephone: 0773 836781

Final Copy II encompasses a whole range of other advanced features, here's just a selection:

- ◆ Uses the latest Workbench 2 Style interface on all Amigas
- ◆ On screen command ribbon controls (format your document with the simple touch of a button)
- ◆ 25% to 400% editable page reduction and magnification command
- ◆ Title page, master pages & style sheets
- ◆ Right/left pages with binding offset
- ◆ Open multiple documents
- ◆ Fast mouse document panning and zoom/un-zoom
- ◆ External and internal mail merging
- ◆ Cut, copy and paste
- ◆ Search and replace
- ◆ On screen maths
- ◆ Auto-hyphenation
- ◆ Import, resize and crop IFF, HAM and 24Bit ILBM graphics and auto-flow text around them
- ◆ Text over graphics
- ◆ Outline fonts on all Amiga screens, and any non-Postscript™ or Postscript™ compatible printer
- ◆ 4 point up to 300 point [over 4" high] smooth text printing
- ◆ Text leading and spacing controls
- ◆ Condensed and expanded characters
- ◆ Positive and negative obliquing
- ◆ Background printing, allowing simultaneous editing & printing of two or more documents
- ◆ Fast proof printing facility
- ◆ Comprehensive range of additional attractive font volumes available.

E. & O. E.



Please rush my personal copy of the new Final Copy II information pack, including samples from popular printers, and a list of stockists to... [clip the coupon or call 0773 836781 now!]

Name & Address:

Please include your postcode
AMF 3/93

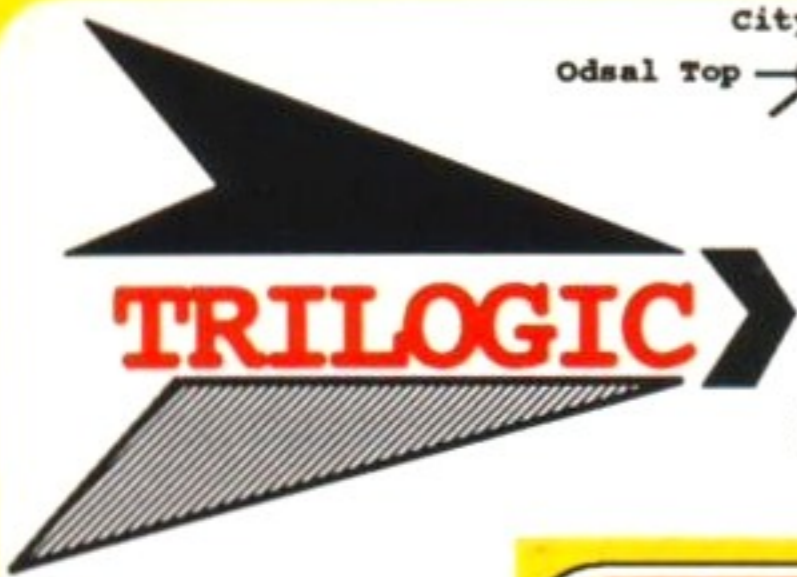

Callers welcome Open Mon Fri 8am-6pm, Sat 8am - 4pm. SUN 10-4pm
 NOW OPEN SUNDAY 10-4PM.
 We're easy to find, just 1.5 miles from the M62. Easy parking. Leave M62 at junction 26, take A638 to Bradford, uphill, after about 1.5 miles & just past the park, turn left onto New Works Rd, just over a railway bridge. We're on the left 400yds further on opposite a PO mail box.

UNIT 1,
 253 NEW WORKS RD,
 BRADFORD, UK,
 BD12 0QP

SALES
 0274 69 11 15
 FAX 0274 60 01 50

**ACCESS, VISA,
 SWITCH, DELTA
 CONNECT
 AMERICAN
 EXPRESS**
 FAST MAILORDER SERVICE
 SAME DAY DESPATCH*

ORDERING IS EASY
 1) Order by phone using your credit, charge, or debit card.
 2) Order by Mail - sending cheque bankers draft or postal orders payable to TRILOGIC.
 3) Please add part postage & packing of £1.00 to small orders under £100 or £2.00 to small orders over £100. Large/heavy items sent overnight only - £5.50
 Overnight carrier £5.50 extra. UK Mainland only. Scottish Highlands £7.50 extra. Saturday delivery - add £12.00
 Goods remain our property until paid for in full.
EXPORT ORDERS WELCOME
 None EC countries - deduct 15% add carriage. For EC Countries - UK vat must be charged from 1-1-93. Please contact us for carriage charges.
MINIMUM PRICES & PROFESSIONAL SERVICE - at NO EXTRA COST
 Our policy is & has been for the last 8 years, to:
 1) Send orders within 24hrs subject to goods being in stock.
 2) Endeavour to keep at least 90% of advertised items in stock.
 3) Only charge prices different from those advertised due to unavoidable manufacturers price increases & to inform you of any change at the time of ordering.

DIGITISERS, GENLOCKS, SCANNERS & ENHANCERS

- ROCGEN PLUS NOW ONLY £139.99**
 A superb value Genlock with overlay & fader controls + RGB pass thru.
- RANDY SCANNER £94.99**
 In our experience, this is by far the best B/W hand scanner in this price bracket. 400dpi, 64 level grey Scale + excellent DataScan Professional 2 software.
- ROC KEY Chroma keying unit £269.99**
 The ideal partner for the RocGen Plus. This add-on 'Keying' unit enables professional effects such as Chroma keying, luma keying, Key through, Graphics overlay, key window etc
- VIDI 12 £82.99** NEW Colour Frame grabber/digitiser.
VIDEOMASTER £59.99 VIDEO & AUDIO DIGITISER IN ONE
SUPERPIC £509.99 Frame grabber, colour digitiser & genlock.
COLOURPIC £409.99 Frame grabber & colour digitiser in one unit.
REDALE S802 GENLOCK £135.99 Low cost hi-spec budget genlock.
REDALE SUPER S802 SVHS £493.99 Semiprofessional SVHS Genlock - excellent value. Foreground & background modes; Super VHS input & output; Composite video input & output; hardware controlled fades; cross fade Amiga to video; fade to black; several powerful 'wipes'. **VERY GOOD VALUE FOR MONEY**
DCTV £389.99 External graphics enhancer for all Amigas.
MEDIASTATION £122.99 Comprises DIGIVIEW GOLD video digitiser (the best for use with a camera) + DIGIPAIN 3 + ELAN PERFORMER. **SAVE £17.00**
FLICKER FREE VIDEO 2 £229.99 Fits inside your A500,500+ 1500 or 2000 & eliminates annoying flicker. Latest improved version. Requires VGA or Multisync monitor. Compatible with ALL Amiga video modes. Overscan capability for full screen display. No visible scan lines.
FLICKER FILTER FOR AMIGA 1500/2000 £209.99 WITH BUILT IN STEREO AMPLIFIER
EPSON 07 6000 COLOUR SCANNER £879.99 PRICE DOWN Professional quality Flat bed colour scanner capable of resolving 16.7 Million colours; or 256 level grey scale at 300dpi resolution. Includes free Amiga driver.

SPECIAL PRODUCTS

- SUPERPI 2 STEREO SYSTEM - HI FI QUALITY 20 WATTS/CH**
 We've looked high & low for a POWERFUL, TOP QUALITY Stereo speaker system for use with most Computers, keyboards, Stereo VCRs, Satellite Systems & Walkmans. Now we've found one - it is a 20 watt per channel, directly mains powered, 3 way speaker system. It has Bass, treble & volume controls & comes with connecting leads. Frequency response: 32Hz - 20KHz. **ONLY £54.99**
ALSO AVAILABLE - EYFI STEREO SYSTEM - latest model only £32.99
- AMIGA ROM SWITCH SIMPLE TO FIT Only £27.99**
 Our Keyboard operated Two way Rom switch enables you to use either of 2 Workbench rooms. To switch over, just hold down Control/Amiga/Amiga keys until you hear a bleep. (Release them before the bleep to 'warm start' with the current rom. Fits A500/500+/1500/2000. Fitting invalidates computer warranty unless fitted by us. Fitting charge £15.00 Please state which you have Amiga when ordering.
ROM SWITCH & 1.3 ROM only £54.99 **ROM SWITCH & 2.04 ROM only £64.99**
- 5 PORT PRO-MIDI INTERFACE £24.99**
 Our unique 5 port Midi interface has In, Out & Thru sockets plus two additional switchable Out or Thru sockets for ingenious versatility. So you can have 1 in, 1 out & 3 thru, or 1 in, 1 thru & 3 out, or 1 in, 2 outs & 2 thru!
 Fully compatible with all Amiga Midi software, & most keyboards.
 Extra Midi leads 1.2m - £1.99 3m - £2.99
- STEREO SAMPLER 2 NOW ONLY £34.99**
 Our Superb sounding STEREO SAMPLER 2 uses an expensive state of the art A/D chip which samples so fast, it captures every detail of the sound. Easily adjusted level control, connecting lead supplied. Fully compatible with all popular sampling software.
FREE STEREO SAMPLING SOFTWARE

MOUSE & JOYSTICKS

- ULTIMATE PRO ANALOGUE JOYSTICK NOW £19.99**
 Superb low cost smooth action Analogue joystick with fire button on the end, plus prestorable X & Y trimmers, Microswitch fire buttons; autofire (not all games support autofire) Ideal for flight simulators etc (Not all games support analogue joysticks)
- MOUSE / JOYSTICK PORT SWITCH £12.99**
 * Has sockets for mouse & joystick.
 * Push button selects mouse or joystick
 * Uses no power unlike other types.
 * Saves wear & tear on mouse port.
- NAKSHA MOUSE + OPERATION MANUAL OUR PRICE £24.99**
 Includes Mouse mat & holder
- BUDGET REPLACEMENT MOUSE £14.99
 SQUICK MOUSE £15.99
 PYTHON JOYSTICK £9.99
 TOPSTAR JOYSTICK £19.99
 DELTA 3A ANALOGUE JOYSTICK £14.99
 PRO 5000 MINI - BLACK £10.99
 KIPSTICK AUTOFIRE £12.99
 SPEEDKING AUTOFIRE £11.99
 SPEEDKING ANALOGUE £11.99
 OPTICAL MOUSE £37.99
 MOUSE MAT £3.99
 MOUSE HOLDER £1.99
 JOYSTICK EXTENSION LEAD (3m) £2.49
 PC ANALOG JOYSTICK CONVERTER £7.99

AMIGA PRINTER PORT EXPANDERS

FOR USE WITH PRINTERS, SAMPLERS, VIDEO DIGITISERS, SCANNERS ETC
 These compact fully Switched Expansion boxes enable you to connect up four peripherals to your computer. The connectors on the units are the same type as the Computer's printer connector so your peripherals just plug straight in. A connecting lead worth £10.99 - 2m for use with printers only, or 300mm long if used with Digitisers, scanners & samplers (state which req'd) is supplied free, to link the Expander to the computer. All 25 connections are switched, ensuring isolation of connected devices.
2way - £24.99 **3way - £27.99** **4way - £29.99**

TWO WAY SCART SWITCH £17.99
 This compact switch box converts most TVs & Tv monitors to DUAL SCART INPUT. Thus you can connect your Amiga & your VCR to the one scart socket on your TV. A push button switch selects input one or input two - ie VCR or computer. RGB, Audio & Video inputs are switched.

SPARES, ACCESSORIES & MISC ITEMS

- BLANK DS/DD 3.5" DISKS (TDK OR DYSAN) IN BOXES OF 10 WITH LABELS £7.99**
 2 boxes for £15.00; 5 for £30; 10 for £55
- 3.5" DISK BOX FOR 40/50 DISKS £6.99
 3.5" DISK BOX FOR 80 DISKS £7.99
 3.5" DRIVE HEAD CLEANER £3.99
 PATTEN AGRUS 8372A £39.99
 SUPER DENISE £39.99
 GARY £39.99
 8520A I/O CHIP £15.99
 1MBG x 9 SIMMS £29.99
 4MBG x 9 SIMMS £99.99
 256Kx4 DRAMS for A590 1mbg £32.99
 AMIGA INTERNAL DRIVE £59.99
 MAINS SUPPRESSOR BLOCK 4WAY £12.99
 UPRATED A500 POWER PACK £44.99
 A590 REPLACEMENT PSU £94.99
 GVP REPLACEMENT PSU £64.99
 EXTERNAL DRIVE PSU £29.99
- UPGRADE YOUR AMIGA. OFFICIAL 2.1 UPGRADE KIT INC 2.04 ROM, WORKBENCH DISKS & FULL RING BOUND MANUALS - £79.99**
- KICKSTART 1.3 ROM £29.99
 KICKSTART 2.04 ROM £39.99

AMIGA SERVICE DEPT

AMIGA 500 REPAIR £49.99
 Includes parts & labour, excludes PSU, disk drive & keyboard faults.
 A520 MODULATOR REPAIR £19.99
 REPLACE INTERNAL DRIVE £69.99
 A500 PSU REPAIR £29.99
 Add £10 for same day turnaround (by prior arrangement only)
 Call in or send by registered post enclosing £5.50 for return carr.

BOOKS & VIDEOS

- * DISK INCLUDED WITH THESE BOOKS
 AMIGA FOR BEGINNERS £14.99
 AMIGA BASIC INSIDE & OUT £21.99
 C FOR BEGINNERS £17.95
 DISK DRIVES INSIDE & OUT £27.95
 DOS INSIDE & OUT £22.95
 DESKTOP VIDEO £23.95
 GRAPHICS INSIDE & OUT £31.95
 IMAGINE COMPANION £24.95
 LITTLE BLUE WRENCH BE £14.95
 MAKIN MUSIC ON THE AMIGA £27.99
 USING AREXX ON THE AMIGA £26.99
 USING DELUXE PAINT £19.95
 UNDERSTANDING IMAGINE 2 £24.95
 USER INTERFACE MANUAL £18.99
 HARDWARE REF MANUAL £21.95
 ROM KERNEL REF MANUALS - EACH £28.95
 VIDIA PAGESTREAM GUIDE £4.95

BRUCE SMITH BOOKS

- MASTERING AMIGA DOS VOL 1 £21.95
 MASTERING AMIGA DOS VOL 2 £19.95
 MASTERING WORKBENCH 2 £19.95
 MASTERING AMIGA C £19.95
 MASTERING AMIGA PRINTERS £19.95
 MASTERING AMIGA ASSEMBLER £24.95
 MASTERING AMIGA SYSTEM £29.95
 MASTERING AMIGA AMOS £19.95
 MASTERING AMIGA AREXX £79.95
 MASTERING AMIGA - BEGINNERS £19.95
 A600 INSIDER GUIDE £14.95
 BEGINNERS AMIGA VIDEO only £14.99
 Covers: Workbench 2; Icons, Screens, Workbench menus; diskformatting & duplicating; Using Preferences; Adding memory; Adding peripherals - digitisers, genlocks; Using CLI; Changing the Startup sequence etc etc - 80mins long. Excellent!
 ALL MAIN AMIGA MAGAZINES IN STOCK PLUS SOME BACK ISSUES.

DUST COVERS

- 'SEAL n TYPE' TYPE THRU KEYBOARD SKIN.
 Don't risk spillages - they're guaranteed to 'write off' your Amiga. Waterproof & moulded to fit snugly over each key, but flexible enough to type thru.
 AMIGA 500, 500+, 600, 1200, 1500 State which when ordering .. £10.99
ANTISTATIC DUST COVERS
 AMIGA 500 & 500 Plus £3.99
 AMIGA 600/600HD/1200 £3.99
 AMIGA 1500/2000 2PIECE £12.99
 AMIGA 1500/2000 KEYBOARD £3.99
 3.5" EXTERNAL DRIVE £2.99
 8833/1084 MONITOR £6.99
 SWIFT 9, LC200 PRINTER £6.99
 SWIFT 24/LC24-200 £6.99

DISCOUNT AMIGA SOFTWARE

- ALL SOFTWARE UK VERSIONS
- ADORAGE £67.99
 AMI ALIGNMENT £42.99
 AMIBACK £44.99
 AMAS 2 £69.99
 AMOS £34.99
 AMOS - EASY £22.99
 AMOS 3D £23.99
 AMOS COMPILER £20.99
 AMOS PROFESSIONAL - NEW £45.99
 AREXX V1.1 £34.99
 ART DEPT PRO save £25 £124.99
 ART EXPRESSIONS NEW £154.99
 AUDITION 4 £37.99
 AUDIOMASTER 4 £59.99
 AUDIO ENGINEER 2 £165.99
 BARS & PIPES £109.99
 BARS & PIPES PROFESSIONAL £224.99
 BROADCAST TITLER 2 £169.99
 CAN DO V2 NEW VERSION £99.99
 CASHBOOK CONTROLLER/FINAL A/C'S £54.99
 CROSS DOS V5 inc PC emulator £22.99
 DAY BY DAY £22.99
 DELUXE PAINT 4.13 DOWN £64.99
 DELUXE MUSIC £49.99
 DELUXE VIDEO 3 £69.99
 DEVPAC 3 - new version £51.99
 DG CALC £29.99
 DIRECTORY OPUS £29.99
 DISK MASTER £39.99
 DISK MASTER 2 £49.99
 DOS TO DOS £29.99
 E TYPE £24.99
 EXPERT DRAW £49.99
 EXPERT 4D JNR £35.99
 EASY AMOS £22.99
 EXCELLENCE 2 £59.99
 EKOTIC CARS FOR IMAGINE £34.99
 FINAL COPY 2 LATEST VERSION £71.99
 FLOW v3.0 £59.99
 GB ROUTE PLUS - PRICE DOWN £42.99
 GALLERY - NEW DATABASE £59.99
 GOLD DISK OFFICE 2 NEW £94.99
 GOLD DISK OFFICE PORT PK £34.99
 HIGH SPEED PASCAL £69.99
 HISOPT BASIC £44.99
 HI SORT BASIC EXTENSIONS £19.99
 HOME ACCOUNTS 2 £39.99
 HOMEBASE £24.99
 HOTLINKS £49.99
 HOTLINKS EDITIONS NEW £69.99
 HYPERBOOK £44.99
 IMAGINE 2 £199.99
 IMAGINE OBJECTS DISK £84.99
 IMAGINMASTER - NEW PRICE £124.99
 INTROCAD PLUS £74.99
 KINDWORDS 3 PRICE DOWN £39.99
 LATTICE C V6 /SAS C NEW £209.99
 MACRO 68000 ASSEMBLER £39.99
 MAILSHOT PLUS £37.99
 MASTER SOUND £34.99
 MASTERPLAN V4 £89.99
 MEDIA SHOW £51.99
 MEGAMIX MASTER NEW £29.99
 MINI OFFICE - BARGAIN £39.99
 MORPH PLUS £149.99
 MUSIC X £36.99
 ORGANISE £46.99
 ON LINE PLATINUM £34.99
 PAGESTREAM 2.2 £125.99
 PAGESTREAM 3 £34.99
 PAGESTREAM FONT PACKS £41.99
 PAGESTREAM BUSINESS FORMS £34.99
 PERSONAL TAX PLANNER £29.99
 PERSONAL FINANCE MANG £39.99
 PERFECT SOUND £59.99
 PROFESSIONAL CALC £139.99
 PRODATA 1.2 £69.99
 PROFESSIONAL PAGE 3 £179.99
 110 FONTS FOR PROPAGE £109.99
 PROTECT 5.52 £59.99
 PROMWRITE v 3.3 - NEW VERSION £59.99
 QUARTERBACK 5 £44.99
 QUARTERBACK TOOLS £49.99
 QUARTET £37.99
 SCALA 500 £74.99
 SCALA PROFESSIONAL £199.99
 SCULPT 3DXL £109.99
 SCULPT ANIMATE 4D JNR £94.99
 SONIX £34.99
 SOUNDMASTER £99.99
 STEREO MASTER £29.99
 SUPERJAM V2 NEW £74.99
 SUPERBASE PROP 4 LOW PRICE £155.99
 SUPERPLAN £69.99
 SYSTEM 3e £57.99
 TAKE 2 £39.99
 TECHNO SOUND £29.99
 TURBOPRINT PRO V2 NOW ONLY £35.99
 VIDEOMASTER £59.99
 WORDMOUTH 2 - NEW VERSION £84.99
 XCAD 2000 £109.99
- SPECIAL OFFERS**
 EDUCATIONAL COMPENDIUM 6 £29.99
 Excellent Value boxed set comprising:
 * WORDS & NUMBERS * KID'S TYPE
 * GAME SET & MATCH * WEATHER WATCHER
 * WHAT IS IT WHERE * CALENDAR QUIZ IS IT ?
- 'MIRACLE' MUSIC KEYBOARD SYSTEM**
 "The Piano that teaches you how to play"
 Includes 4 octave FULL SIZE Keyboard, 100 Instrument sounds & effects. "Artificial intelligence" software for the Amiga which customises the lessons to each individual.
 Our price £279.99 save £20.00
- TOP 50 GAMES**
- A320 AIRBUS £26.99
 ASSASSIN £18.99
 ARCHER MACLEANS POOL £18.99
 BIRDS OF PREY £25.99
 BC KID £18.99
 CHAMPIONSHIP MANAGERS £18.99
 CAMPAIGN £24.99
 CEASAR £21.99
 CIVILISATION £24.99
 COOL WORLD £18.99
 CRAZY CARS III £18.99
 CURSE OF ENCHANTIA £25.99
 CYTRON £22.99
 DARKSEED £26.99
 EYE OF THE BEHOLDER II £26.99
 FINAL FLIGHT £18.99
 FIRE & ICE £18.99
 FORMULA 1 GRAND PRIX £25.99
 F15 STRIKE EAGLE II £25.99
 GRAHAM TAYLORS SOCCER £18.99
 GORILLIENS £18.99
 HAGAR THE HORRIBLE £18.99
 HEAD TO HEAD £18.99
 HUMANS £21.99
 INTERNATL SPORTS CHALL £21.99
 ISHAR £19.99
 INDIANA JONES & FATE OF ATLANTIS £18.99
 INDIANA JONES - ADVANCED £26.99
 JIMMY WHITE'S SNOOKER £21.99
 KNIGHTS OF THE SKY £26.99
 LETHA WEAPON £18.99
 LEGEND OF KYRANDIA £25.99
 LEEDS UNITED CHAMPIONS £18.99
 LIMBS £24.99
 LINKS COURSES £12.99
 LURE OF THE TEMPTRESS £21.99
 JAGUAR XJ220 £18.99
 JOHN BARNES FOOTBALL £18.99
 LOTUS TURBO 3 £18.99
 MONKEY ISLAND 2 £26.99
 NIGEL MANSELLS WORLD CHAMP £21.99
 PGA TOUR GOLF + £21.99
 PINBALL DREAMS £18.99
 PINBALL FANTASIES £21.99
 POPULOUS 2 £19.99
 POPULOUS 2 PLUS £25.99
 PREMIERE MANAGER £18.99
 PROJECT X £18.99
 PUSHOVER £18.99
 PUTTY £18.99
 RAMPART £18.99
 RAVING MAD £18.99
 RED BONE £18.99
 ROAD RASH £18.99
 ROBOSPORT £21.99
 SAIRE TEAM £18.99
 SENSIBLE SOCCER 92/93 £18.99
- SPECIAL OFFERS**
 GFA BASIC £9.99
 XCOPY PRO - PREVIOUS VERSION INC MK1 CYCLONE ADAPTOR - £27.99
- MORE AMIGA GAMES**
 SILENT SERVICE 2 £25.99
 SHADOW OF THE BEAST III £21.99
 STREET FIGHTER II £18.99
 STRIKER £18.99
 SHUTTLE £22.99
 SWORD OF HONOUR £18.99
 THE MANAGER £18.99
 TRODDERS £18.99
 VIKINGS £25.99
 WIKED £18.99
 WING COMMANDER £26.99
 WWF WRESTLEMANIA £18.99
 WWP 2 £18.99
 ZOO £18.99
 ZOO 1200 £18.99
- COMPILED**
 BIG BOX 2 - 10 GAMES £22.99
 CARTOON COLLECTION £17.99
 COMBAT CLASSICS £21.99
 DREAM TEAM £18.99
 FANTASTIC WORLDS £26.99
 FLIGHT COMMAND £18.99
 FOOTBALL CRAZY £18.99
 INTELLIGENT STRATEGY GAMES £18.99
 LEMMINGS TWIN PACK £22.99
 MEGA SPORTS £18.99
 QUEST & GLORY £22.99
 SUPERFIGHTER £18.99
 ZOO PACK £29.99
- TOP SEGA MEGADRIVE GAMES ALSO STOCKED AS DISCOUNT PRICES

ALL PRICES INCLUDE VAT
SALES: 0274 - 691115

OPEN SUNDAY 10-4PM
SEE OPPOSITE PAGE FOR 'HOW TO ORDER'

TRILOGIC

AMIGA 600
'WILD, WEIRD & WICKED' £779.99

- > MOUSE
- > 1MEG RAM
- > 3.5" DISK DRIVE
- > WORKBENCH 2
- > BUILT-IN TV MODULATOR
- PLUS
- > DELUXE PAINT 3
- > GRAND PRIX
- > PUSHOVER
- > PUTTY

ALL 600s HAVE FREE 12 MONTHS ON-SITE WARRANTY

Add £42.99 for 2 meg versions

AMIGA 600HD
'EPIC' PACK' £779.99

- > MOUSE
- > 1MEG RAM
- > 3.5" DISK DRIVE
- > 20MEG HARD DRIVE
- > WORKBENCH 2
- > BUILT-IN TV MODULATOR
- PLUS
- > TRIVIAL PURSUITS
- > EPIC
- > MYTH
- > ROME

AMIGA 600 STANDALONE
£277.99

- > MOUSE
- > 1MEG RAM
- > 3.5" DISK DRIVE
- > WORKBENCH 2
- > BUILT-IN TV MODULATOR

ZOOL PACK ONLY £19.99 with any Amiga.

* SOOL	rrp	£25.99
* PINBALL DREAMS	rrp	£25.99
* STRIKER	rrp	£25.99
* TRANWRITE (Wordprocessor)	rrp	£49.99
TOTAL VALUE		£127.96

UPGRADE YOUR 600.

WORKBENCH 2.1 UPGRADE INC ROM £79.99
Similar to Workbench 3 - many new features & utilities.
2 & 4 MEG FAST MEMORY CARDS IN STOCK
1MEG INTERNAL RAM CARDS IN STOCK
INTERNAL HARD DRIVES FROM UNDER £120
AMIGA 600 DELUXE MONITOR STATION / CONTROL CENTRE £49.99
AMIGA 1200 DELUXE MONITOR STATION / CONTROL CENTRE £49.99
Comprises colour matched steel stand for monitor/tv; shelf under for Psu & external drive etc; Mouse & Joystick port extension cables; mouse holder; mouse mat & Large dust cover covers monitor & computer.

STOP PRESS - HURRY - BEAT THE PRICE RISES COMMODORE ANNOUNCE PRICE INCREASES ON ALL AMIGAS FROM 1-1-93

AMIGA 1200

ASTOUNDING SPEC:

- 68020 32BIT Cpu
- 14.19MHz CLOCK SPEED
- 2 MEG RAM
- 3.5" FLOPPY DRIVE
- 16MILLION COLOUR CAPABILITY
- BUILT-IN TV MODULATOR
- WORKBENCH 3, MOUSE & PSU
- 32 BIT EXPANSION PORT

FREE ON SITE WARRANTY

PHONE FOR LATEST LOW PRICE
NOW ALSO AVAILABLE WITH HARD DRIVES INSTALLED

FAST HARD DRIVES FOR YOUR AMIGA 600 & 1200.

20MEG: PRICES
40MEG: FROM
60MEG UNDER
80MEG £120

BOOTS UP IN LESS THAN 10 SECONDS

* Prices include drive cable.
(Cable also available separately for £9.99)
* Formatted ready to use.
* Easy to fit - installs in second - attach to internal drive bay bracket (screws included) & plug-in the cable - that's all there is to it. Fitting charge £15.00. Send your 1200 by registered post, enclosing £5.50 extra for return carriage - don't forget the Extended warranty if required - £42.99 extra - highly recommended.

SPEED UP YOUR 1200
Adding one of our 32bit FAST RAM cards will give from 2 to 30 times speed increase over a standard 1200 (from 6 to 70 times faster than a A500 - largest increases are for maths intensive applications, making use of the 68881/68882 co-processors on the Ram cards.

NO AMIGA REPAIR BILLS FOR 2 or 3 YEARS

WHEN YOU TAKE OUT AN EXTENDED WARRANTY WITH US. Underwritten by a leading UK Insurance Co. COVERS BREAKDOWNS & ACCIDENTAL DAMAGE. ACCIDENTS can happen to anyone & they aren't covered by the manufacturer's warranty. AND once this has expired, you can bet things will start to go wrong. With the average minimum Amiga repair coating £49.99 it DOES make sense for a one-off payment, to know you will never have ANY repair bills to pay for 2 or 3 YEARS. This Extended Warranty/Insurance policy must be taken out within 30 days of purchase. Full details on request.
COMPUTERS UPTO £600 IN VALUE - 2yrs £27.99 3yrs £42.99
COMPUTERS UPTO £999 IN VALUE - 2yrs £32.99 3yrs £67.99
Also available for printers & monitors etc. POA.

IT'S BACK! AMIGA 500 PLUS CARTOON CLASSICS

- > BUILT-IN 3.5" DISK DRIVE
 - > 1MEG RAM
 - > MOUSE
 - > TV MODULATOR
 - > WORKBENCH 2.04
 - PLUS
 - > LEMMINGO
 - > CAPTAIN PLANET
 - > THE SIMPSONS
 - > DELUXE PAINT 3
- 2Meg version add just £42.99

1.3 AMIGAS WITH 1MEG RAM. PLEASE PHONE FOR DETAILS

EXTERNAL DISK DRIVES

ROCLITE RF382av 3.5" EXTERNAL DRIVE £67.99
WITH ANTIVIRUS & ANTI CLICK FEATURES. RRP £79.99
OR WITH NEW XCOPY PRO £99.99
CUMANA CAX354 £56.99

MEMORY UPGRADES

AMIGA 500 & 500 PLUS	
A500 / 500+ 1/2meg upgrade without clock	£24.99
A500 / 500+ 1/2meg with clock & battery	£29.99
Just plugs in. No soldering. Warranty unaffected.	
A500+ 1MEG UPGRADE	£44.99
1.5 MEG A500 UPGRADE fully populated	£69.99
(Requires Gary chip removal & invalidates warranty)	
500/500+ EXTERNAL 2-MEG UPGRADE inc 2meg	£149.99
AMIGA 600	
AMIGA 600 1meg upgrade + clock (unpop)	£27.99
AMIGA 600 1meg upgrade + clock - now only	£44.99
Just plugs in. No soldering. Warranty unaffected.	
A600 PCMCIA 2 MEG 16BIT FAST RAM	£149.99
A600 PCMCIA C 4MEG 16BIT FAST RAM	£221.99
AMIGA 1200 FAST RAM CARDS	
A600 PCMCIA 2 MEG 16BIT FAST RAM	£149.99
A600 PCMCIA C 4MEG 16BIT FAST RAM	£221.99
MICROBOTICS 25MHz inc 0 meg 32bit fast ram	£129.99
MICROBOTICS 14MHz inc 1 meg 32bit fast ram	£199.99
MICROBOTICS 14MHz inc 2 meg 32bit fast ram	£225.99
MICROBOTICS 14MHz inc 4 meg 32bit fast ram	£359.99
These include 68881 co-processor on board & fit in the underside trapdoor. Warranty is unaffected. Add £50 for 25MHz version with 68882 co-processor.	
AMIGA 1500 & 2000 MEMORY CARDS	
DKB MEGACHIP BOARD FOR A1500/2000 inc 2meg	£184.99
GVP AMIGA 1500/2000 8 MEG CARD (unpop)	£99.99
1MEG x9 SIMMS	£32.99
4MEG x9 SIMMS	£129.99
GVP 4MEG x 32BIT SIMMS EACH	£169.99

PRINTERS

CITIZEN SWIFT 9COLOUR ONLY £184.99
9pin; 192cps draft, 48cps NLQ printing speed. 4 built-in fonts. Friction & tractor feeds. Paper park. Low cost ribbons. 2 year warranty. Epson & IBM Proprietary emulations. Low noise level. 32K RAM UPGRADE £13.99

CITIZEN SWIFT 240C COLOUR £284.99
CITIZEN SWIFT 240 MONO £249.99
24 pin; 240cps draft & 80 cps letter quality print speed. 9 fonts, 2 scalable fonts. Paper parking, push & pull tractor feed, friction feed. Epson LQ570, NEC P20 & IBM emulations. Ultra low noise level, + quiet mode for even lower noise. 2 year warranty. 128K RAM EXPANSION £32.99

CITIZEN SWIFT 200 SUPERB MODEL & ONLY £209.99
CITIZEN SWIFT 200 COLOUR £244.99
24 pin; 240cps draft & 80 cps letter quality print speed. Nine letter quality fonts, 2 scalable letter quality fonts. Paper parking, push & pull tractor feed, friction feed. Epson LQ570, NEC P20 & IBM Proprietary 24x6 emulations. 2 year warranty. 128K RAM EXPANSION £32.99

CITIZEN PRODOT 24 PROFESSIONAL PRINTER £259.99
24Pin 80 Column; 5 fonts; Epson, IBM & Nec emulations; 360x360 dpi graphics printing; 16K buffer. Colour version £299.99

CITIZEN PROJET INKJET LASER QUALITY PRINT £399.99
300dpi Laser quality 50 nozzle INK jet printer. Fast & very quiet. 360cps draft & 240 cps letter quality print speed. Three letter quality fonts + optional font cards. HP Deskjet Plus emulation. Optional 128k & 256k ram cards. 100 sheet automatic feeder. Ink cartridges - £13.99

BUDGET 4PPM LASER PRINTER - SEIKOSHA OP 104 £559.99
Four page per minute; HP Laserjet IIP emulation; 300x300 DPI; 1yr on site warranty. Postscript version with 2meg ram £849.99

FREE STARTER PACK WITH ALL CITIZEN PRINTERS. INCLUDES PRINTER CABLE; AMIGA DRIVER DISK & 250 (approx) SHEETS OF PAPER

MONITORS & TV MONITORS

PHILIPS CM8833mk2	COMMODORE 1084S	HI-RES 14" COLOUR MONITOR
£224.99	£199.99	£229.99
> 14" SCREEN	> 14" SCREEN	> 14" ANTIGLARE SCREEN
> STEREO SOUND	> STEREO SOUND	> 0.28mm DOT PITCH
> RGB & COMPOSITE INPUTS	> RGB & CVBS INPUTS	> 1024 x 768 PIXELS
> ON SITE WARRANTY	> SUPERB PICTURE	> ANALOGUE RGB INPUT
> LOTUS TURBO CHALLENGE	> DUST COVER £6.99	> TILT / SWIVEL BASE
> OFFICIAL UK MODEL	> CONNECTING LEAD £3.99	> Unsuitable for low res (15.6KHz) modes.
> DUST COVER £6.99	> OR BOTH FOR £8.99	
> CONNECTING LEAD £3.99		

COMMODORE 1960 HI RES 14" MULTISYNC COLOUR MONITOR.

WORKS IN ALL A1200 MODES inc low res. (15.6KHz modes)
£439.99 inc leads.
Productivity mode Adaptor £14.99 extra if required.

Compatible with ALL AMIGAs & PCs

HARD DRIVES

SUPERB GVP HARD DRIVES

GVP HD8 FOR A500 & 500+ - NO DRIVE	£184.99
GVP SERIES II HD8+ 42 Meg for A500	£329.99
GVP SERIES II HD8+ 80 Meg for A500	£419.99
GVP SERIES II HD8+ 120meg for A500 - now only	£499.99
GVP SERIES II HD8+ 210meg for A500 - now only	£669.99
The HD8 series II can accept either 1 or 2 or 4, 1 meg simms; OR two, 4 meg simms.	
GVP SERIES II HCB for A1500/2000 - NO DRIVE	£119.99
GVP SERIES II HCB + 42meg for A1500/2000	£309.99
GVP SERIES II HCB + 80meg for A1500/2000	£374.99
GVP SERIES II HCB + 120meg for A1500/2000 - now only	£449.99
GVP SERIES II HCB + 210meg for A1500/2000 - now only	£609.99
The HC 8 Series II can accept upto 8, 1meg x9 Simms in 2 meg steps.	
A530 42Meg Hard drive & 68030 Accelerator for A500	£719.99
A530 80Meg Hard drive & 68030 Accelerator for A500	£819.99
A530 120Meg Hard drive & 68030 Accelerator for A500	£899.99
A530 210Meg Hard drive & 68030 Accelerator for A500	£1049.99
The A530 Combo feature a 68030 40MHz cpu, 1 meg ram expandable to 8megs, 68882 maths co-processor socket, power supply, cooling fan, mini-expansion slot, SCSI hard disk controller & hard disk as specified above. The A530 run at 12MIPS compared to standard Amiga's 0.87MIPS.	
GVP 68882 MATHS CO-PROCESSOR KIT for A530 COMBO	£214.99
1MEG SIMMS FOR GVP DRIVES	£32.99
4MEG x9 SIMMS FOR GVP DRIVES	£129.99
4MEG 32BIT SIMMS FOR A530	£169.99
GVP IMPACT EXTERNAL TWIN 5 1/4" HARD DRIVE CASE	£174.99

COMMODORE A500 HARD DRIVE UPGRADES

A590 40 meg SCSI upgrade - easy to fit	£214.99
A590 120meg SCSI upgrade - easy to fit	£349.99
A590 MEMORY CHIPS	£32.99/MEG
All upgrades are easy to fit yourself, or we will fit for you for £15.00.	

ACCELERATORS & EMULATORS

PC CARDS & EMULATORS

KCS POWER PC CARD v4.5 FOR AMIGA 500 & 500 PLUS	£149.99
MS Dos4 if required	£34.99
KCS POWER PC EMULATOR CARD FOR AMIGA 600	£69.99
AMIGA 1500/2000 KCS ADAPTOR	£64.99
VORTEX AT ONCE PLUS 286 PC EMULATOR FOR A500	£219.99
GVP PC286 PC EMULATOR CARD FOR SERIES II HARD DRIVES	£189.99
GOLDEN GATE 386SX PC CARD FOR A1500/2000	£399.99
GOLDEN GATE 486SX PC CARD FOR A1500/2000	£749.99
OPTIONAL DRIVE CONTROLLER CHIP FOR GOLDEN GATE	£34.99

ACCELERATORS

BLIZZARD TURBO/ MEMORY BOARD FOR A500 /500+ £209.99
Clock doubled 68000cpu; 8meg ram capacity - upgradable from 1meg (2,3,4,5,6,8meg steps). Fully autoconfiguring. With only 1meg on board - gives 200% speed increase over standard Amiga. 2yr warranty.

GVP G-FORCE ACCELERATORS FOR A1500/2000
G-FORCE 030/25MHz others available - poa £479.99

FAST INTERNAL HARD DRIVES FOR YOUR AMIGA 600 & 1200.

20MEG PRICES FROM UNDER £120
* Prices include drive cable.
* Formatted ready to use.
* Easy to fit - installs in second - attach to internal drive bay bracket (screws included) & plug-in the cable - that's all there is to it.
* FITTING CHARGE £15.00

EXTENDED WARRANTIES - COVERS YOUR AMIGA & DRIVE - FROM £26.99 FOR 2 YEARS. 3 year cover also available.
*Fitting a hard drive invalidates Commodore's warranty - we highly recommend you take out an Extended Warranty which also covers accidental damage.

PRINTER & MONITOR LEADS

AMP1 1.8m PARALLEL PRINTER LEAD	£9.99
AMP2 3m PARALLEL PRINTER LEAD	£12.99
AMP3 5m PARALLEL PRINTER LEAD	£16.99
2 PIECE UNIVERSAL PLASTIC PRINTER STAND	£5.99
UNIVERSAL METAL PRINTER STAND & PAPER HOLDER	£10.99
LACROSS s/adhesive LABELS approx 3.5"x1.5" 1000 for	£7.99
CONTINUOUS 60gm PAPER 11"x9.46" box of 2000for	£21.99
RIBBON RE-INKING SPRAY - Jet black - saves time	£11.99
MONO RIBBONS for most Citizen, Panasonic, Star	£4.99
COLOUR RIBBONS - LC200/24-200 & SWIFT9/224/24/240	£15.99
CITIZEN PROJET INK CARTRIDGE (BLACK)	£13.99
TAILORED PVC PRINTER DUST COVERS	£6.99
For popular Citizen & Star printers - please state printer when ordering.	

MONITOR & TV/MONITOR LEADS

ALL FOR TVs WITH SCART SOCKET (Not for VCRs)	£13.99
incl Sony, Philips, Ferguson, Hitachi, Toshiba, Mitsubishi	
AL2 for Ferguson Mc01/Mc03/Mc05 with 8 pin Din socket	£12.99
AL4 for Hitachi/Granada sets with 7pin Din RGB input	£12.99
AL6 for Amstrad CPC464/6128 monitor (with no sound)	£12.99
AL6B for new Amstrad CPC stereo monitor	£13.99
AL7 for 1084s monitor with 8 pin Din socket	£14.99
AL7P for 1083/1084s/8833 with 9pin D socket	£14.99
AL11 with 9 pin D plug for multisync monitors	£12.99
AL12 with 15 pin 3row socket for multisync monitors	£13.99
AL13 with 15pin 3 row plug for multisync monitors	£13.99
FLICKER FIXER LEAD - 9 plug to 15way 3 row plug	£2.99
MODULATOR EXTENSION LEAD eliminates overhang	£10.99
DELUXE MONITOR STATION fits over Amiga 500 & 500+	£49.99
includes monitor/computer 1 piece PVC dust cover, mouse mat Has cut out for hard drive.	
MOUSE & JOYSTICK EXTENSION KIT FOR PLINTH 1 & 2.pair	£7.99
MONITOR TILT/SWIVEL BASE for upto 14" monitors or TVs	£10.99
HEAVY DUTY SWIVEL BASE FOR UPTO 17" TVs	£12.99

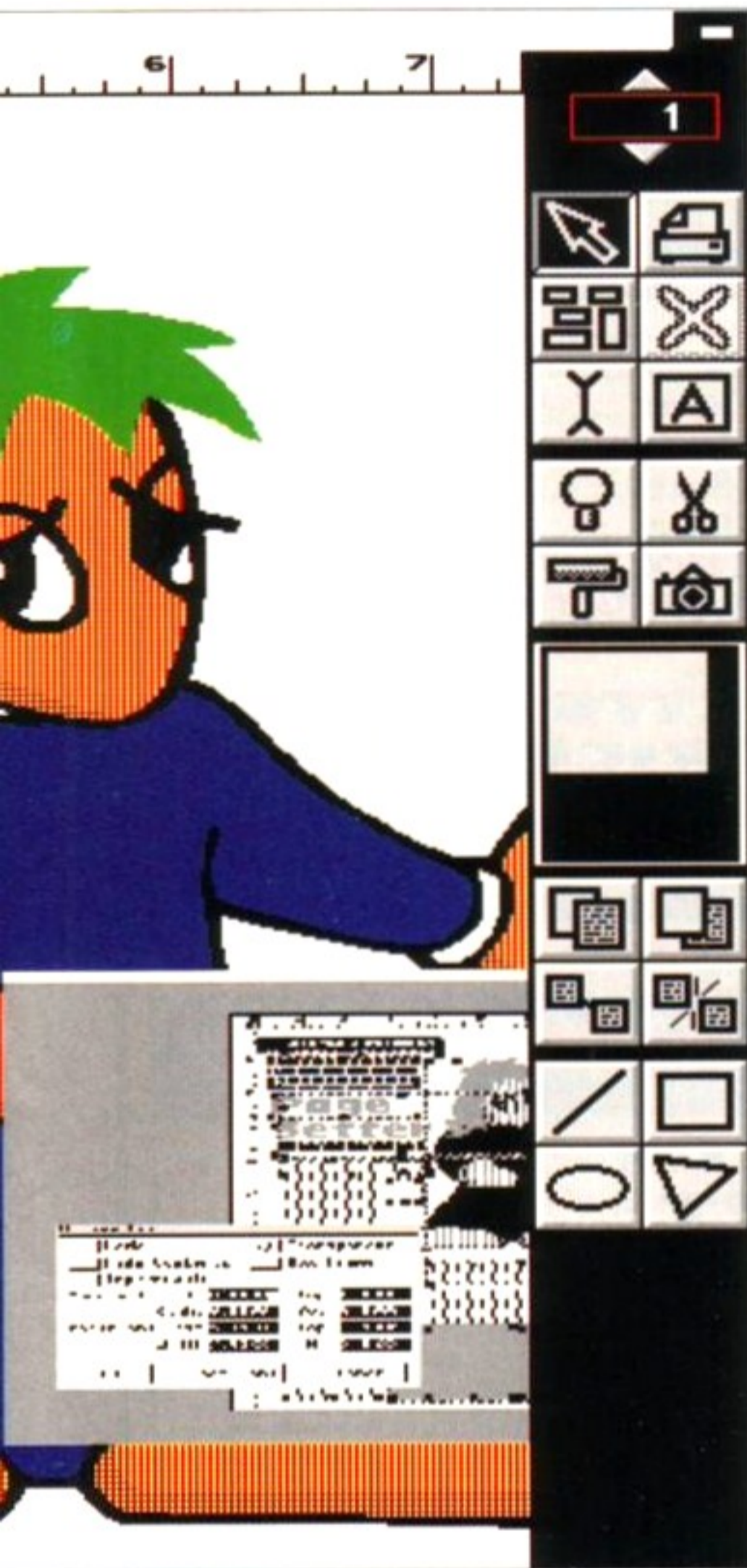
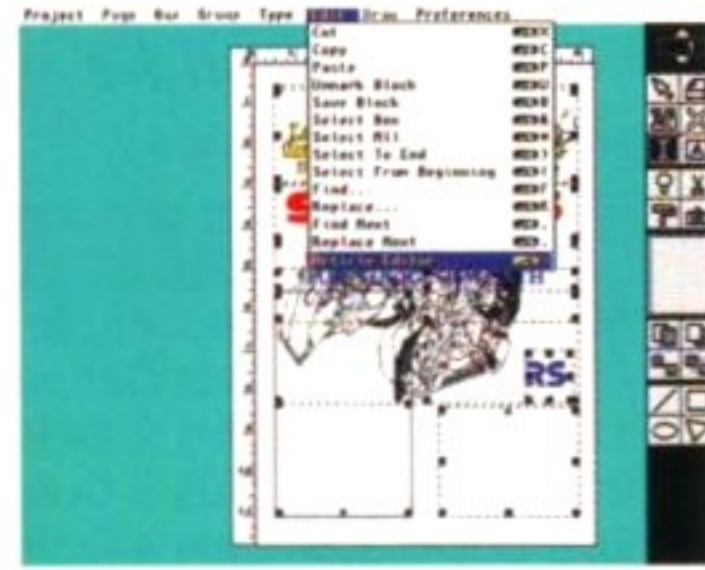
DTP MADE EASY

There are three different modules that make up the *PageSetter* system. These are all 'hot-linked' together, and they enable you to create pages without you having to use other programs.

If you just want to add some copy or text into your page layout, then all you have to do is open up the box that is to contain the text, and then select the Article Editor from *PageSetter*'s pull-down menus (as shown here).



The Article Editor looks and works just like a conventional text editor. Elaborate fonts are not used here, so text can just be typed in at full speed, and you don't have to wait for painful screen redraws. You can cut, copy and paste text with ease, and you can even load text files from other word processors. Once the text is complete, selecting 'Send Text Home' will send the text back to *PageSetter*.

Once the *PageSetter* screen pops back into view, the text you created in the Article Editor is flowed into the document automatically. If you're not entirely happy with the typeface, point size, leading or colour you've selected, then don't worry because this can be changed with ease.

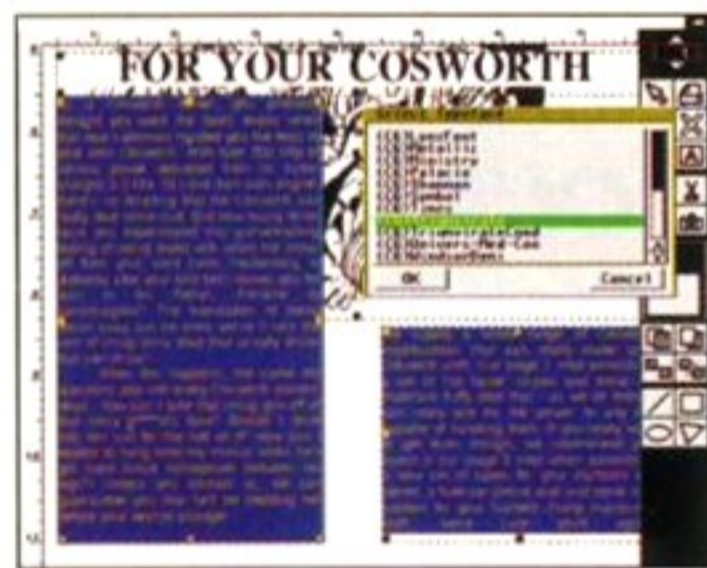

Existing pictures can be pulled directly into *PageSetter*. The Graphics Editor however, can come in handy if you need to create illustrations on the spot. Featuring the same sort of frontend as *DeluxePaint*, the Graphics Editor enables you to create illustrations in any resolution with up to 32 colours.

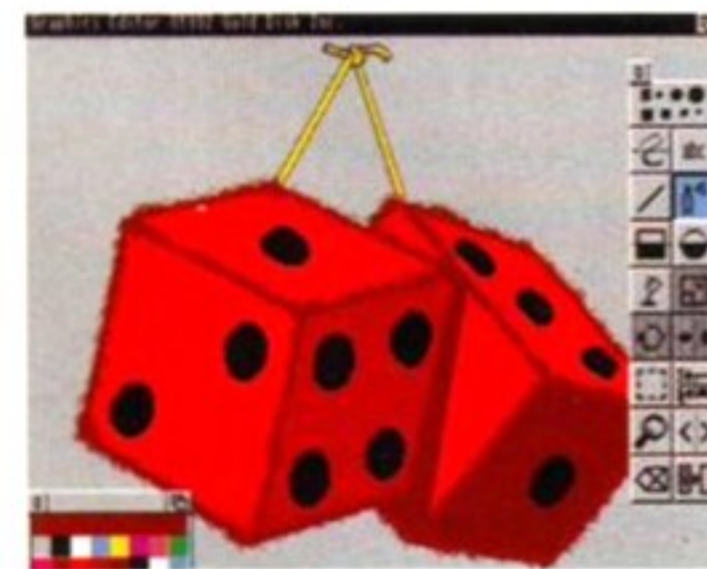

With text and graphics in place, our layout is now complete. It can now be printed to any preferences-supported printer, or even to a PostScript device. DTP has never been so easy, or cheap!



usual drawing tools you'd expect to find in a bitmap image editor. Support for all the usual Amiga screen resolutions and colour combinations is here, so you're not just restricted to the usual line art.

One annoying aspect of *PageSetter* (and indeed *ProPage*, for that matter) is that bitmapped images are not automatically scaled to the exact size of the box in which they will be contained. When you create an image in the Graphics Editor or pull in an existing image, you have to manually scale the picture yourself, which can be a rather hit-and-miss affair.

Both modules are 'hot linked' to the *PageSetter* layout program, so the files that you create are automatically pulled into *PageSetter* as soon as you've finished editing them. This sort of integration requires a lot of RAM - even on a 2Mb A1200 things get very tight, especially when using lots of different Compugraphic fonts and high-resolution colour pictures. If you want to get the very most from *PageSetter 3*, some extra RAM (and a hard disk if you can afford it) are definitely recommended. That's not to say that *PageSetter* isn't useable on a 1Mb machine - just don't expect to create anything particularly complex!

PageSetter 3's main rival has to be the Disc Company's *The Publisher* (AF43 - 92 per cent). Both are priced at exactly the same level and each has its own individual strengths and weaknesses. If layout power is paramount, and you're not too worried about colour support, then *The Publisher* is perhaps still a better bet. Although it doesn't have its own built-in text and graphic editors, it still offers far more typographical control, which many professionals will no doubt prefer.

For the rest of us, *PageSetter 3* is undoubtedly the program for the masses - it's cheap, it's powerful and it's very easy to use. Although it probably wouldn't be able to handle the sort of heavyweight DTP tasks that *The Publisher* eats for breakfast, the level of power has been perfectly balanced. Add to this *PageSetter 3*'s blindingly obvious ease of use and you've got a package that earns its *Format-Gold* award with flying colours.

PageSetter 3

- SPEED** ●●● All those colours, complex graphics and outline fonts can slow *PageSetter* down considerably.
- DOCUMENTATION** ●●● Although quite readable, the manual is rather sketchy in places.
- ACCESSIBILITY** ●●● Like its parent product *ProPage*, *PageSetter 3* is a joy to use.
- FEATURES** ●●●● With its built-in text and graphics editor, it's the most complete DTP program available.
- VALUE** ●●●● For the price of two games, you can have a fully featured DTP program.



must. Then again, perhaps it's a deliberate ploy to protect sales of *Professional Page*.

What makes this version such an advancement over previous incarnations, though, are the two extra modules which help to make it a more integrated, one-stop publishing system. The first of these is the Article Editor, which is basically a mini word processor based around Gold Disk's *Transcript*. Although text can be edited directly within your layouts, the Article Editor doesn't use fancy Compugraphic fonts, so text editing is considerably faster.

But the Article Editor isn't actually built into the program. Instead, it resides on disk until it's needed. Then, simply by defining a box and selecting 'Article Editor' from the pull-down menus, *PageSetter* automatically loads and runs it for you. You can then edit your text, load in an existing text file and even insert formatting commands which define type attributes (font name, tracking amount) that *PageSetter* will use when you return to the layout program. There are some type attributes that can only be defined from the article editor, tracking (the space between individual characters), for example.

Finally, there is the Graphics Editor, which - as its name suggests - enables you to modify and even create new images from scratch. Boasting a frontend that isn't too dissimilar to *DPaint*'s, the Graphics Editor offers all the

PUBLIC APOLOGY

1993 - we will start as we mean to go on. As ever, we will be offering highest quality goods at the best possible prices.

3.5" DSDD PLUS BANX STACKABLE BOX

50 DSDD 3.5" plus Banx Box.....	£32.00
100 DSDD 3.5" plus Banx Box.....	£46.00
150 DSDD 3.5" plus 2 Banx Boxes	£70.00
240 DSDD 3.5" plus 3 Banx Boxes	£108.00
320 DSDD 3.5" plus 4 Banx Boxes	£148.00
400 DSDD 3.5" plus 5 Banx Boxes	£180.00

BANX BOXES ARE STACKABLE, HORIZONTALLY AND VERTICALLY, LOCKABLE AND BEAUTIFULLY MADE

3.5" DSDD PLUS DELUXE BOXES

50 DSDD 3.5" plus Deluxe Box	£27.50
100 DSDD 3.5" plus Deluxe Box	£44.95
150 DSDD 3.5" plus 2 Deluxe Boxes	£57.00
200 DSDD 3.5" plus 2 Deluxe Boxes	£76.95
400 DSDD 3.5" plus 4 Deluxe Boxes	£145.00
500 DSDD 3.5" plus 5 Deluxe Boxes	£178.00

ALL DISKS CERTIFIED 100% ERROR FREE AND SUPPLIED WITH LABELS. BOXES ARE LOCKABLE ANTISTATIC WITH AMPLE DIVIDERS

BEAT THE NEW E.E.C. IMPOSED DISKETTE LEVIES DUE TO BE IMPLEMENTED FEB 92. PRICES MAY INCREASE BY UP TO 55%

LOOK

ULTIMATE A1200 PACK

The most comprehensive and best value pack ever.
HERE'S WHAT YOU GET

	RRP		
NEW A1200 COMPUTER.....	£399.99*	3.5 " Diskette Head Cleaner	£3.95
ZOOL PACKAGE WORTH	£127.92*	Tailor Made Dust Cover	£3.95
(Includes Zool, Striker, Pinball, Dreams, Transwrite).		Clip on Copy Holder	£6.95
100 'A' Grade 100% Certified 3.5" disks	£40.00*	TOTAL.....	£598.66
Banx Deluxe Stackable Box	£11.95*	OUR ULTIMATE PRICE.....	£439.95
Deluxe 8mm Mouse Mat.....	£3.95		

*When purchased separately

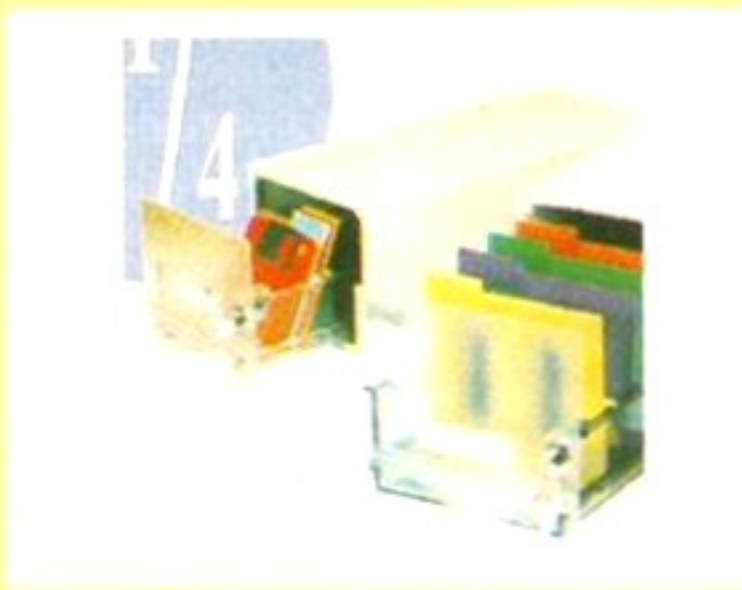

BANX stackable disk boxes

Exclusive to us, these disk storage boxes are superior to many we've seen costing more than twice as much. Beautifully constructed in best quality materials with a smooth-running drawer. Supplied with four colour-coded dividers and fittings to stack horizontally or vertically. Available in two sizes. The Dual Format version is also ideal for compact disks.

3.5" 80 + DISK CAPACITY £11.95
MULTI BUY DISCOUNTS
3-4 £8.95 EACH 5+ £8.50
DUAL FORMAT
180 5.25" disk capacity
or 130 3.5" disk capacity
£16.95

EXCLUSIVE!

READER OFFER - 100 HD 3.5" Disks PLUS BANX STACKABLE BOX for the incredible price of only £74.95

18 Crescent Way, Orpington, Kent BR6 9LS

***ALL COMPUTERS SPECIAL FREE SUPERFAST DELIVERY**

All orders subject to availability. Prices include VAT

M D OFFICE SUPPLIES

Free post & packing on orders over £20.00

Orders below add £2.95

TEL : 0689 861400

FAX : 0689 850628



For £150 16-bit sampling could be within your reach. But is it purely for professional musicians? **Andy Nuttall** finds out...

FROM TIME TO TIME a piece of software or hardware is released which looks so sexy, and the hype is so great, you begin to believe it. Then, when the product actually arrives on the shelves, and you part with your dosh, you realise that you have in fact been duped.

Clarity 16 is the perfect example. For months we've been promised budget 16-bit sampling for around £150, and that our Amiga will be lifted to musical heights previously reached only by expensive, dedicated hardware.

Now it's here, we find that yes, it is 16-bit, and you can sample at 44.1KHz, but what about a monitor facility to listen to your source while sampling? What about a user-friendly interface that displays all the information you need? Unfortunately, presumably due to the constraints of the Amiga's hardware, they seem to have been overlooked.

OK, you've got the gist of the review, but Clarity does have some good points. The software engine uses Intuition, Workbench's operating system, which most owners will be familiar with. Because of this, each utility that Clarity offers is given a different window which may be open or closed at any time. This modular approach enables you to decide what goes where on your screen.

All the usual editing functions are included such as cut, paste, zoom and loop; while others such as overlay/mix samples, normalise and pan are useful additions to the norm. Effects such as reverb, flange and chorus may be applied to your samples while they are held in memory, and they may also be applied in real-time to your sampling input.

A basic MIDI interface is built in, with IN and OUT ports, and some decent MIDI options are provided. These include stereo and mono sample dumps between Clarity and an external sampler. MIDI mapping is possible, supporting keyboards of up to seven octaves.

Unfortunately, it seems even these good points are not without fault. Due to hardware constraints, the interface doesn't multi-task. This means the VU meter and oscilloscope-style monitors will not work while Clarity is sampling or playing back samples, so in effect

The long-awaited Clarity 16 hardware, when it's packaged up in a sexy box with complementing ribbon cables. It looks great, but is it just mutton dressed as lamb?



Clarity 16

£149.95 ■ Microdeal ■ Stereo sampler

CLARITY 16 is available from **Microdeal** 0726 680020

The sequencer window can be used to string together a single track of samples.

you have to sample 'blind', and hope that your input doesn't clip or distort. Of course, you can monitor your input first, adjust the level, and then sample, but this is a tedious process which won't appeal to most musicians.

The window-style interface looks user-friendly, but in use it's tedious. If you have several windows open, control reverts back to the main command window after an operation such as filter. Because of this, the sample window must be reselected every time you want to work on it. This is most annoying, and must be put down to thoughtless programming.

Again due to hardware constraints, it's only possible for Clarity to play up to four sounds simultaneously – and that's when using an accelerated Amiga, like an A1200 or A3000. When using a normal Amiga it is possible to play one 16-bit stereo sample or two 16-bit mono samples. Obviously reducing the sample to 8-bit, or sampling at a lower rate will put less pressure on the Amiga's processor.

So how good is the sound quality? Not bad, but it's not CD-quality. It manages to match other 16-bit samplers and CD players in terms of range and sampling rate, but high-frequency noise is noticeable on playback. This may be filtered out using the low pass filter provided, but of course this reduces the dynamic range of the sample. Also, when the frequency is set to around 15KHz, the low pass filter has a tendency to destroy the sample altogether. On a good note, the stereo facility works well, and cross-over distortion is kept to a minimum.

Opening up the unit reveals a PCB with some impressive-looking custom chips, but poor soldering and a number of bodes suggests the unit was rushed. Also, more attention could have been given to the interface – the 'D'-connectors for the parallel and serial interfaces are difficult to remove from the Amiga. An input level attenuator wouldn't go amiss, either – as it is you need to use an input device with a volume control to avoid distortion.

Amiga musicians everywhere have been waiting for this release, and they're going to be let down. Clarity 16 promises the Earth, but ends up being just another flawed genius.

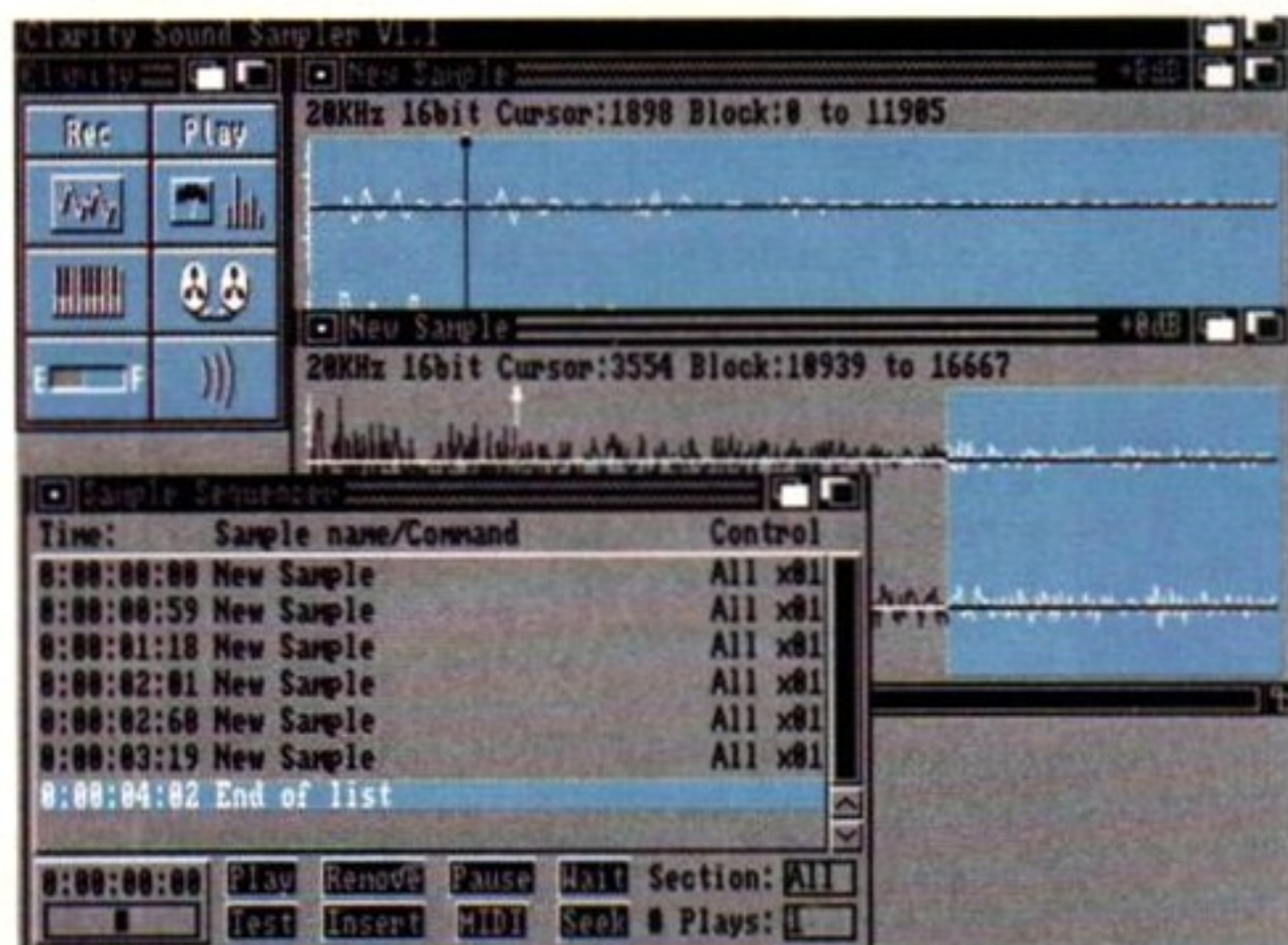

Clarity 16

SPEED ●●●
Complex samples are manipulated reasonably quickly, and disk access times are low.

DOCUMENTATION ●●●
A fairly flimsy manual which manages to describe sampling and MIDI reasonably well.

ACCESSIBILITY ●
A badly thought out interface, which is incredibly tedious to use for any length of time.

FEATURES ●●
16-bit samples; MIDI interface; poor build quality and naff user interface and noisy samples.

VALUE ●
Similar sound quality to StereoMaster, but four times the price and less friendly to use.

Verdict **41%**

ALL NEW
32-BIT
AMIGA



FREE
INDI
VALUE
ADDED

The latest, the ultimate, the best home computer available. 16.8 million colours, superfast processor, superb stereo sound, lightning speed – the all new Amiga 1200 has them all. Marvel at the ease with which the Amiga 1200 and its amazing 32-bit processing power devours the most demanding software. At this price the A1200 has no equal – forget the rest, it's definitely the best!

1200 STANDARD FEATURES

- 68020 Processor • PCMCIA Slot • 2Mb Chip RAM 3.5" Internal Floppy • AA Chipset • Built-in TV modulator • Alpha-numeric keypad • Free 12 Months At-Home Maintenance

INDI VALUE ADDED FREE

- 3 Superb Games • International Sports Challenge • The Cool Croc • Paradroid 90 • Zapsac and Zappo T-Shirt.

A1200HD Indi are now able to provide official Commodore recommended 60/80Meg Hard Drive versions of the A1200 with official installation disks and approved warranty. Ring for prices. Other dealers may not be offering approved A1200 HD product and are therefore infringing Commodore copyright and on-site warranty.

INDI PRICE £379.99

CUSTOMER CHARTER

INDI Direct Mail is original and very exciting. Before you buy mail order you must first be confident that you will receive the product you've ordered and that the supplier will still be there in the future, should you need them.

A mail order purchase from INDI is a safe and secure decision, and here's why.

INDI is a wholly owned subsidiary of a public company now in its tenth year of trading and specialising in the supply of computer products.

With a turnover approaching £30 million per annum, we have the resources and the purchasing power to offer you the best deals, deliver them next day nationwide and always be around when you need us.

SALES AND SUPPORT

The INDI sales team have been trained to take your order with the utmost care and efficiency. All stock offered for sale is held in stock, centrally at our group warehouse complex and is available for next day delivery, direct to your home or business. If at any time we are out of stock your money will not be banked until the product is available (a point worth checking should you feel tempted to purchase elsewhere).

General information regarding product is available from our sales team, however technical support is always on hand should you need assistance.

All prices quoted are inclusive of VAT.

AMIGA RECOMMENDED PERIPHERALS & ACCESSORIES



AMIGA 1084S/T COLOUR/STEREO MONITOR Commodore's original and best selling colour/ stereo monitor is fully compatible with all Amiga computers. This latest model now features the new 'Swivel' and 'Tilt' stand for total ease of use. Without doubt the best value for money monitor available. **INDI PRICE £189.99** If purchased with A600/A1200 **INDI PRICE £179.99**



ZAPPO EXTERNAL 3.5" DRIVE A high quality external 3.5" drive for use with A500/A500+ JA600/A1200. Exceptional value for money product. **INDI PRICE £44.99**



COMMODORE MPS 1270 INK JET PRINTER Commodore's own ink jet printer. Whisper quiet yet prints at an amazing 160CPS. Possibly the best value ink jet available on the market. Especially at this price!!! **INDI PRICE £99.99** (A500/A500+ JA600/A1200/C64 compatible)

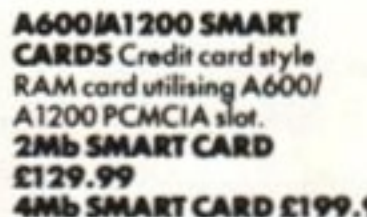

A600/A1200 SMART CARDS Credit card style RAM card utilising A600/A1200 PCMCIA slot. **2Mb SMART CARD £129.99** **4Mb SMART CARD £199.99** Comes with lifetime Guarantee.



ZAPPO 601 RAM UPGRADES (A600) **ZAPPO 601 NC-512K RAM Upgrade no clock £29.99** **ZAPPO 601 C-1Mb RAM Upgrade with clock £49.99**

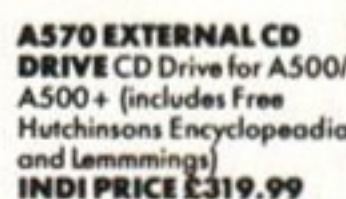

A570 EXTERNAL CD DRIVE CD Drive for A500/A500+ (includes Free Hutchinsons Encyclopaedia and Lemmings) **INDI PRICE £319.99**



MICROBOTICS MBX1200 FLOATING POINT AND 32-BIT WIDE MEMORY EXPANSION FOR THE NEW AMIGA 1200 The MBX1200 is offered to Amiga 1200 owners as a cost effective, high quality upgrade solution to provide a Motorola 68881/68882 floating point unit and to support the installation of up to eight megabytes of 32bit wide Amiga FastRAM. Speeds up FPU operations by as much as 55 times that of the native A1200. MBX1200 permits the A1200 user to realise the full potential of his system and software. **INDI PRICE Basic Co-Processor £199.99** **4 Meg £299.99** **8 Meg £399.99**



3 Top quality **JOYSTICKS** recommended for use with any Amiga product **PYTHON 1 RRP £14.99** **INDI PRICE £9.99** **MAVRICK** Arcade style/microswitched joystick **£12.99** **AVIATOR** Flight sim etc **£22.99**



PANASONIC KXP2180 9 pin colour dot matrix printer with free Wordworth (RRP £129.99) See facing page for full details) **£199.99**



PANASONIC KXP2123 24 pin colour dot matrix printer with free Wordworth (RRP £129.99) See facing page for full details. **£239.99**



PANASONIC KXP4410 Laser Printer with free Wordworth (RRP £129.99) See facing page for full details. **INDI PRICE £499.99**



PANASONIC KXP4430 Laser Printer with free Wordworth (RRP £129.99) See facing page for full details. **INDI PRICE £799.99**



MULTISTART II ROMSHARER + 1.3 ROM Enables use of Kickstart V2.0 and V1.3 ROMs. Giving access to older software that doesn't work under new operating system. Easy to install. Compatible with A500/A500+ JA600 **INDI PRICE £44.99**



ROCTEC GENLOCK Cost effective video overlay for all Amigas. **INDI PRICE £69.99**



INDI TELESales

Tel 0606 43860 Fax 0606 43825

AMIGA A600 THE WILD, THE WEIRD AND THE WICKED PACK

DESPATCH

All orders received by 6pm Monday to Friday are despatched that day for next day delivery using our national carrier – Securicor. (UK Mainland only). Saturday deliveries are available at a small surcharge. If you are out when we deliver a card will be left at your home giving you a contact telephone number to arrange a convenient re-delivery.

Delivery queries can be resolved immediately using our on-line computer.

All orders are despatched on a next working day delivery basis. Cheque orders are despatched immediately on cheque clearance, usually 5 working days from receipt. A delivery charge of £5.00 is made per item unless otherwise stated.

WE ALSO ACCEPT B.F.P.O. ORDERS (DUTY FREE). CARRIAGE CHARGED AT UK POSTAL RATES.



12 MONTHS AT HOME SERVICE

- Zapsac Carry Case
- Zappo T-Shirt

FREE
INDI
VALUE
ADDED

INDI PRICE £319.99

Once again Commodore have put together a winning theme pack to complement the already popular Amiga A600. The Wild, the Weird and the Wicked Pack is an ideal starter pack containing a considered mix of software making the most of the Amiga's amazing capabilities.

To make this pack a perfect gift INDI have added a further four award winning games and a staggering list of valuable extras at amazing prices.

PACK AS STANDARD CONTAINS

- Amiga A600 single drive
- Built in TV Modulator
- 1Mb memory
- Push Over • Silly Putty
- Grand Prix • Deluxe Paint II
- Mouse and Manuals

INDI VALUE ADDED

- Micro Switch Joystick
- Lockable Disk Box
- Disk Wallet
- 10 Blank Disks
- Kick off 2 • Pipemania
- Space Ace • Populous
- Zapsac Carry Case
- Zappo T-shirt

A600 HD EPIC PACK

Pack includes Epic, Rome, Myth, Trivial Pursuits, Amiga Text, DeluxePaint III. **1.5Mb RAM, 20Mb HARD DISK** **INDI A600 VALUE ADDED PACK (As Wild, Weird, Wicked)**

INDI PRICE £419.99

We researched the colour printer market in great depth to find a colour printer good enough to cope with Amiga's powerful graphic output, yet at an affordable price. We found the perfect printer in the Panasonic KX-P2180 + KX-P2123 quiet printers.

We then considered that if you were going to buy a Panasonic printer, you would probably need a quality word processing package to use with it. We found that too, in 'Wordworth', yet at a retail price of £129.99 we thought that might be a little too expensive on top of your printer purchase! So together with Panasonic we decided to give a copy of 'Wordworth' free with every Panasonic printer. How's that for added value?

Panasonic

KX-P2180



*WORDSWORTH COMPLETELY FREE! WITH PANASONIC

QUIET PRINTERS The writers choice. The ultimate word processor for AMIGA computers. Wordworth is undoubtedly the ultimate word/document processor for the full range of AMIGA computers. The graphical nature of WORDSWORTH makes producing documents faster and easier, with the enhanced printing fonts (including full Panasonic KX P2180 and KX P2123 colour printing support), Collins spell checker and Thesaurus, no other word processor comes close. "Without doubt this is one of the best document processors for the AMIGA. Today." (Amiga Format).

NORMAL RRP £129.99 inc. vat

INDI PRICE

£199.99

The new Panasonic KX-P2180 9 pin quiet colour printer. Produces crisp clear text in mono or in 7 glorious colours with new quiet technology. The new KX-P2180 is typically 15dBA quieter in operation, than the competition.

- **Fast Printing Speeds** 192CPS Draft and 38 CPS NLQ
- **Colour Printing** 7 colour palette (blue, red, green, yellow, violet, magenta and black)
- **QuietPrinting** Super quiet 45-48dBA sound level (most matrix printers are typically in excess of 60dBA)
- **6 Resident Fonts** Over 6,100 type styles using Courier Prestige, Bold PS, Roman, Script and Sans Serif Fonts
- **3 Paper Paths** Paper handling from bottom, top and rear for total flexibility
- **1 Year Warranty** for total peace of mind.

Panasonic

KX-P2123



INDI PRICE

£239.99

The new high performance Panasonic KX-P2123 24 pin. Quiet colour printer offers leading edge quiet printing technology at an affordable price.

- **Fast Printing Speeds** 192 CPS draft, 64 CPS LQ and 32 CP SLQ.
- **Colour Printing** 7 colour palette (blue, red, green, yellow, violet, magenta and black)
- **QuietPrinting** Super quiet 43.5-46kBA sound level (most matrix printers are typically in excess of 60dBA)
- **7 Resident Fonts** Over 152,000 type styles using Super LQ, Courier Prestige, Bold PS, Roman, Script and Sans Serif Fonts
- **24 PIN Diamond Printhead** High performance and high quality output
- **1 Year Warranty** for total peace of mind.

Panasonic LASER PRINTERS

KXP-4410 LASER PRINTER



WORDSWORTH COMPLETELY FREE!
WITH PANASONIC LASER PRINTERS
The writers' choice. The ultimate word processor for AMIGA computers.
NORMAL RRP £129.99 inc. VAT

KXP-4430 LASER PRINTER



Once again Indi have joined together with Panasonic to offer all Amiga owners the most outstanding Laser Printer offer ever. We are now able to offer high quality, professional laser printing at very affordable prices. We are also giving away a free copy of Wordworth with every Panasonic Laser Printer purchased (RRP £129.99). Whether you're looking for a laser printer to handle word processing, DTP, presentation or complex graphics applications - the Panasonic range offers you the power to meet your requirements.

KXP-4410

- 5 pages per minute
- 28 resident fonts
- Optional 2nd input bin (total printer capacity 2x200 sheets)
- Low running costs
- Parallel interface
- Optional memory expansion to 4.5Mb

(0.5Mb as standard)
• HP Laserjet II Emulation
RRP £992.00

INDI PRICE

£499.99

inc. VAT

WORDSWORTH COMPLETELY FREE
WITH LASER PRINTERS

KXP-4430

- Satinprint (optimum resolution technology)*
- 5 pages per minute
- HP Laserjet III Emulation, PCL 5
- 8 scalable fonts & 28 bitmap functions
- Optional 2nd input bin (total printer capacity 2x200 sheets)
- Optional memory expansion to 5.0Mb (1Mb as standard)

RRP £1286.00

INDI PRICE

£799.99

inc. VAT

WORDSWORTH COMPLETELY FREE
WITH LASER PRINTERS

*[Satinprinters use optimum resolution technology to produce truly outstanding print quality. This software technique smooths away traditional jagged edges on curved characters and lines by varying the printed dot size and position].

Panasonic PRINTER ACCESSORIES



1) PANASONIC AUTOMATIC SHEET FEEDER
Automatic Sheet Feeder for KXP2180/KXP2123 holds 80 A4 sheets. **INDI PRICE £89.99**

2) PRINTER DUST COVER
Specially tailored quality dust cover for Panasonic KXP2180/KXP2123 printer. **INDI PRICE £8.99**

3) PRINTER STAND
2 piece printer stand. **INDI PRICE £9.99**

4) PAPER PACK
500 sheets quality A4 paper. **INDI PRICE £9.99**

5) PARALLEL PRINTER CABLE
To be used when connecting Amiga to Panasonic Printer. **INDI PRICE £8.99** (£5.99 if purchased with printer)

6) PANASONIC COLOUR RIBBON
Colour ribbon for KXP2180/KXP2123. **INDI PRICE £18.99**

7) PANASONIC BLACK RIBBON
Black ribbon for KXP2180/KXP2123. **INDI PRICE £9.99**

SAVE ££££'s ON THE FOLLOWING
ACCESSORY PACKS

PACK 1
PANASONIC COLOUR RIBBON PACK
Contains 6 colour ribbons for KXP2180/KXP2123. RRP £119.99 **INDI PRICE £89.99** SAVE £30.00!!!

PACK 2
PANASONIC RIBBON PACK
Contains 2 black and 4 colour ribbons for KXP2180/KXP2123. RRP £99.99 **INDI PRICE £69.99** SAVE £30.00!!!

PACK 3
PANASONIC DELUXE ACCESSORY PACK
Contents = Automatic Sheet Feeder, 2x black ribbons, 2x colour ribbons, 1x dust cover, 2 piece printer stand. RRP £169.99 **INDI PRICE £139.99** SAVE £30.00!!!

Add £2.50 carriage to all printer accessories or combinations thereof.



COMMODORE AMIGA CDTV THE MULTIMEDIA-COMPUTER

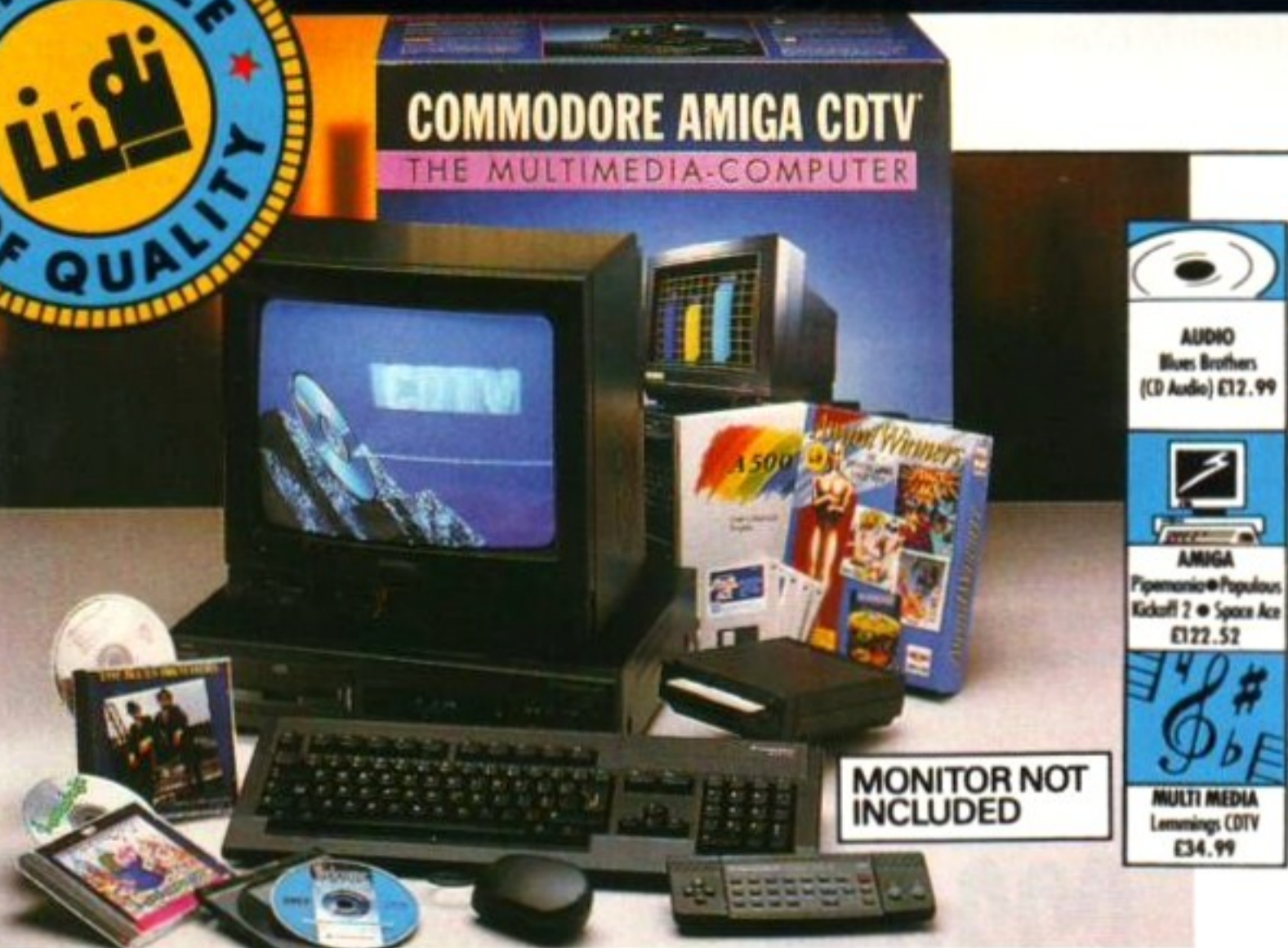

MONITOR NOT INCLUDED

- AUDIO Blues Brothers (CD Audio) £12.99
- AMIGA Pipemania+Populous Kickoff 2 + Space Ace £122.52
- MULTI MEDIA Lemmings CDTV £34.99

ENTERTAINMENT SYSTEM

The problem with any new product is that it always takes time for everyone to realise its full potential. CDTV is no exception and in our opinion everything we have read does a pretty poor job of explaining just what CDTV can do and why it is so exciting.

THE INDI GUIDE TO CDTV

IT'S A CD PLAYER - Yes, it will play all your Primal Scream, Pavarotti, Pink Floyd and any other CD you care to mention in superb high quality stereo, with remote infra red control.

IT'S AN AMIGA - Plug in the keyboard, switch on the external disk drive and the colossal range of inexpensive Amiga software can be used on your CDTV.

IT'S A MULTIMEDIA SYSTEM - Just imagine, stereo sound, images and text all on screen. It asks a question, you respond, it responds - truly interactive! Each CD disc holds hundreds of megabytes of data with instant optical access. The whole of

Hutchinson's Encyclopedia fits onto 1 disc. This interactive system is a unique aid for Education, Business or Leisure.

The future is here!

PACK CONTENTS AS STANDARD • Amiga CDTV Player • CDTV keyboard • CDTV 1411 3.5" Disc Drive • CDTV Infra red remote controller • CDTV wired mouse • CDTV Welcome Disc • Manuals • Fred Fish CDTV

INDI VALUE ADDED FREE • Lemmings CDTV (£34.99) • Blues Brothers (£12.99) • Pipemania, Populous, Kickoff 2, Space Ace (£122.52)

INDI PRICE £469.99

CDTV CONNECTS DIRECTLY TO YOUR TV SET

AMIGA CDTV SOFTWARE

ARTS AND LEISURE

- Advanced Military Systems £29.99
- Women in Motion £29.99
- Guinness Disc of Records £34.99
- Animals in Motion £29.99
- Connoisseur Fine Arts £34.99
- Fruits & Vegetables £34.99
- Trees & Shrubs £34.99
- Garden Plants £34.99
- Indoor Plants £34.99

EDUCATION

- Fun School - Under 5's £24.99
- A Long Hard Day at the Ranch £34.99
- A Bun for Barney £29.99
- Cinderella £39.99
- Fun School for 5 to 7 £24.99
- Fun School for over 7's £24.99
- Heather Hits Her First Home Run £34.99
- LTV-English as a 2nd Language £34.99

- Mind Run £29.99
- Mud Puddle £34.99
- My Paint £29.99
- North Polar Expedition £49.99
- Paper Bag Princess £34.99
- Scary Poems for Rotten Kids £39.99
- Tale of Benjamin Bunny £39.99
- Tale of Peter Rabbit £39.99
- Thomas' Snowsuit £34.99
- Moving Gives Me Stomach Ache £34.99
- Barney Bear Goes Camping £29.99
- Asterix English for French I £34.99
- Japan World (PAL) £49.99
- NASA, the 25th Year £19.99
- Fractal Universe £34.99

ENTERTAINMENT

- Battlechess £39.99
- Battle Storm £29.99

prices include carriage

- All Dogs to Heaven: Electric Crayon £34.99
- Ultimate Basketball £29.99
- Classic Board Games £34.99
- Dinosaurs for Hire £14.99
- Hound of the Baskervilles £29.99
- Psycho Killer £29.99
- Sherlock Holmes, Consulting Detective £39.99
- Sim City £29.99
- Trivial Pursuit (PAL) £49.99
- Wrath of the Demon £29.99
- Team Yankee £34.99
- Raffles £34.99
- Prehistorik £34.99
- Snoopy (PAL) £34.99
- Town with No Name £29.99
- Lemmings £34.99
- European Space Simulator £34.99
- Fantastic Voyage £34.99

- Global Chaos £29.99
 - Turrican II £29.99
 - Guy Spy £29.99
 - Cover Girl Poker £24.99
- MUSIC
- Music Maker £34.99
 - Remix £29.99
 - Karaoke Fun Hits I £14.99
 - Voicemaster + Microphone £39.99
 - Voice FX £19.99
- REFERENCE
- American Heritage Dictionary £49.99
 - Complete Works of Shakespeare £29.99
 - Illustrated Holy Bible £29.99
 - New Basics Electronic Cookbook £39.99
 - Timetable of Business £39.99
 - Timetable of Science £39.99
 - World Vista Atlas £54.99
 - Dr. Wellman £54.99

AMIGA CDTV ACCESSORIES



THE BRICK-ETTE Just plug in the Brick-ette and use any wired Amiga compatible joystick, mouse or trackball device on the Commodore CDTV. The built-in 8 bit Micro Processor gives the Brick-ette big smarts in a tiny package and makes it easy to use just plug into the remote port and it is ready to go with real time mouse or joystick movement

on your CDTV. No loading of driver programs or software. No switches for mouse or joystick. Special settings (with mouse) allow you to blast away with three rapid fire modes & dual fire buttons. Comes complete with Python Micro Switched Joystick.

INDI EXCLUSIVE £49.99

With two Joysticks £59.99



If you are thinking of buying CDTV or already own one you'll be pleased to know that INDI stock all CDTV accessories and software that are available from manufacturers. We believe in CDTV and we therefore continue to support this exciting product. You will always have a source of product for your CDTV from INDI.

- L to R: CDTV Encore SCSI Controller+Internal Mount Kit £109.99
- CDTV Internal Genlock £149.99
- Black 1084S Colour Stereo Monitor £189.99 (When purchased with CDTV Multi-Media Pack) £179.99
- CDTV Remote Mouse £49.99
- Scart TV/Monitor Lead (inc. Stereo Phono Lead) £14.99
- Megachip - 1Mb Upgrade ChipRAM Upgrade for CDTV £159.99
- CDTV External 3.5" Floppy Drive £49.99

AMIGA CDTV EXTERNAL HARD DISK DRIVE

You've got the CDTV, you've got the keyboard and floppy disk drive - for a total computer solution all that's needed is an ultra-fast hard disk drive.

The CDTV-HD unit boasts a massive 65Mb of hard disk storage with lightning fast access times through its SCSI interface. The unit comes complete with Workbench 1.3 and all necessary cables.

INDI PRICE



£269.99



BLACK 1084S MONITOR

At last the CDTV Monitor you have been waiting for. The original and best selling colour/stereo monitor from Commodore is now available in black to complement your CDTV.

INDI PRICE £189.99

(or £179.99 when purchased with CDTV Multi-Media pack).

SAVE £££'s on this offer

PROFESSIONAL AMIGA



EXCLUSIVE!

The A1500 is the ultimate home computer for the whole family and is designed to cover every computing requirement. INDI are able to offer you exclusive deals on this outstanding product in various configurations and bundles. All configurations come complete with the following software and accessories:-

FEATURES:

- Fully functional keyboard with numeric pad separate from CPU
- Includes 2 x 3 1/2" disk drives as standard with 5 1/4" Disk Bay.
- Integral memory and card expansion capabilities (most cost effective expansion route)
- Work bench 2.00 and Kickstart 2.04.

CONTENTS:

- Keyboard, mouse, reference manual, Puzznic, Toki, Elf (Games), D Paint III (Graphics Package), Home Accounts, The Works (Platinum edition: Wordpro, Spreadsheet, Database) Joystick

AMIGA A1500 FEATURED (see photograph above) ● 52 Mb SCSI Hard Disk ● Pack now includes 1084ST Monitor & Panasonic KX-P2123 24 pin colour printer.

INCLUDED FREE Amiga Vision and Wordworth Worth £229.99

Other 1500 configs available at very competitive prices. Phone for details.

£1159.99

24 BIT GRAPHIC SYSTEM



OPAL VISION 24 BIT GRAPHIC SYSTEM FOR THE AMIGA 1500/2000/3000/4000. If you have an Amiga (1500/2000/3000/4000) you must have OpalVision with the ability to turn your system into a tailor-made 24 bit workstation, complete with Genlock, Frame Grabber, Chroma Key, Flicker Fixer, Pip, True 24 bit Double Buffered Display, Video Switcher, Broadcast Resolution and of course the unique DVEs, the Opal is quite simply the only choice for any 24 bit all rounder who needs a system that will grow with your imagination and needs. Quite simply, it's a spectacular product. Contents: Opal Board, Opal Paint - 24 bit graphic creation tool, Opal presents - powerful presentation package, Opal Vision Hotkey - controls and manages OpalVision and Amiga Graphics, Opal Animate - animation software package, King of Karate - the world's first 24 bit graphics computer game. **INDI PRICE £599.00**

COMMODORE 1960 MULTI-SYNC MONITOR A 14" high resolution monitor for use with A1500/A2000/A3000/A4000. **INDI PRICE £369.99 OR £351.99** IF PURCHASED WITH A3000/A4000.

Note: Monitor is not included with any of these systems.

AMIGA 3000 25/52Mb The Amiga 3000 features the powerful Motorola 68030 processor running at 25Mhz. Complete with 52Mb SCSI Hard Drive (Single drive with no HD available) and 2Mb system RAM (6Mb Option Available). **FREE AMIGA VISION SOFTWARE. INDI PRICE £1229.99**

AMIGA 3000 - PC SYSTEM (386SX-25) The Amiga and PC hard drive system offering high performance PC386SX-25Mhz industry standard computing and the true multi-tasking performance of the Amiga, all in one box. Run the PC or the Amiga and transfer files between both operating systems. In addition to the standard Amiga 3000 specification, the Amiga 3000-PC system features 386SX processor running at 25Mhz with 1Mb of PC memory and DOS 5. **INDI PRICE £1449.99**

NEW! AMIGA 4000 040/120Mb The new flagship Amiga featuring the new AGA (AA) Graphics chip set with ultra high resolution and a palette of 16.8 million colours. The heart of the Amiga 4000 is the new Motorola 68040 (Not EC Chip) processor running at a breathe taking 25Mhz. Complete with 120Mb hard drive and 6Mb of 32-Bit RAM (Additional Memory available). **INDI PRICE £2095.99**



BODEGA BAY SYSTEM

Expansion System. (Turns your A500/A500+ into A1500). The Bodega Bay fits into the side expansion slot of your A500/ A500+ and provides 4 x 2000 style expansion slots. The Bodega Bay also has enough space for two half height 5.25" drives and one

3.5" drive. Comes complete with a high capacity internal power supply and cooling fan. **INDI PRICE ONLY £79.99** (While stocks last)

SOUND/VISION/ANIMATION ROMBO PRODUCTS NOW AVAILABLE FROM INDI

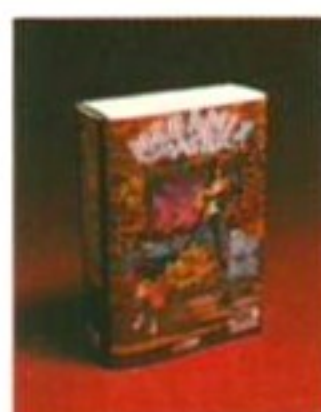

MEGAMIX is a low cost, high spec digital effects cartridge that plugs into the printer port of your Amiga. This allows you to sample or record stereo sound from almost any musical source. Special effects can be added in real time, perfect for the up and coming singer/musician/producer who wants that professional sound at home. You will find Megamix masters performance and its ease of use is unrivalled, just plug in and go...

INDI PRICE £29.99



VIDI AMIGA 12 is the ultimate low cost colour digitiser for your Amiga. There are no filters and no separate RGB Splitter. Colour images can be captured in less than a second, mono images are grabbed in real time. No other image capture system offers this level of specification for the price.

'The best value full colour digitiser on the market' **INDI PRICE £75.99**



TAKE 2 is a must for computer artists and enthusiasts of any age. It will cater for both amateur and professional applications. So get the most out of your computer and open up your imagination to Take 2. As used in Rolf Harris Cartoon Club.

INDI PRICE £37.99



AFTER SALES AND SPECIALIST SERVICE

All products are guaranteed for 12 months. Some products carry a 12 month at home service/repair guarantee (where indicated). In the unlikely event that any product purchased from INDI arrives at your home faulty, we will collect from your home and replace the product completely free of charge. If you own an AMIGA 1500 or 3000 and would like to expand its hard disk or memory capability or add any other peripheral INDI can offer you a complete door to door configuration service together with an additional 12 months Back to INDI warranty. Why not ask for a quote?

Products advertised represent a small sample of our instock range. A complete price list is available on request.

All products purchased come with a complete list of all products available from INDI with special customer loyalty offers.

AS PART OF OUR POLICY OF CONTINUAL PRODUCT DEVELOPMENT AND REFINEMENT, WE RESERVE THE RIGHT TO CHANGE SPECIFICATIONS OF PRODUCTS ADVERTISED. PLEASE CONFIRM CURRENT SPECIFICATION AT THE TIME OF ORDERING.

PRICES ARE VALID FOR MONTH OF PUBLICATION ONLY

HOW TO ORDER

BY POST — simply fill in the coupon below.
BY PHONE — ring 0606 43860 where your call will be answered by one of our INDI sales team. After 6.00pm each day your call will be answered by answerphone. If you would like to place an order have all details at hand including Credit Card. The message will guide you through your order.

SEND YOUR ORDER TO:
INDI DIRECT MAIL
FIRST FLOOR OFFICES,
85 WITTON STREET,
NORTHWICH AF 0293
CHESHIRE CW9 5DW

Please send.....
Price..... + Delivery
I enclose cheque/PO for £.....
or charge my Access/Visa No.

Expiry date /
Signature.....
Send to Name.....
Address.....
Daytime Tel.....
Postcode.....

TEL: 0606 43860 • FAX: 0606 43825

ON PAPER, THIS reads like a dream come true: Epson have updated their GT-6000 scanner (AF38 - 98 per cent) and reduced the price. This in itself should be enough to get Amiga artists or desktop-publishing fans reaching for their cheque books - but that's not the end of the story. The new scanner has a transparency adaptor and ASDG, being the enterprising company that they are, have included support for this desirable piece of kit in their new driver software. And the entire scanner/tranny, unit/software package can be had for a price that would previously only have bought you the scanner itself. Too good to be true? Let's take a look...

The software interface is the now-familiar *Art Department Professional* one, and the scanner can be driven from within *AdPro*. For users who don't have this in their software library, don't worry because a standalone version is included. The simple push-button front end is easy-to-use, and the intuitive layout and labelling of gadgets means that you can just plug in and start scanning, with minimum reference to the perfectly adequate manual.

The scanner connects to the Amiga via the parallel port, using an adaptor card on the scanner-unit itself, which replaces the usual SCSI ports. It's a pity that ASDG have decided not to support the unit via SCSI, but that's life. It has a hardware resolution of 300 x 600dpi, but firmware (software built into the hardware) interpolation takes this to an output of between 50 and 1200dpi. It's because the

Graphics users have long desired an affordable method of scanning transparencies into the Amiga. Now ASDG have come to the rescue with a driver for Epson's GT-6500 scanner that supports a transparency adaptor. Can it cut the mustard? **Marcus Dyson** investigates...

Yes, it is big and impressive, but it won't cost you an arm and a leg. The Epson GT-6500 is the cheapest way to get high-quality 24-bit images into your Amiga. Put the optional transparency unit on top of this and you have the only way of scanning colour slides into your Amiga.

EPSON GT-6500 is available from **HB Marketing** on **0753 686000**.
GT-6500: £799
Transparency unit: £545
Driver software: £110.60

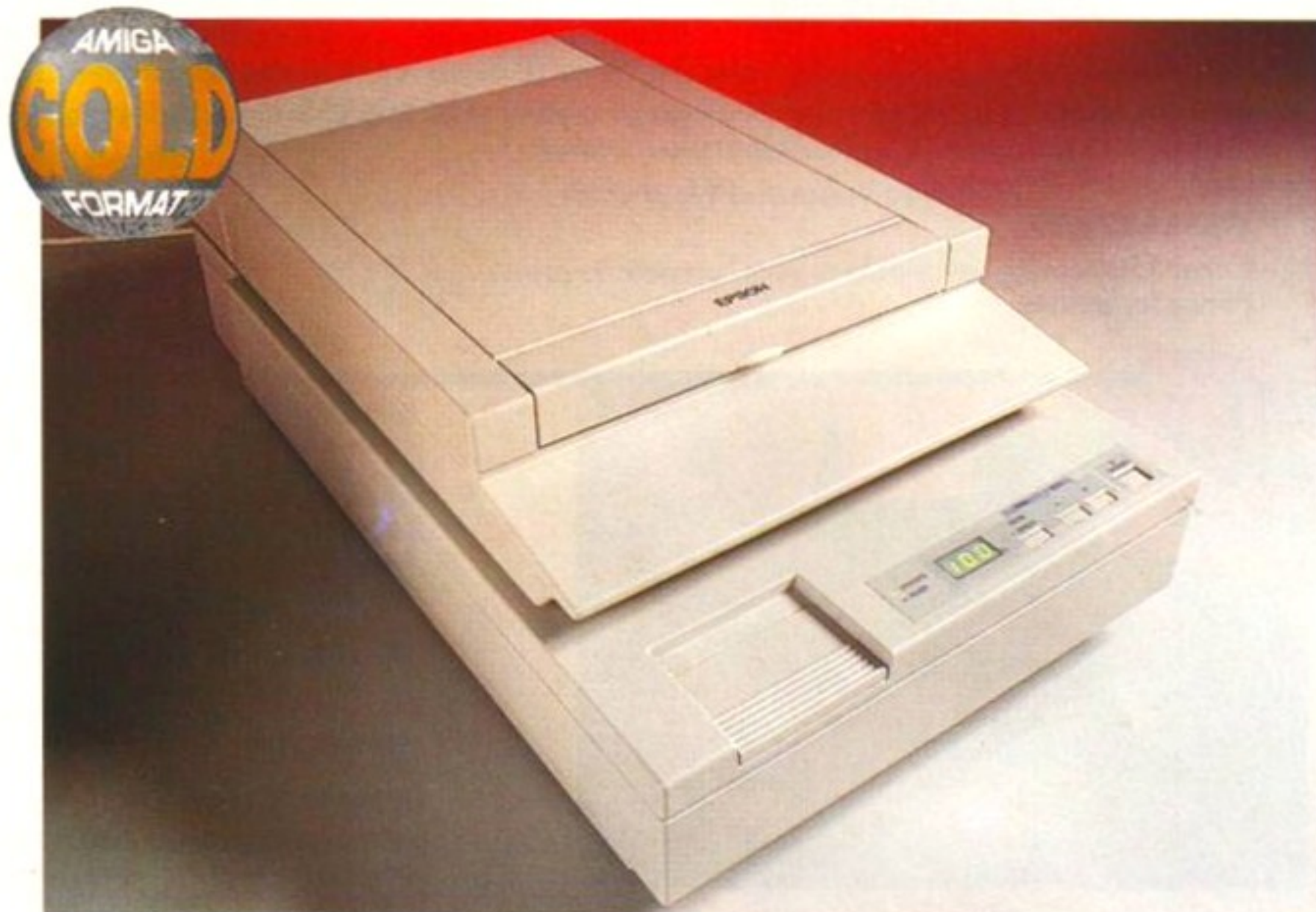

Epson GT-6500

HAND-HELD COLOUR scanners for the Amiga are not common things, though one wonders why not. The technology is nothing new, and the need for them is definitely there. Imagine being able to get any picture you see in a magazine, book or catalogue and capture it as an IFF file for immediate use in *DeluxePaint*, or any other paint package. Let's face it, whether you can draw or not, it would be a god-send.

Power Computing, whose mono hand-held scanner beats off all competition in our opinion (AF36 - 90 per cent), have come to the rescue. The PowerScan3 looks much like any other hand-held, but beneath the stylish plastic exterior lies something unique in the Amiga hardware field: a colour scanning head. But can this piece of kit possibly give results as good as Power's mono hand-held?

The unit interfaces to the Amiga via a Zorro slot in the 'large case' machines, or via the edge connector on the left of the A500/500 Plus. A600/1200 owners are left out in the cold though, at least for the time being. A pity really, because if it could be connected to the serial port it could be used with all Amigas.

The method of actually connecting the scanning hardware to the machine varies depending on which type of Amiga you are using. Despite this it is still fairly straightforward. A500 owners simply plug a metal box into the left side of their machine, and then plug the scanner into the box. Owners of larger machines have to open them up, stick a card in

Colour scanners have always remained in a price range attainable only by the wealthy bourgeoisie. But Power Computing's new hand-held scanner promises to bring colour to the proletariat. **Marcus Dyson** takes a look to see if this could spark a desktop colour revolution...

The Power colour scanner is attractive by hand-held scanner standards. If you want a HAM-capable colour scanner, there's nothing to touch this for the price.

POWER COLOUR HAND SCANNER is available from **Power Computing** on **0234 843388**
Price: £239

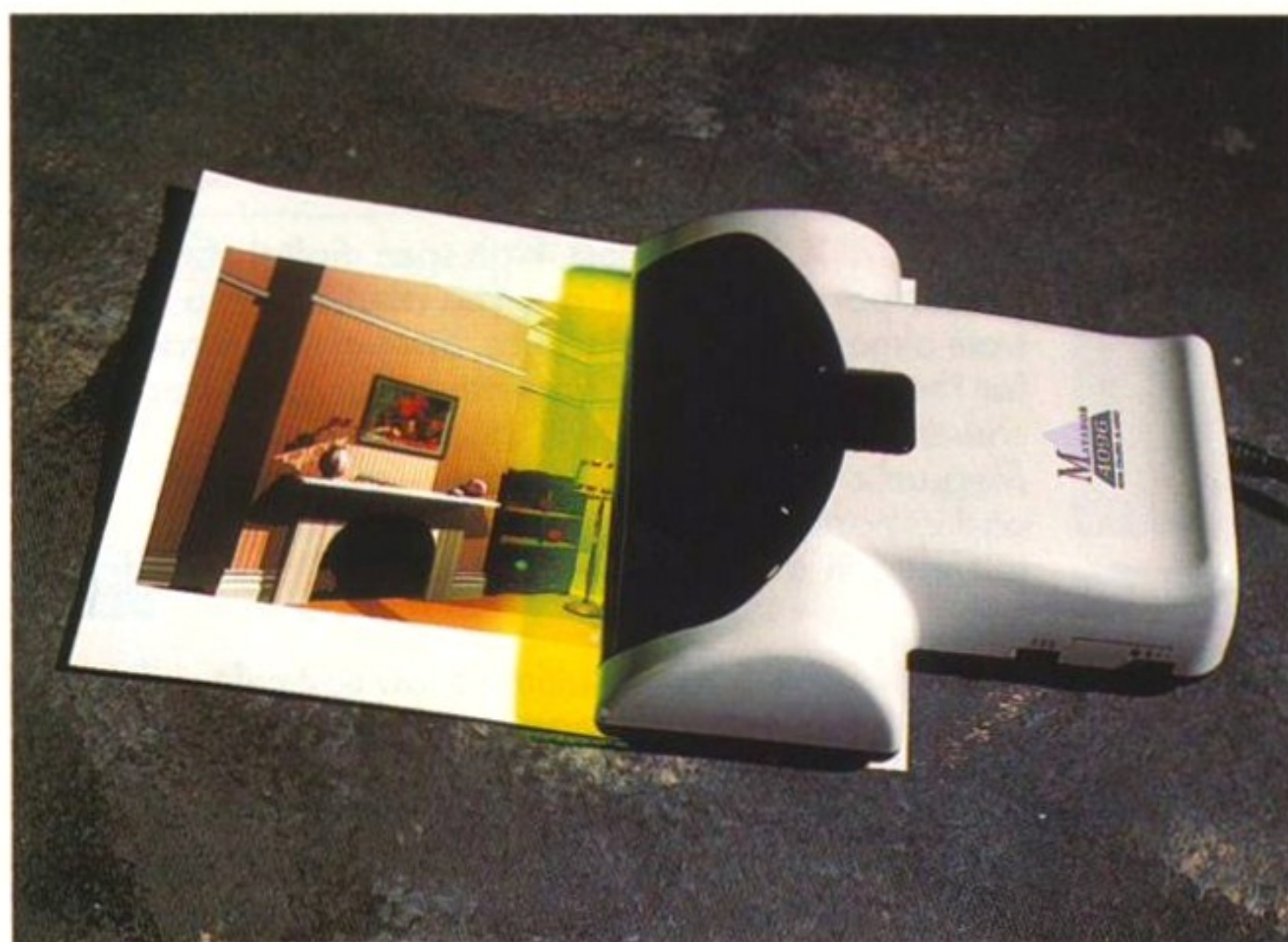

Power colour han



The Epson is powered by a professional-looking and easy-to-understand interface, courtesy of ASDG's Art Department.

The resulting scanned images exhibit good contrast range, saturated colours, deep blacks and pure whites. Perfect scans in fact.



scanner

scanner is able to handle such high resolutions that the transparency unit becomes a viable accessory. Imagine, if you will, the typical user for this piece of kit – the professional DTP'er. He will need to be outputting bitmap graphics at a resolution of at least 200dpi. A typical flatbed scanner can handle about 300 dpi, so if it were used to scan a 35mm tranny, the dimensions of which are about 1.5" by 1", the final image would be around 450 by 300 pixels. An image of this size can only be output at about 2.25" by 1.5" on the printed page. A scanner with a 1,200dpi resolution can scan a 35mm tranny so that the final image can be output at 9" by 6", which is obviously considerably more useful.

Operation of the scanner is simplicity itself. Firstly you run the scan-to-disk software, or choose Epson 300 SC from your *AdPro* loaders menu, and you are then presented with a preview scan screen. From here you can make a low-resolution scan of the whole scanner bed, and you are then presented with a mono thumbnail (small scale) of the image.

You can now choose the position and size of the actual scan, and choose the resolution that the 'fine' scan will have. The 'proof' scan screen gives a running indication of how much memory the final scan will require, and warns you if this exceeds the amount available. The 'preview' scan's brightness is adjustable, but this is purely to make it easier to view the preview and doesn't affect the fine scan.

Once you are happy with the preview scan

settings, pressing the accept button takes you to the fine-scan window. This is the business end of things, where you can control the quality of your final scanned image. Here is where decisions are made about bit depth, brightness, gamma and colour correction. Users who are scanning into *AdPro* will be able to further fine tune these factors by using the program's excellent image-processing facilities.

The GT-6500 is an extremely desirable piece of kit. If you need to scan transparencies for the Amiga there's nothing to touch it (or even come close to) for the price.

Epson GT-6500

- SPEED** ●●●●●
Possibly the fastest quality colour scanner *Amiga Format* have ever seen.
- DOCUMENTATION** ●●●●●
Epson's scanner documentation is very good, ASDG's software manual is every bit its match.
- ACCESSIBILITY** ●●●●●
No need to even look in the manuals, just do what the on-screen information suggests.
- FEATURES** ●●●●●
Full 24-bit colour scanning on the desktop for under £1,000. And a transparency option too.
- VALUE** ●●●●●
Outstanding value for money. This piece of kit sets whole new standards.



97%



The interface isn't attractive, but it is easy to use. The colour changes with the HAM base colours of your image.

A PowerScan3 scan. Blacks could be more solid, and colours more saturated, we tried hard, but couldn't improve on this.

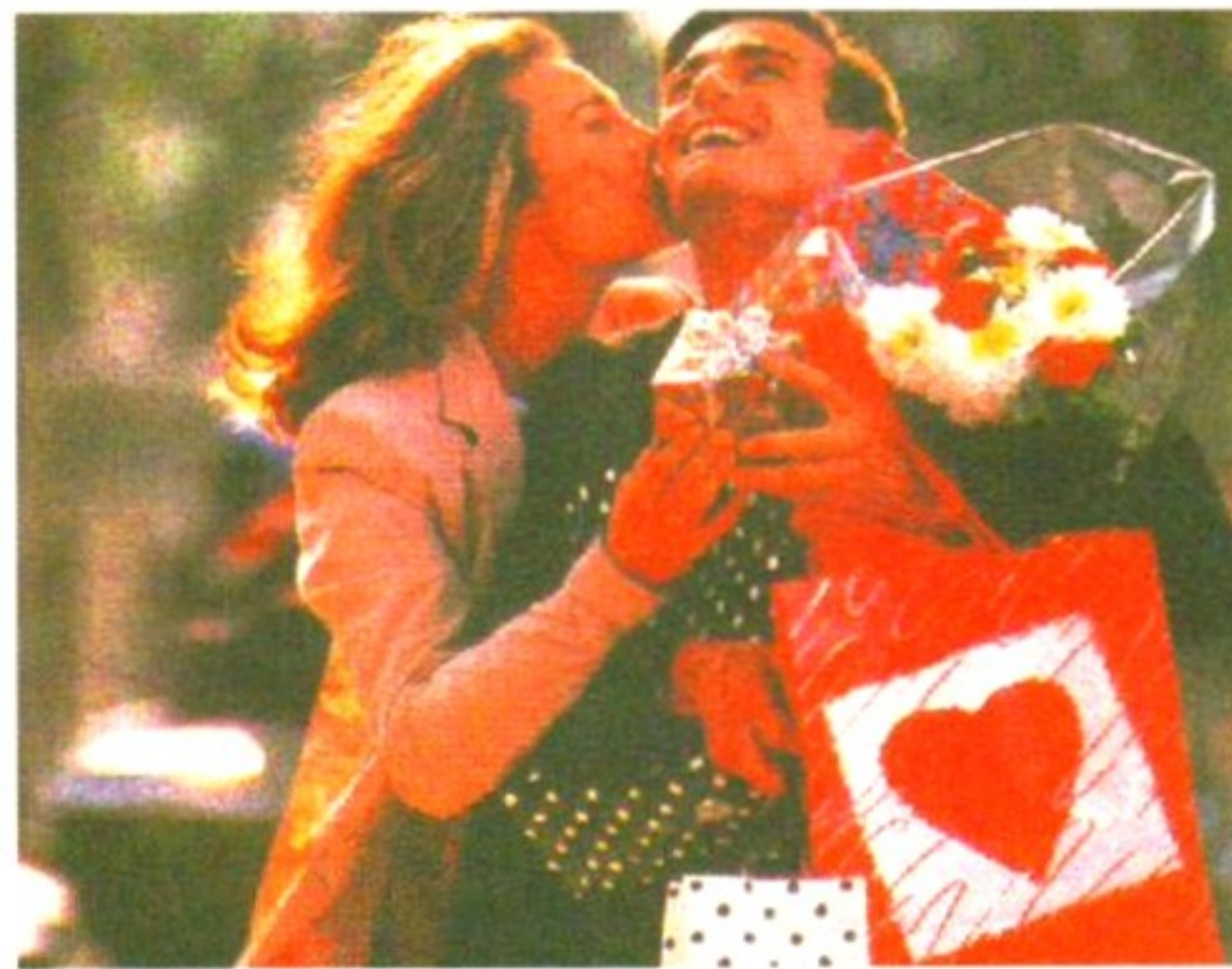

a Zorro slot, then place a flange with the scanner socket in the back of the machine. Simple!

The software is equally simple to install, but surprisingly powerful considering the budget nature of the package. The system works by a series of toolboxes, all of which are accessible from the main toolbox with the simple click of a mouse button. Pressing the scanner icon brings up the scan menu, which again is a toolbox that enables you to either scan an image to the screen or into the clipboard.

By selecting the scan icon, a requester then enables you to enter the width and height of the desired scan, and check the scanner for resolution settings. This hand-held is capable of scanning at up to 200dpi, and a switch on the scanning head enables you to select 1, 3/4, 1/2, and 1/4 settings, which equates to 200, 150, 100 and 50dpi respectively.

Scans wider than the 104mm width of the scanner's head can be made, but you have to scan the overlapping strip and piece it together with the rest of the scan. This is a hit-and-miss affair, but when you consider the software has automatic colour correction, the chance of getting a convincing colour match at the join is quite remote. Once you're happy with the settings click on 'Okay!' and the scan head will light up. It's then time to draw the scanner over the image. It takes a few minutes for the software to interpret the image data and then the picture appears on-screen as a super bitmap.

The scan we've made here shows little in the way of colour saturation and contrast, and

nothing we did with the scanning settings or the image-processing software could satisfactorily correct the matter. The PowerScan3 software can only perform simple image-processing tasks.

Improvements in future releases of the software may lead to better interpretation of the image data, but for the time being users will have to grin and bear it. Not that the image quality is bad, it's just not as good as one might have hoped. But that doesn't change the fact that this is the cheapest and easiest ways of getting colour images into the Amiga. As such, it is worth serious consideration.

PowerScan3

- SPEED** ●●
Colour scanning is never a fast operation, but PowerScan3 is slow by any standards.
- DOCUMENTATION** ●●●
The documentation is fair, but it would benefit from better illustration and an index.
- ACCESSIBILITY** ●●●●●
After a quick referral to the manual, getting started with PowerScan is quick and painless.
- FEATURES** ●●●●●
A number of image-processing features make the software unexpectedly good.
- VALUE** ●●●●●
This is the cheapest way to scan images into the Amiga, and for the money it's very tasty.



79%

d scanner

NOW A4000 & A1200 / AGA CHIP SET COMPATIBLE FOR 256 COLOURS ON SCREEN!

LIMITED TIME OFFER
£99.99*

4.0 PROFESSIONAL PAGE®

THE BEST PROFESSIONAL PUBLISHING SYSTEM FOR THE AMIGA, EVEN FOR THOSE WHO DON'T WANT TO MAKE A CAREER OF IT

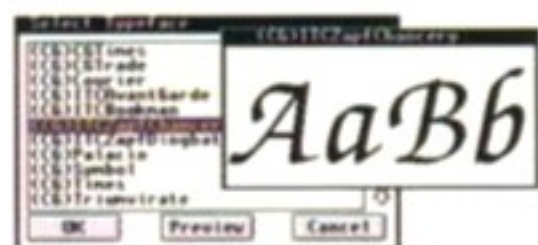

The new Font Preview saves you time by letting you see your fonts before you apply them!



The unique Page Sorter lets you easily arrange your pages using just your mouse!

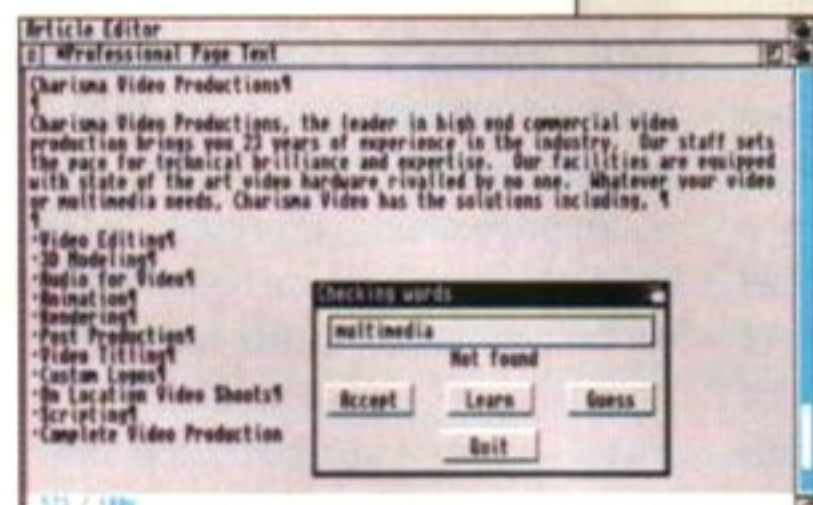

Free Word Processor

- Mouse click brings your text here for super fast editing and changes!
- Full high speed word processor!
- 90,000 word spell checker!
- Powerful search & replace and more!

Non-printing stick on style notes make it easy to leave reminders for yourself or others.

User-definable Zoom means you'll get the view you want, from 10% to 400% for greater precision!

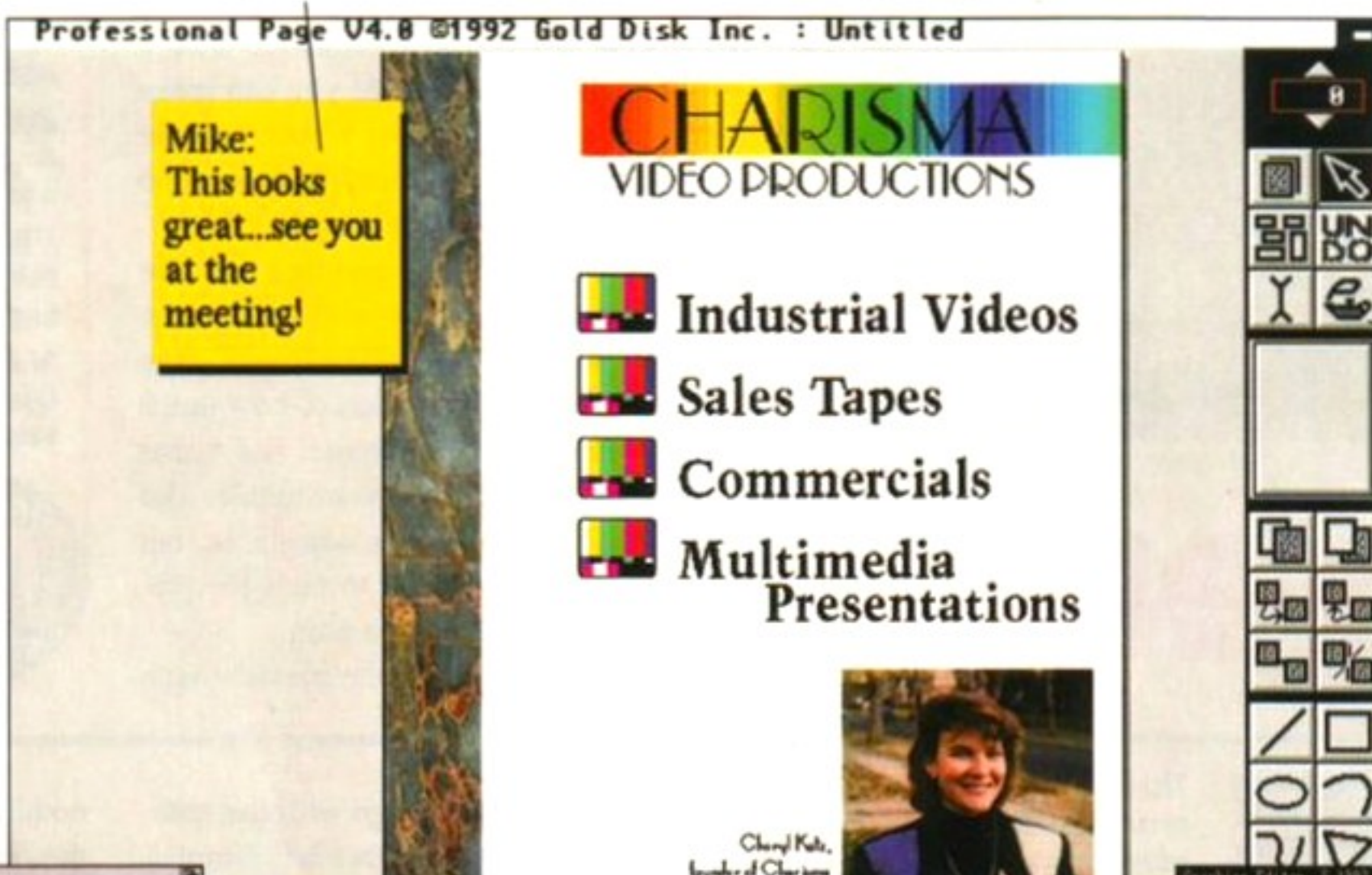

Mike:
This looks great...see you at the meeting!

- Industrial Videos
- Sales Tapes
- Commercials
- Multimedia Presentations

Cheryl Kite,
founder of Charisma

A4000 / AGA chip set support lets you see up to 256 colours on screen at once for a photo-realistic view of your work.

Import graphics from a wide range of formats and platforms, including: IFF, GIF, TIF, PCX, BMP, Pro Draw, EPS with TIF preview header, PLUS Adobe Illustrator and Aldus Freehand files can be imported and even hot-linked to Professional Draw for editing!

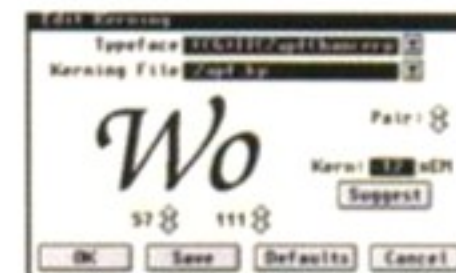

The built-in Pair Kerning lets you visually adjust letter pairs for automatic kerning!

Page and Function Genies actually layout your pages for you and perform all kinds of tasks like table creation, drop caps and more. 4.0 has even more time saving Genies. And you get a special Genie Editor that makes it easy to write your own.

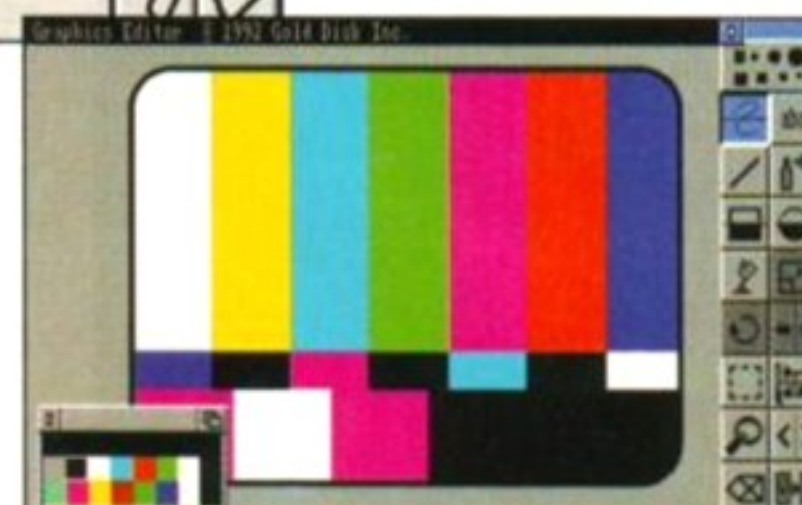

Free Paint Program

- Mouse click brings your graphic here for super fast editing and changes!
- Full paint program lets you create or edit graphics quickly and easily!
- Powerful paint tools!

THE BEST PROGRAM

The new Professional Page 4.0 makes it easier than ever to produce professional documents that enhance your image and improve your business. A host of new graphic and text import filters give you greater connectivity to other programs and platforms. Plus with our free hot-linked word processor and paint program, any design changes are fast and easy.

In fact, from the new font preview to the variable zoom to the advanced visual page sorter, Professional Page 4.0 makes professional layout a snap. You can even see and edit two pages at once. Or visually change the kerning of your fonts. And don't forget the Genies that will layout your pages for you and even perform mail merge and other time savers.

THE BEST VALUE!

No matter what your business is, from Desktop Publishing to Video Production, Professional Page is the answer to quickly creating great looking documents that make you money.

And speaking of money, all this extra value still sells for the same low price of £199.95. And for a limited time you can take advantage of our special introductory price of just £99.99*, a real bargain! If you already own Professional Page, call right away for your special upgrade price.

Professional Page 4.0, the power, the reputation, the consistent leader in Amiga publishing. Period.

Call 081 309 1111 or see your dealer today!

SILICA SYSTEMS

081 309 1111

HOTLINE



GOLD DISK

P.O. Box 789 Streetsville
Mississauga, Ontario L5M 2C2 Canada

FREE! ZOOL



SOFTWARE PACK
WHEN YOU BUY AN AMIGA
FROM SILICA

PLUS!



GFA BASIC +
PHOTON PAINT 2

TOTAL VALUE OVER **£265**

Silica are pleased to offer THE Software Pack of the Year FREE with every Amiga purchased at normal Silica prices. It includes the sensational new title ZOOL which has received rave reviews as the most original game ever seen on the Amiga.
ZOOL - "Knocks the socks off Sonic." - 97% - Amiga Computing - Nov '92
STRIKER - "Footballer of the Year - and no mistake..." - 94% - CU Amiga - June '92
PINBALL DREAMS - "It's quite simply superb" - 94% - AUI - Sept '92
TRANWRITE - Premier word processor (UK version) with a 90K spell checker.
Plus, with every Amiga from Silica, we will give you Photon Paint 2 paint package and GFA Basic programming language. A total of over £265 worth of free gifts.

ZOOL PACK:
ZOOL - platform title of the year... £25.99
STRIKER - soccer simulation... £25.99
PINBALL DREAMS - pinball simulation... £25.99
TRANWRITE - word processor... £49.95
PLUS!
GFA BASIC v3.5 - programming language £50.00
PHOTON PAINT 2 - paint package... £99.95
£267.87

NEW! AMIGA 1200



- Motorola 68020EC Processor
- 14.19MHz Clock Speed
- 32-bit Architecture
- 2Mb Chip RAM Standard
- Amiga DOS v3.0
- AA Chip Set for Enhanced Graphics
- 16 Million Colour palette
- 2-256 Colours on Screen
- 1 x 32-Bit CPU/RAM Expansion Slot
- PCMCIA Smart Card Slot takes 512K - 4Mb PC Cards
- Built-in TV Modulator
- 96 Key keyboard with Numeric Keypad
- 2 1/2" Internal Hard Drive Optional Extra
- 1 Year On-site Maintenance

£399
INC VAT - Ref: AMC 1200

INCLUDES BUILT-IN 18-KEY NUMERIC KEYPAD

AMIGA 600 SALE OFFERS!

WILD, WEIRD & WICKED EPIC 'HARD DRIVE' PACK



The Wild, The Weird and The Wicked (WWW) is the Amiga 600 games pack. It comes complete with Amiga 600 computer and mouse, plus a range of high quality entertainment software.
NORMAL RRP: **£349**
£319
SILICA OFFER: INC VAT Ref: AMC 0649

The Epic Language Pack is based around the A600HD, the A600 with 20Mb hard drive. It includes challenging adventure games and software for the linguistically minded!
SILICA OFFER:
NORMAL RRP: **£499**
£399
40Mb Hard Disk Version: £449 INC VAT - Ref: AMC 0899

AMIGA COMPUTERS

£100 OFF AMIGA 600HD SILICA SALE - £399 SEE BOTTOM LEFT

RETURN THE COUPON FOR A FREE COPY OF SILICA'S NEW 64 PAGE COLOUR CATALOGUE

AMIGA 600
with FREE! **LEMMINGS** AND **DELUXE PAINT III**

PLUS! FREE! ZOOL PACK + MORE! - SEE LEFT

2Mb RAM OPTION SEE BELOW

FREE! 1 YEAR AT HOME WARRANTY

The new Amiga 600 features a 3 1/2" floppy drive, mouse, TV modulator and smart card slot all as standard. The very latest Kickstart/Workbench v2.05 is used in the Amiga 600 along with an enhanced chip set. See below for pack options and free gifts from Silica.

A600 + LEMMINGS + DPAINT III
£299
INC VAT - Ref: AMC 0666

AMIGA 600 HOLDALL

A high quality holdall for storage and transportation of your Amiga 600.



- 1 Webbed handles with padded grip
- 2 Wrap around dual zipper
- 3 Real leather badge
- 4 Outer pocket with velcro and stud fasteners. Folds flat when not in use.
- 5 Zip fastened pouch inside
- 6 Removable, adjustable shoulder strap with padding
- 7 Non-slip, solid rubber feet
- 8 Large inner pocket
- 9 3 smaller pockets for disks



Available with choice of badges: Console Carrier NBA 3000, ComputaGrip NBA 3500, COMPUGRIP
SILICA PRICE ONLY
£14.95
Ref: NBA 3000 or NBA 3500

AMIGA 600/1200 HARD DRIVE

Silica are pleased to introduce GVP's first A600/A1200 upgrade, a high speed 85Mb internal hard drive. The hard drive is based on a new Maxtor mechanism offering ultra fast data transfer and access times with the reliability and quality that you would expect in a GVP product. The compact unit comes with GVP's market leading hard drive formatting software (FaaastPrep) and a full two year warranty for your peace of mind. Also included is a manual giving full instructions.

- FEATURES:**
- Ultra fast Maxtor hard drive.
 - 85Mb Capacity.
 - Compact 2.5" mechanism.
 - Low cost IDE technology.
 - Internal fitting conserves desk space.
 - GVP's FaaastPrep software + Manual.
 - Complete fitting kit included.
 - Fitting service available.
 - Two year hard drive warranty.

FITTING SERVICE
Because fitting ANY internal hard drive yourself will invalidate your Amiga's warranty, Silica offer a fitting service. Silica's trained engineers will professionally install the hard drive in your Amiga, keeping your Amiga warranty intact and then return the Amiga to you by free courier delivery.

MAXTOR 85Mb HARD DRIVE Inc GVP FITTING KIT
£299
INC VAT Ref: HAR 0785
Fitting £135 - £25 VAT - £29.38

AMIGA 600 OPTIONS	NO HARD DRIVE		20Mb HARD DRIVE
	LEMMINGS	WWW PACK	EPIC PACK
1Mb A600 + Mouse, 3 1/2" Drive, TV Mod, Smart Card Slot	£299.99	£299.99	£299.99
20Mb HARD DISK - Storage for programs and data	-	-	£299.00
DELUXE PAINT III - Graphics and animation	£79.99	£79.99	-
LEMMINGS - Save the Lemmings	£25.99	-	-
MICROPROSE GRAND PRIX - Racing Sim	-	£34.99	-
SILLY PUTTY - The pliable arcade game	-	£25.99	-
PUSH OVER - A game of puzzles	-	£25.99	-
EPIC - A Sci-fi adventure	-	-	£29.99
ROME - Role playing adventure	-	-	£25.99
MYTH - Stop the spread of evil	-	-	£19.99
TRIVIAL PURSUIT (in 3 languages)	-	-	£29.99
WORD PROCESSOR + DICTIONARY (5 languages)	-	-	-
1 YEAR ON-SITE WARRANTY	-	-	-
PLUS! - FREE FROM SILICA			
ZOOL PACK - see panel above	£127.92	£127.92	£127.92
PHOTON PAINT v2.0 - Art package	£89.95	£89.95	£89.95
GFA BASIC INTERPRETER v3.5 - Prog language	£50.00	£50.00	£50.00
TOTAL PACK VALUE:	£673.84	£734.82	£972.82
LESS PACK SAVING:	£374.84	£355.82	£573.82
SILICA PRICE:	£299	£319	£399
2Mb RAM	+£45	+£45	+£45
PRICE OF UPGRADE INC BATTERY BACKED CLOCK			

ALL PRICES INCLUDE VAT - DELIVERY IS FREE OF CHARGE IN THE UK MAINLAND

080193-0630

SILICA SYSTEMS OFFER YOU

- **FREE OVERNIGHT DELIVERY:** On all hardware orders shipped in the UK mainland.
- **TECHNICAL SUPPORT HELPLINE:** Team of technical experts at your service.
- **PRICE MATCH:** We normally match competitors on a "Same product - Same price" basis.
- **ESTABLISHED 14 YEARS:** Proven track record in professional computer sales.
- **£12 MILLION TURNOVER (with 60 staff):** Solid, reliable and profitable.
- **BUSINESS + EDUCATION + GOVERNMENT:** Volume discounts available 081-308 0888.
- **SHOWROOMS:** Demonstration and training facilities at our London & Sidcup branches.
- **THE FULL STOCK RANGE:** All of your requirements from one supplier.
- **FREE CATALOGUES:** Will be mailed to you with offers + software and peripheral details.
- **PAYMENT:** Major credit cards, cash, cheque or monthly terms.

Before you decide when to buy your new Amiga computer, we suggest you think very carefully about WHERE you buy it. Consider what it will be like a few months after buying your Amiga, when you may require additional peripherals or software, or help and advice with your new purchase. And, will the company you buy from contact you with details of new products? At Silica Systems, we ensure that you will have nothing to worry about. We have been established for almost 14 years and, with our unrivalled experience and expertise, we can now claim to meet our customers' requirements with an understanding which is second to none. But don't just take our word for it. Complete and return the coupon now for our latest FREE literature and begin to experience the "Silica Systems Service".

MAIL ORDER HOTLINE
081-309 1111

SILICA SYSTEMS

MAIL ORDER: 1-4 The Mews, Hatherley Rd, Sidcup, Kent, DA14 4DX Tel: 081-309 1111
Order Lines Open: Mon-Sat 9.00am-6.00pm No Late Night Opening Fax No: 081-308 0608

LONDON SHOP: 52 Tottenham Court Road, London, W1P 0BA Tel: 071-580 4000
Opening Hours: Mon-Sat 9.30am-6.00pm No Late Night Opening Fax No: 071-323 4737

LONDON SHOP: Selfridges (1st Floor), Oxford Street, London, W1A 1AB Tel: 071-629 1234
Opening Hours: Mon-Fri 9.30am-7.00pm (Sat close 6.30pm) Late Night: Thursday - 8pm Extension: 3914

SIDCUP SHOP: 1-4 The Mews, Hatherley Rd, Sidcup, Kent, DA14 4DX Tel: 081-302 8811
Opening Hours: Mon-Sat 9.00am-5.30pm Late Night: Friday - 7pm Fax No: 081-309 0917

ESSEX SHOP: Keddies (2nd Floor), High Street, Southend-on-Sea, Essex, SS1 1LA Tel: 0702 468039
Opening Hours: Mon-Fri 9.30am-5.30pm (Sat 9.00am-6.00pm) No Late Night Opening Fax No: 0702 462363

To: Silica Systems, AMFOR-0393-80, 1-4 The Mews, Hatherley Rd, Sidcup, Kent, DA14 4DX

PLEASE SEND A 64 PAGE AMIGA COLOUR CATALOGUE

Mr/Mrs/Miss/Ms: Initials: Surname:

Company Name (if applicable):

Address:

Postcode:

Tel (Home): Tel (Work):

Which computer(s), if any, do you own?..... 80K

Word publishers are a popular alternative to DTP programs. **Phil South** finds out if Excellence – an update of Scribble! – can face up to the competition ...

Excellence!

Word publisher ■ £79.95 ■ MSS

WAY BACK IN the Amiga's short, but ground-breaking history there was a word processor called *Scribble!* (it was also given away on the *AF 41 Collection Coverdisk*). At the time of its release, this was the premier word processor on the Amiga. What was so good about it was that you could type in a lot of words, spell check them, print them out, and do the whole job simply and quickly, without any fuss.

Then MSS 'improved' the design by adding graphics, a thesaurus, a grammar checker, and the whole thing slowed down so much it was impossible to use on anything but an accelerated machine. And the output was rubbish, unless you used NLQ (Near Letter Quality) mode. This was fairly typical, how do software houses do it? They improve something, and it's worse than it was before.

The second revision of the program wasn't much better, although to be fair there were fewer bugs. But due to the huge screen resolutions required, and the amount of graphics crunching needed to add graphics to your programs, it was slow and the output was questionable unless you had an expensive printer – it wasn't even very bright on a colour dot matrix, the very kind of printer the program was written to drive.

Now we have revision 3 in the form of *Excellence!*, which although is cosmetically different with a few extra features, it still suffers from many of the pitfalls of the original revision. Fonts loaded into the program look stretched vertically, unless you use flicker mode (OK for flicker fixer or A3000 users) or use specially created fonts, or fonts which look all right in hi-res mode. Output is possible in NLQ mode, which makes use of any fonts your printer has: PostScript mode, which drives a PS printer with special printer fonts; and Graphic mode, which enables you to use colour graphics and fonts with your printer.

The Graphics mode relies upon the awful smoothing that Amiga prefs printer drivers apply to graphics and bitmapped text to improve the low quality. This is nowhere near the quality that you could expect from a word processor which produces outline fonts.

There is a utility to convert metric files from CG fonts into meaningful fonts for *Excellence!*, but once again this merely involves turning basically OK fonts into jaggy ones, which seems pointless in the extreme.

The manual is a nice thick book, but not completely accurate. On several occasions I

The first version of *Excellence!* was in fact the excellent *Scribble!*, though this was just a standard word processor, and it couldn't import graphics, like this nice picture of Arnie.

EXCELLENCE! is available from HB Marketing on 0753 686000

One good thing about the overhaul of the program is that it does have the look and feel of Workbench 2.

Although it has 'What You See Is What You Get', the print quality will probably mean that you don't.

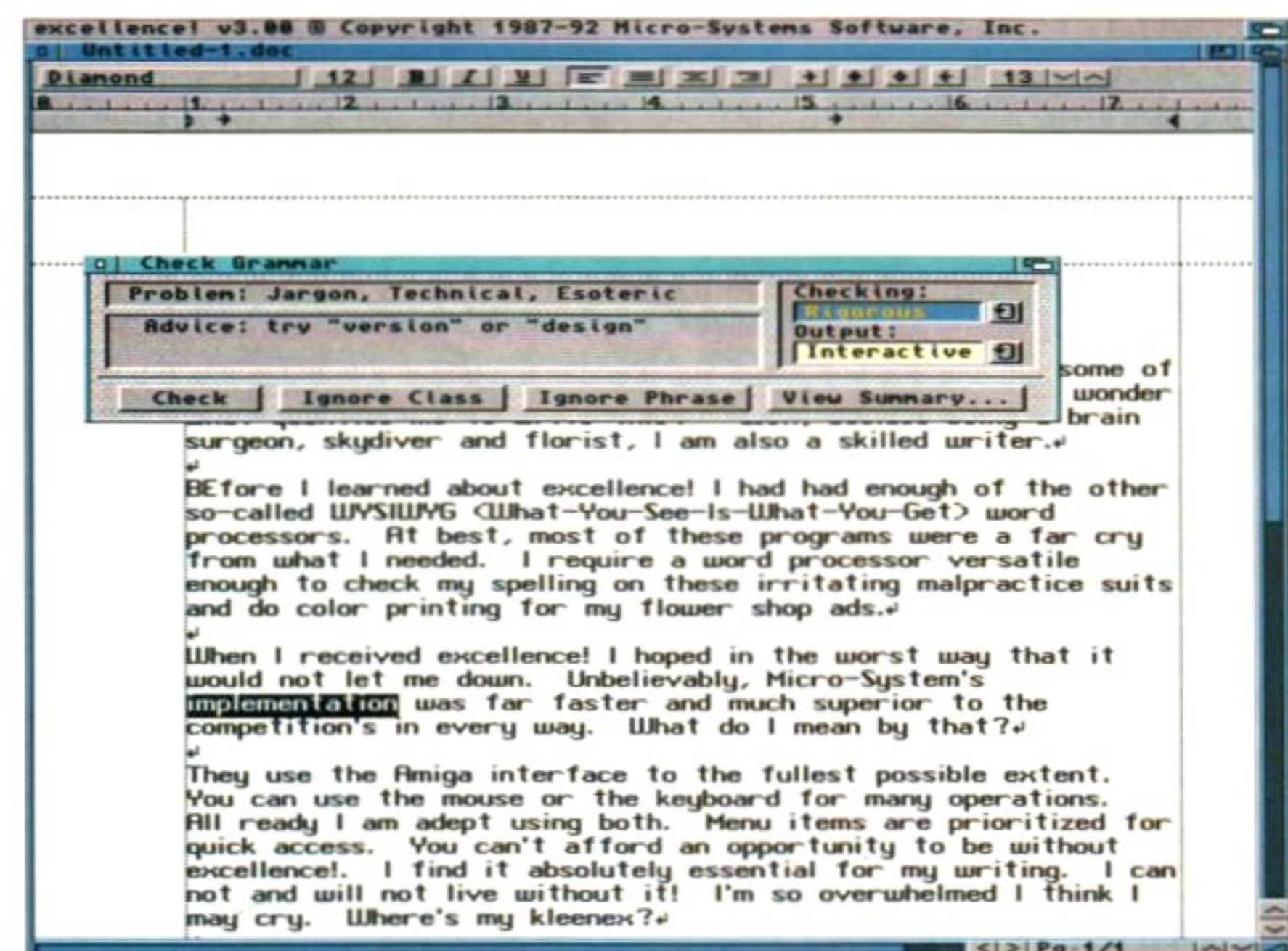
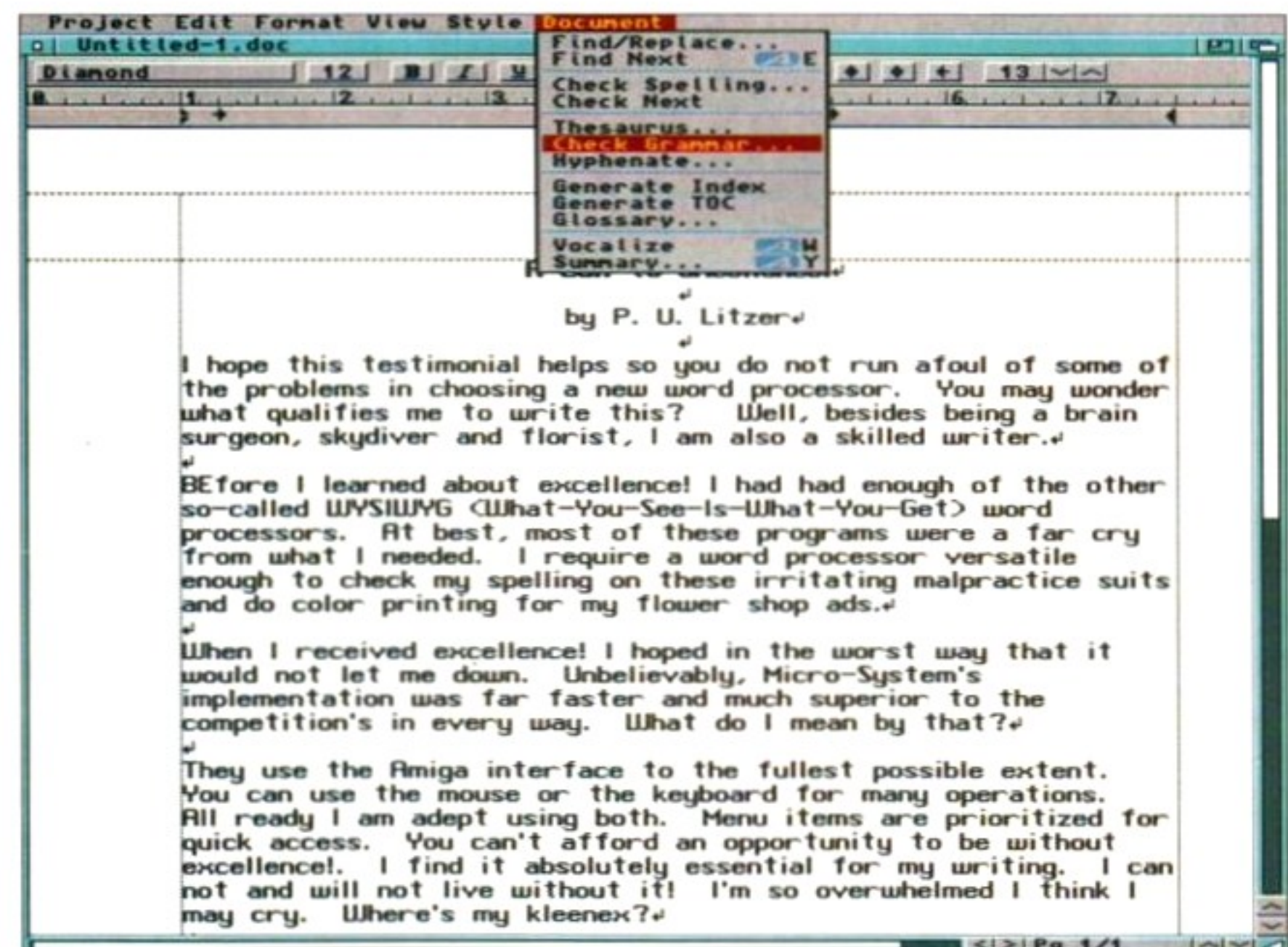
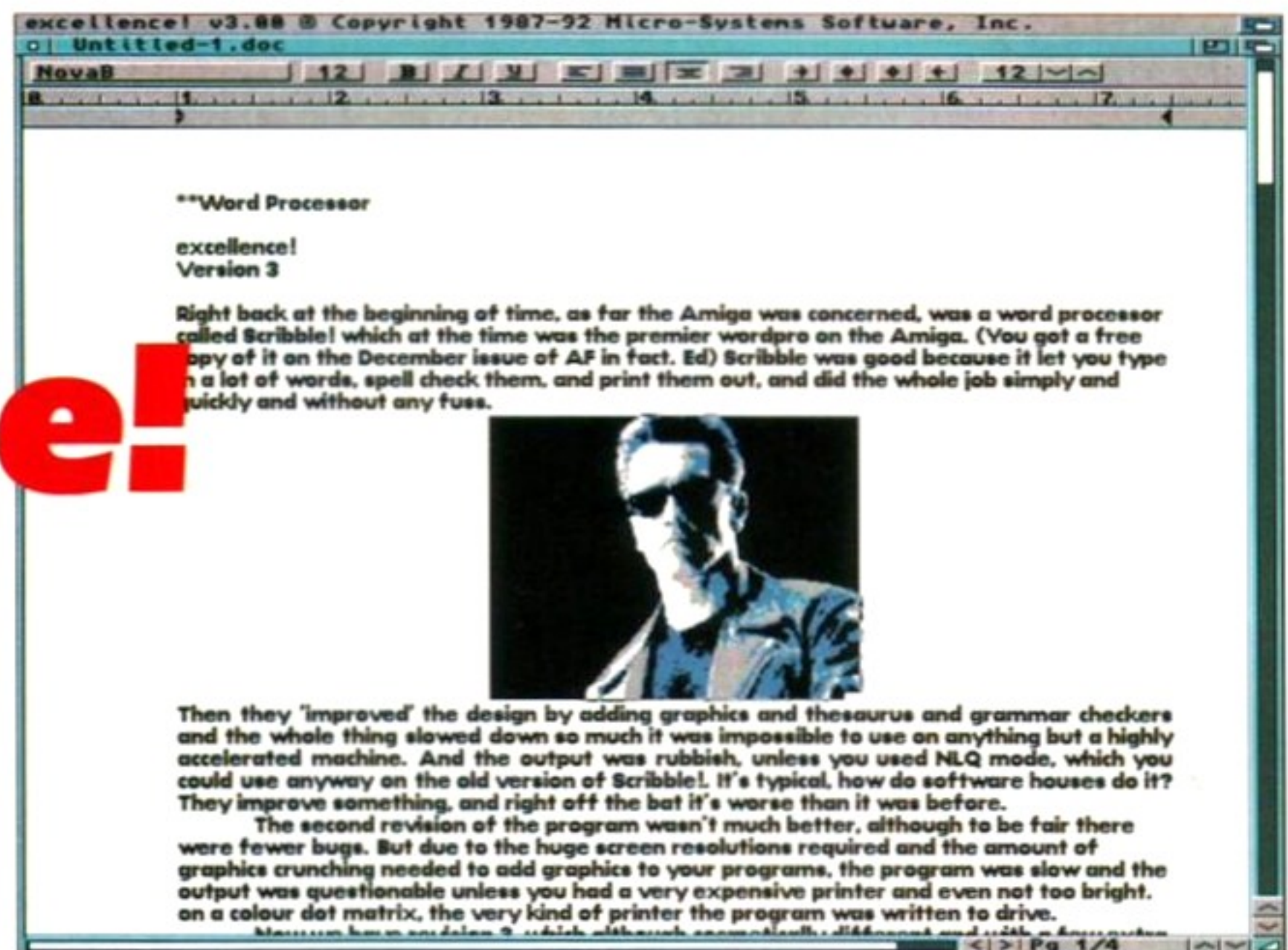

EXCELLENCE! VERSUS WORDWORTH 2 AND FINAL COPY II



How does *Excellence!* compare to its peers? Well just take a look at the bottom line...

Excellence! is pitching itself against two other word publishers here in the UK: *Final Copy 2* by Softwood in the US (although it's supported in the UK by Gordon Harwood Computers) and the *Wordworth 2* program from Digita, an English company. But its two rivals are better thought out and feature PostScript output and UK English dictionaries. The main problem with *Excellence!* is that it is

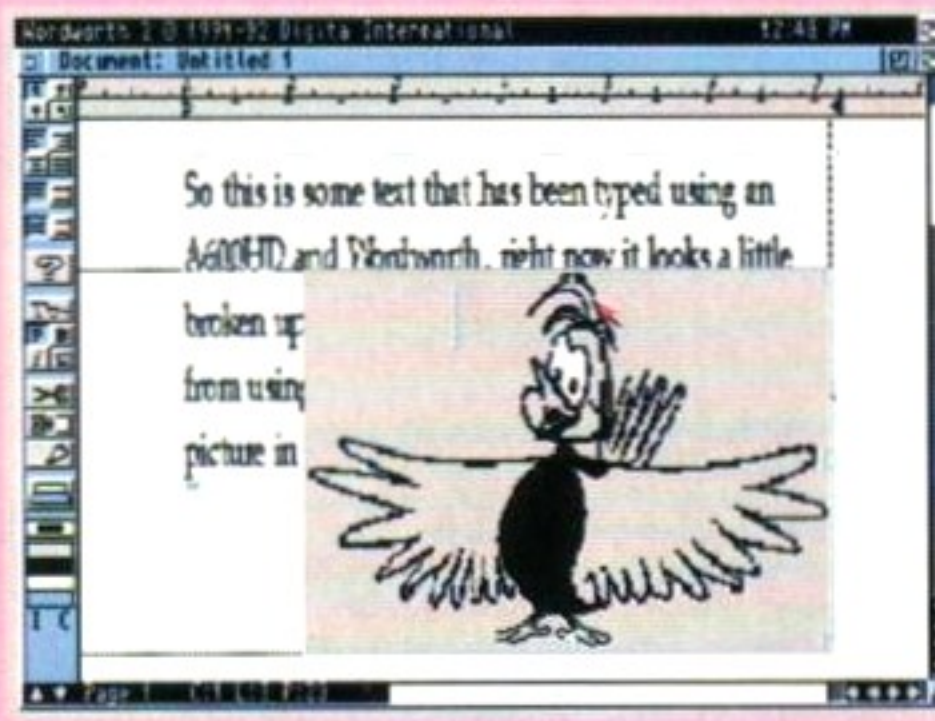

We reviewed *Wordworth 2* in *Amiga Format* 41 and we gave it a *Format-Gold* winning 91 per cent.

an old product which still has problems adapting to life in the nineties. Its updates simply don't bring it into line with the other two programs.

If I pressed to buy any of these products, *Wordworth 2* would be my first choice. Digita have improved its word-processing utilities, and the on-screen fonts by using the Agfa Intellifont system, plus the print quality is superior to *Excellence!*'s.



Final Copy II was reviewed in *Amiga Format* 42 and was awarded 84 per cent.

Next I'd go for *Final Copy 2* and a copy of Softwood's grammar checker. *Final Copy* has some nice outline fonts which look good on any printer, and it performs just as well on PostScript or inkjet-type printers.

Third – and last – would be *Excellence!*, but the print quality would be rather poor in comparison, especially on a dot matrix.

was directed to turn to page 45, but what I was looking for was 10 pages further on. This is foolish. Don't they check stuff like this?

On a more positive note, the program has the facility to index and create glossaries, so your documents can look like proper technical documents, with footnotes too. And timed saves which back up your documents after a specified time period are useful. There's also support for the new Amiga resolution modes like Super Hi-res, plus support for the NEC 4FG monitor (reviewed *AF* 38 – 93 per cent).

There's now a speech mode so your Amiga can read your documents back to you (useful for partially sighted or blind people). The font menu has been replaced by a requester, so the program can access any fonts on your system (welcome to the nineties). ARexx support is available, plus the facility to use foreign-language dictionaries, Appcon and AppMenu support on Workbench 2 machines and all manner of cosmetic updates.

However, even with all these new features, the program is still limited and the major flaws have not been addressed. What is needed is a complete rewrite, not just an update.

The main problem is that in order to get good-quality output you have to either know a lot about the way the Amiga works, or have a lot of ancillary gear like PostScript printers

and an accelerator to make the program work properly. Although the same could be said of many top-end software these days, a word publisher is fairly mid-range and so should be easy to use, while still deliver quality results. Sadly *Excellence!* does neither.

If you're going to ruin the basic function of a word processor by adding graphics support and fonts, then the graphics and font handling had better be damn good. The problem with *Excellence!* is that they're not. Printing bitmap fonts on the Amiga has never been a really viable option because the fonts are low resolution (at least as far as a printer is concerned) and so they can't really produce top-quality output.

“If you're going to ruin the basic function of a word processor by adding graphics support and extra fonts, then these had better be damn good.”

Excellence! is a good idea which fails to deliver because MSS have not thought it through. Sure, if you've got a PostScript printer then you're laughing, everything will look great. But what if you've got a dot-matrix printer? The poor print quality would not make anyone happy. The only really safe way of using bitmaps is to use fonts twice the size you

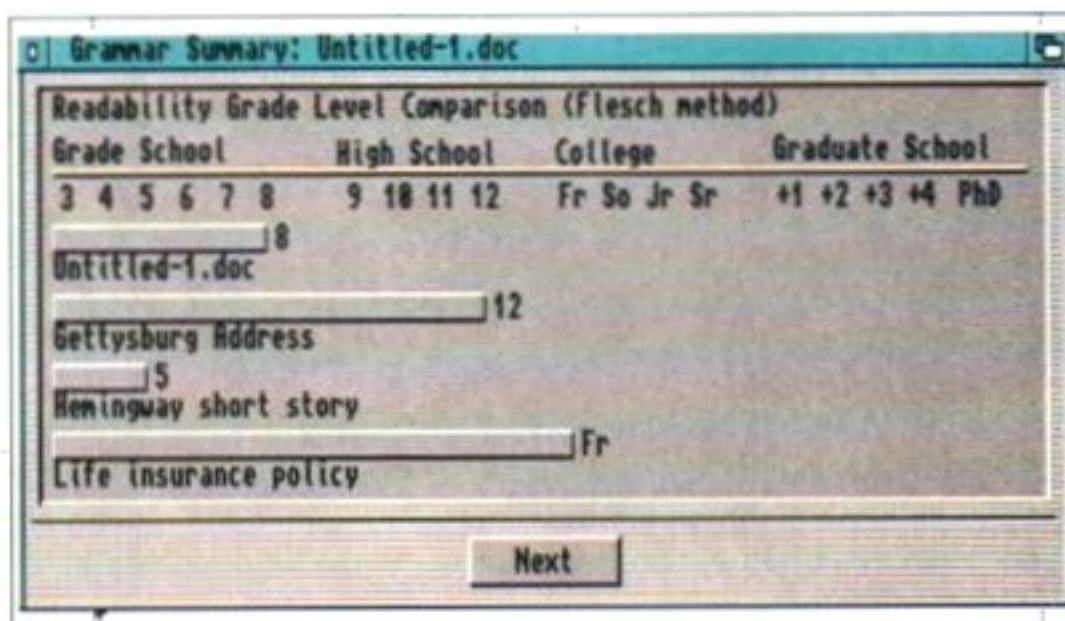

The grammar checker checks the readability of your text and grades it according to the Flesch method – whatever that is.

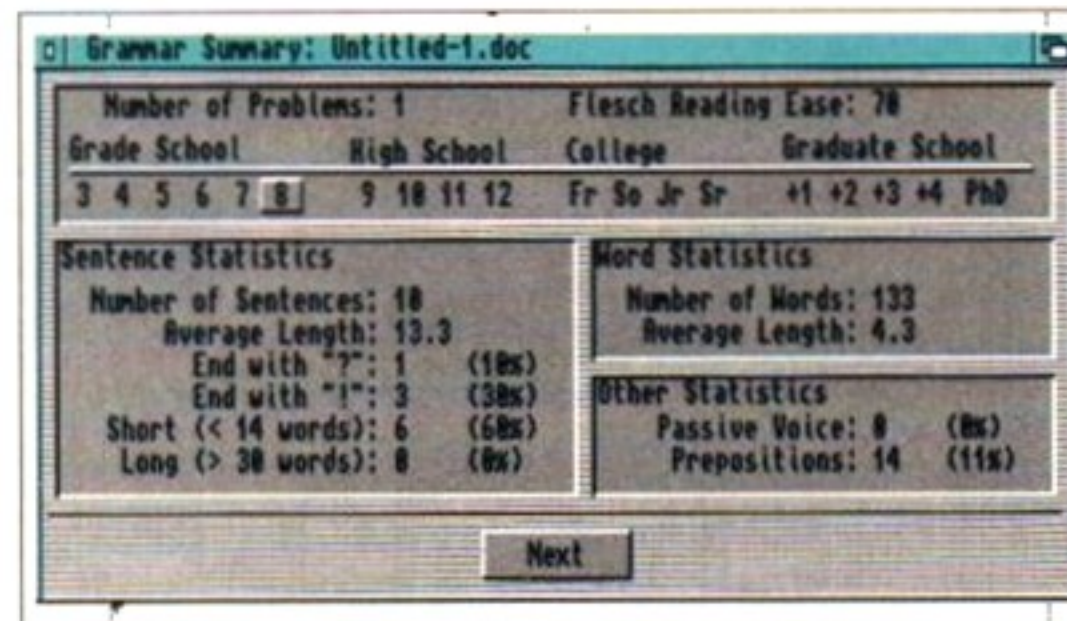

By checking your grammar! and punctuation!!, you can check if you have been too liberal with your exclamation marks!!!

Excellence!

SPEED	● ● ●
Not fast at all really, although it is an improvement on previous revisions.	
DOCUMENTATION	● ● ● ●
Nice fat book, with a supplement for the new version tacked in the front.	
ACCESSIBILITY	● ● ●
Easy to start using, but a lot of faffing is required to get the best out of it.	
FEATURES	● ● ● ●
Top marks for the spelling/thesaurus/grammar checking, but it falls down on output.	
VALUE	● ● ●
A lot of features, but it's let down by poor output on anything but PostScript printers.	



64%

Evesham Micros • CALL US NOW ON (0386) 765500 • Evesham Micros • CALL US NOW ON (0386) 765500 • Evesham Micros • CALL US NOW ON (0386) 765500 • Evesham Micros

PRINTERS

Prices Include VAT, Delivery and Connection Cable

ALL EVESHAM MICROS STAR PRINTERS INCLUDE 12 MONTHS ON-SITE WARRANTY

Star LC 20 Successor to LC 10, 4 fonts, 180/44cps	£ 129.99
NEW! Star LC 100 Entry level 9-Pin Colour, 4 fonts	£ 168.03
Star LC 200 9-Pin Colour, 4 fonts, 180/45cps	£ 198.58
NEW! Star LC 24-100 24-Pin, 5 fonts, 192/64cps	£ 196.23
Star LC 24-200C Superb 24-Pin Colour, 5 fonts, 200/67cps	£ 276.13
Automatic Sheet Feeder for 10" LC printers (pls.state model)	£ 64.95
Star XB24-200 COLOUR 24-pin, 80 col. power printer	£ 405.38
Star XB24-250 132 column version of XB24-200	£ 492.33

Citizen 240 COLOUR printer	£ 299.99
Hewlett-Packard Deskjet 500	£ 351.33
Hewlett-Packard Deskjet 500C (Colour)	£ 445.33
NEW! Hewlett-Packard Deskjet 550 Colour	£ 562.83
Canon BJ-10EX Inkjet Printer	£ 222.08
NEW! Canon BJ-200 Inkjet Printer 360dpi, upto 240cps, 8 fonts, 80-sheet feeder, IBM and Epson emulation	£ 351.33
Epson LX400 budget 10" carriage 9-pin 180/25cps	£ 139.00
Epson LQ100 24-pin 180/60cps, 8k buffer	£ 205.00
Panasonic KXP1124I updated 24-pin model 300/100cps	£ 279.00
Panasonic KXP2123 good value 24-pin colour model	£ 269.08

TOP VALUE 400dpi HANDY SCANNER

QUALITY SCANNING - AT THE RIGHT PRICE!

At a genuine 400dpi scanning resolution, this scanner produces truly superb quality scans. Has a full 105mm scanning width, variable brightness control and 100 / 200 / 300 / 400dpi resolution. Daatscan Professional Version 3-scanning and editing software allows real-time scanning in either line art or in up to 64 simulated grey scales. Provides powerful editing features and excellent compatibility with most DTP and Paint Packages, eg. Deluxe Paint 4, Touch-Up. Also supplied is The Publisher DeskTop Publishing package, ideal for incorporating your scanned images into flyers and newsletters.



STILL ONLY £99.99

TRUEMOUSE



WE GUARANTEE that this is the smoothest, most responsive and accurate replacement mouse you can buy for the Amiga. Excellent performance, now with a 300dpi resolution. Amazing new price!

£14.99 SATISFACTION GUARANTEED

GOLDEN IMAGE OPTICAL MOUSE Amiga/ST compatible - excellent travel+accuracy assured. NEW LOW PRICE!... £ 29.00

TRACKBALL



High performance trackball, directly compatible to any Amiga or Atari ST. Plugs into mouse or joystick port. Super-smooth and accurate - you probably won't want to use a mouse again after using this Trackball! Full one-handed control. Top quality opto-mechanical design, giving high speed and accuracy every time. No driver software needed!

ONLY £29.95

NEW! A500 ROM SWITCHER

SWITCHING BETWEEN VERSIONS OF KICKSTART ON YOUR A500 IS EASY WITH OUR NEW ROM SWITCHER!

You can improve software compatibility on your A500 Plus! By fitting our ROM switcher, you can alternate between the Kickstart 2 already resident and another version of Kickstart ROM chip, giving you the freedom of choice. Fitting is very simple indeed, and requires no soldering or special technical knowledge. Fitting allows two methods of switching: either by keyboard reset, or by an external toggle switch. N.B. Kickstart ROM not supplied. A500 Revision 5A boards will require circuit modification.

ONLY £24.95

Kickstart 1.3 ROM supplied separately	only £29.95
Kickstart 2.0 ROM supplied separately	only £39.95
A500 Revision 5A PCB Circuit Modification Service	£29.95

ZY-FI Amplified Stereo Speakers

REALISE THE TRUE SOUND POTENTIAL OF YOUR AMIGA WITH THIS PAIR OF FULL RANGE SPEAKERS!



Your Amiga produces fine quality hi-fi stereo sound. Enjoy quality stereo sound reproduction to the full with this new design twin speaker system! Incorporates a built-in amplifier with separate adjustable volume controls for each speaker unit. Runs from PSU (supplied) or from batteries (not included).

ONLY £39.95

Speaker Dimensions 160x95x105mm (HxWxD)

AMIGA 600

EXCITING NEW PACKS

STANDARD PACK

With 12 months on-site maintenance

ONLY £279.99

2MB RAM/CLOCK VERSION £314.99



WILD WEIRD WICKED PACK

Features: Push-over • Grand Prix • Putty • Delux Paint III • 12 months on-site maintenance

ONLY £324.99

2MB RAM/CLOCK VERSION £359.99

EPIC PACK

Commodore's 20Mb Hard Disk version

ONLY £449.99

2MB RAM/CLOCK VERSION £484.99

4MB RAM CARD

For any A600.....£149.00

Evesham Micros SPECIAL HARD DISK UPGRADED MODELS

We are now able to supply Amiga A600's with larger hard disks. We take a single drive A600 and install a high quality 2 1/2" IDE hard drive. All models are available with 2Mb RAM - please add £35.00

Please note the hard disk installation is not covered by on-site warranty

	60Mb	120Mb
STANDARD PACK	£479.99	£599.99
WWW PACK	£524.99	£644.99

AMIGA 1200

KickStart/Workbench 3.0 • Fast 68020 processor • AGA chipset • CPU/DMA expansion port • PCMCIA expansion slot

£379.99

UPGRADE YOUR OWN A600 TO HARD DISK

Bring the benefits of a Hard Disk installation to your existing Amiga 600 with our easy to fit upgrades.

60Mb £229.00

120Mb £359.00

NEW FROM Evesham Micros

A600 1MB RAM/CLOCK UPGRADE

UPGRADE YOUR NEW A600 TO 2Mb WITH THIS SIMPLE PLUG-IN MEMORY UPGRADE!

- Simply Plugs into the A600's trapdoor expansion area
- Increases total RAM capacity of A600 to 2Mb 'ChipRAM'
- RAM Enable / Disable Switch
- Battery-Backed Real-Time Clock

ONLY £39.99

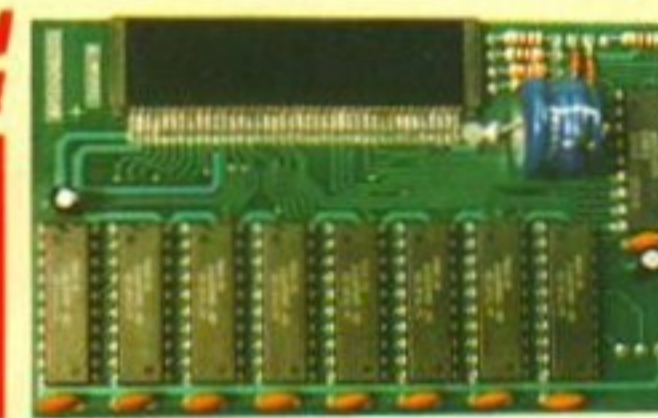

ROCGEN GENLOCKS

OFFERING EXCEPTIONAL VALUE FOR MONEY, the Roggen Genlocks offer levels of quality, function and sophistication not normally available in this price category.



SPECIAL OFFER! ROCGEN MK.II INCLUDES 'HOME TITLER' SOFTWARE FOR A500

GENLOCK MK.II ONLY £79.99 GENLOCK PLUS ONLY £119.99

PHILIPS 15" TV/MONITOR



With its dedicated monitor input, this model combines the advantages of a high quality medium resolution colour monitor with the convenience of remote control Teletext TV - at an excellent low price! Features dark glass screen for improved contrast, plus full range 3-way speaker sound output.

£269.00 Including VAT, delivery & cable

Philips CM8833 Mk.II Monitor (Genuine UK version), includes cable, 1 Year on-site maintenance and 'Lotus Esprit Turbo 2' game..... £ 229.00

ACCESSORIES

Add-on hard drive for A590 external cased unit with power supply	
40Mb	£ 249.00
100Mb	£ 399.00
MIDI Interface connects to serial port	£ 19.95
Virus Protector fits to last drive in system, protecting all drives	£ 6.95
VIDI-12 Amiga video digitiser package inc. VIDI-Chrome	£ 110.00
Amiga 500 Dust Cover	£ 4.95
Amiga 600 Dust Cover	£ 4.95

PROFESSIONAL AMIGA REPAIRS

Fixed rate repair service, includes disk drive faults.....£ 54.95

Please contact us on 0386-446441

Please note that we reserve the right to refuse any machine which is beyond economic repair

REPLACEMENT POWER SUPPLIES



Genuine Commodore Amiga A500 type replacement Power Supply Unit. Good quality 'switch mode' type. Super low price!

ONLY £39.95

Replacement Power Supply for A590 Hard Disk£ 49.95

3 1/2" EXTERNAL FLOPPY DRIVES

AMAZING LOW PRICE!

£47.99

including VAT & delivery

- Very quiet
- Slimline design
- Suits any Amiga
- Cooling vents
- Sleek, high quality metal casing

REPLACEMENT A500 INTERNAL 3.5" DRIVE KIT

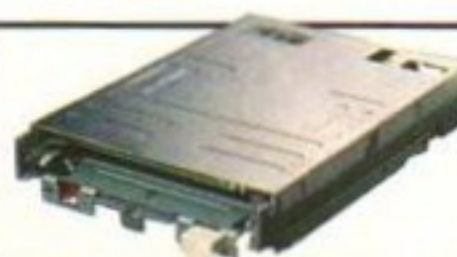

Fully compatible, with 1Mb unformatted capacity. Straightforward installation procedure. Kit includes full fitting instructions.

ONLY £39.99

WIN
£2,200
 WORTH OF
 KIT

Did you read the review of the OKI OL400 laser-quality printer in **Amiga Format** 43? Well if you did, then you'll know that we think it's the best thing since bread that's been sliced and put into a polythene wrapper. If you didn't read the review (and why not?) then don't worry, because we're giving you the chance to win, courtesy of OKI, two of these rather special pieces of kit worth £2,200! Now, if you've been promising yourself a decent printer, or even just a printer, then get your head round these questions in...



The Grand Amiga Format Win an OKI OL400

"The OKI OL400 is a well-designed and good-looking printer that brings you quality results at inexpensive prices. Not only is it cheap to buy, it's also pretty cheap to run too." This is the verdict given by Jason Holborn in his review of the OL400 which appeared in the February issue of **Amiga Format**.

This month, two of our lucky readers have the chance to win an OL400 laser quality LED printer.

The entire OKI page printer range centres around LED (Light Emitting Diode) technology, which offers benefits over laser printers in terms of greater reliability. This is because there are fewer moving parts and the print quality is better. OKI are so confident of the reliability of this system that they give a five-year guarantee on the LED printhead.

Another big advantage of the Oki OL400 is the

incredibly low price of the toner cartridge – instead of the usual £70 plus that you find with most laser printers, a toner cartridge for the OL400 LED will only set you back a mere £20, which will mean you'll save a considerable amount during the lifespan of the printer.

If you fancy one of these excellent machines sat on your desk next to your Amiga, and it would look very nice – as well as being massively useful – all you have to do is answer the 10 questions printed on the page to the right. Then write your answers on a postcard, along with your name, address and a daytime telephone number, stick a stamp on it and bung it to us by Her Majesty's mail.

We'll be drawing the winners on March 18, who then will be notified shortly thereafter. So get your entries in, and good luck!





Quiz for March 00 printer

HOW TO ENTER

Simply write down the answers to all 10 questions on the back of a postcard or stuck-down envelope along with your name and address, then send it to

Grand Quiz March,
Amiga Format,
29 Monmouth Street,
Bath,
BA1 2DL

to reach us before March 18. You can enter as many times as you like provided that each entry is posted separately. Please do not include entries with any other correspondence to the magazine; the competition address is different from our normal address.

THE RULES

Employees of Future Publishing, OKI Systems (UK) Ltd and extra-terrestrials stranded on Earth after a spacecraft crash are not allowed to enter.

Entries will be drawn from a hat after the date of closing and the first two correct entries will win. The judges' decision is final and no correspondence will be entered into. No cash or other alternative prizes will be offered, but we reserve the right to offer prizes of an equivalent value if the prizes named are unavailable.

OKI
People To People Technology

- 1** What does LED stand for?
- 2** How many years is the LED printhead in an OKI OL400 printer guaranteed for?
- 3** What score did *Amiga Format* award the OKI OL400 in Issue 43?
- 4** *The Gutenberg Bible* is a famous landmark in the history of printing, how many lines is it famous for having?
- 5** Which company prints *Amiga Format*?
- 6** What part of the body is covered in Whorls and Loops?
- 7** Which diminutive US pop star has a backing group called the New Power Generation?
- 8** What type of collectable Japanese goldfish has a name which is an anagram of OKI?
- 9** What does dpi stand for?
- 10** What record was Number One in the British charts on the 1 January 1990?

MJC COMPUTER SUPPLIES

Suppliers of Discount Software since 1984

Educational, Local Authority and government orders welcome. European orders please call or write for a quotation. All goods subject to availability, prices subject to change without notice. E&OE.

Prices include VAT and delivery by post.
Courier delivery available on request.
Please allow 5 days for cheque clearance.

TO ORDER: Credit card orders can be placed by calling the telephone number below - or send a cheque/PO's made out to MJC Supplies to:

MJC SUPPLIES (AF)
Unit 2 The Arches, Icknield Way,
Letchworth, Herts. SG6 1UJ.
Tel: (0462) 481166 (6 lines)

AMIGA COMPUTERS

NEW - AMIGA 1200

The very latest Amiga computer - now offers twice the processing speed at 14.9Mhz, 2 Mbyte of Chip Ram as standard, the new AA enhanced chip set offering up to 16 million colours, a full 96 keys with numeric keypads, Workbench 3.0 and 12 months On-site warranty.

MJC PRICE £CALL

(price includes free courier delivery)

AMIGA 600

The "portable" Amiga, features surface mount technology for greater reliability and Workbench 2. Comes complete with 12 months On-site warranty.

AMIGA 600 £259.00

AMIGA 600 & ZOOL GAMES PACK £275.00

(price includes free courier delivery)

AMIGA 600 HD EPIC PACK

Amiga 600 with the choice of a 20 or 40 Mbyte genuine Commodore hard drive fitted. The Epic pack comes complete with four games, Deluxe Paint 3 and an Amiga Easy Text Word Processor.

AMIGA 600 EPIC PACK WITH 20 MBYTE HARD DISK £359.95

AMIGA 600 EPIC PACK WITH 40 MBYTE HARD DISK £399.95

(price includes free courier delivery)

PLEASE NOTE:- All the above computers are genuine UK models with nothing taken out of the packs. All come with 12 months On-site warranty and free courier delivery.

AMIGA STARTER PACK

Includes:- 10 disks, 40 capacity disk box, Joystick, Dust cover and Mouse mat.

MJC PRICE £19.95

(Or just £15.95 if purchased with an Amiga)

AMIGA 600 CONTROL CENTRE

Manufactured by Premier Micros these are made of sheet steel and epoxy coated to exactly match the 600. They are precision made to fit the 600 and offer a perfect base for a monitor and a shelf for your extra disk drive or peripherals.

MJC PRICE £34.95

(Or just £29.95 if purchased with an Amiga 600)

A600 1 MEGABYTE EXPANSION

Increase your memory to 2 Mbyte.
Includes Clock.

MJC PRICE £44.95

(Or just £39.95 if purchased with an A600)

EDUCATIONAL SOFTWARE

THE FUN SCHOOL RANGE

Probably the best selling educational software for the Amiga. Fun School 3 and 4 also conform to the National Curriculum

Fun School 3 for Under 5	£15.95
Fun School 3 for 5-7 years	£15.95
Fun School 3 for Over 7	£15.95
Fun School 4 for Under 5	£15.95
Fun School 4 for 5-7 years	£15.95
Fun School 4 for Over 7	£15.95

FUN SCHOOL SPECIALS

In response to consumer demand a range of FUN SCHOOL SPECIALS have been developed to help children with specific areas of learning.

Merlin's Maths	£17.95
Spelling Fair	£17.95
Paint and Create	£17.95

LAUGH AND LEARN WITH ADI

The ADI series is aimed at being fun to use as well as being a serious educational tool. Each package is specifically designed to follow the National Curriculum for a particular school year.

ADI - English 11/12 years	£17.95
ADI - English 12/13 years	£17.95
ADI - English 13/14 years	£17.95
ADI - Maths 11/12 years	£17.95
ADI - Maths 12/13 years	£17.95
ADI - Maths 13/14 years	£17.95
ADI - Maths 14/15 years	£17.95
ADI - French 11/12 years	£17.95
ADI - French 12/13 years	£17.95
ADI - French 13/14 years	£17.95
ADI - French 14/15 years	£17.95

KOSMOS SOFTWARE

Kosmos software produce a superb range of educational software including the Answerback Quiz programs and four foreign language aids as well as the hugely popular Maths Adventure.

Answerback Junior Quiz (6-11 years)	£14.95
Answerback Senior Quiz (12 to Adult)	£14.95
Factfile Spelling (requires Junior Quiz)	£7.95
Factfile Arithmetic (requires Junior Quiz)	£7.95
French Mistress	£14.95
German Master	£14.95
Spanish Tutor	£14.95
Italian Tutor	£14.95
Maths Adventure	£17.95

LCL SOFTWARE

Primary Maths Course (3-12 years)	£18.95
Micro Maths (GCSE Level)	£18.95
Micro French (GCSE Level)	£18.95
Micro English (GCSE Level)	£18.95
Micro German (GCSE Level)	£18.95
Reading & Writing Course (3 years+)	£18.95

COOMBE VALLEY SOFTWARE

This is a range of excellent educational adventure games for various ages.

Maths Dragons (5-12 years)	£12.95
Cave Maze (8-13 years)	£12.95
Reasoning With Trolls (5-12 years)	£12.95
Fraction Goblins (8-13 years)	£12.95
Picture Fractions (7-10 years)	£12.95
Tidy The House (5-9 years)	£12.95

NODDY'S PLAYTIME

A complete entertainment and learning package for young children. Contains 10 exciting programs which include a full Junior Art package, Noddy's Paint Pot, Post Office, Market Place and many more. (1 Mbyte Required)

MJC PRICE £18.95

AMIGA SERIOUS SOFTWARE

AMOS - THE CREATOR

Easy Amos - Simple but powerful	£22.95
Amos v1.2 The original language	£31.95
Amos Compiler	£19.95
Amos 3-D	£21.95

NEW - AMOS PROFESSIONAL

An enhanced version of the very popular Amos program. Contains over 200 new commands. 650 page brand new manual and many more new features.

MJC PRICE £44.95

MINI OFFICE AMIGA

Great new integrated package featuring a Word Processor, Database, Spreadsheet, Graphics and Disk Utilities.

MJC PRICE £39.95

VIDI AMIGA 12

Vidi Amiga 12 is the latest low cost colour digitiser from Rombo. RGB Splitter is built in and colour images can be captured in less than a second. Mono images are grabbed in real time. Features multi tasking software, composite or S-VHS input, HAM, EHB and overscan.

MJC PRICE £75.95

NEW - CLARITY 16

The first low cost 16 bit stereo sampler for the Amiga. Contains an Editor, Midi Functions, Sequencer and Realtime Special Effects.

MJC PRICE £105.00

WORD PROCESSORS

Wordworth V2	£74.95
Protex V4.3	£39.95
Pen Pal V1.4	£37.95
Kindwords 3	£32.95

NEW - VIDEOMASTER

Videomaster combines a Video Digitiser and a Sound Sampler in one low cost unit. Digitise monochrome quarter screen pictures at speeds up to 25/30 frames per second. Can digitise in colour using filters supplied or an additional RGB splitter (not provided). Record sound tracks using the Sound Sampler to create your own short films or demos. (Amiga 500/500+ Only)

MJC PRICE £49.95

MISCELLANEOUS

Pro Midi Interface	£19.95
Stereo Master	£29.95
Rombo Megamix Master	£28.95
Rombo Take 2	£39.95
Hisoft Devpac 3	£49.95
Hisoft Highspeed Pascal	£69.95
Final Copy 2	£65.95
Deluxe Paint V4.1	£54.95

FINANCIAL

Home Accounts 2	£36.95
Personal Finance Manager Plus	£29.95
Maxiplan 4	£34.95

AMIGA ACCESSORIES & ADD-ONS

ACTION REPLAY Mk3

MJC PRICE £54.95

NAKSHA UPGRADE MOUSE

280 DPI quality replacement mouse - Pack includes Mouse House, Mat and Operation Stealth game.

MJC PRICE £22.95

ZYDEC SECOND DISK DRIVE

Excellent value external drive for the Amiga. Includes free Virus X Utility.

MJC PRICE £52.95

ROBOSHIFT

Auto sensing joystick/mouse switch box.

MJC PRICE £13.95

SQUICK REPLACEMENT MOUSE

Great value replacement mouse.

MJC PRICE £12.95

VISA

Remember - prices include VAT & delivery!

Access

From the makers of Fun School comes ADI – 'edutainment' for the over 10s. **Gary Lord** finds out whether it's more fun than school...

EUROPRESS SEEM TO have the market cornered in the education market with their excellent *Fun School* programs. These are divided up into three sub-categories, for children of different ages and abilities, though the oldest age group they go up to is 10.

It's about time then, that Europress put their talents into providing some sort of educational instruction for the over 10s, which is precisely what they've done with their new ADI packages. Instead of cute little bear and frog characters to base educational exercises around, this time they've picked an alien as their central character. His name is, aptly, Adi, and he is millions of years old and used to live on an asteroid.

The Adi character is probably fine for the younger age group (11-13), but for the older age set, Adi and the way the programs are set up is probably a bit too juvenile. The 13/14 age ADI programs certainly seem to be an afterthought as far as the ADI interface is concerned. There is no difference between the two programs in character and format, apart from the fact that the educational content is more advanced. The *Fun School* series, though, has different characters to suit the growing child, starting with a Teddy for the younger ages, and Sammie the Spy for the older ones.

Each ADI program comes on two separate disks. The first is a loading disk in which Adi introduces himself, and you introduce yourself to him. He then goes on to explain how the menu bar at the bottom of the screen works. The second disk is the application disk which contains all the exercises. When you load the application you are presented with a scene-setting picture, and as you point the cursor at different subjects and objects in the picture, various topics appear. You then click on the topic that you wish to study and another picture comes up with various sub-sections.

Adi is there to reward you with various sentences such as "Yo dude you're really on form today", which I imagine most 14-year-olds will tire of sooner or later. Questions are asked and you either type in the answers or click on the right reply with the mouse. If you're somewhat bemused by any particular topic then help is always at hand by just clicking on the 'Help' icon. So if you're not to sure

Adi is your guide through some maths tuition. The category chosen is Pythagoras. Do well and your score will increase and Adi will reward you with a game or two.



ADI Education Software

French/Maths/English ■ £25.99 each ■ Europress

about whether 'i' comes before 'e', or where your speech marks and commas should go, then 'teacher' is there to help.

Some questions are based on the 'Read Me' document which can be accessed by just clicking on it. If you get the answer correct, a small animation, for example a man walking over a rickety bridge, will be displayed at the bottom of the screen. If you get the answer wrong the same animation will play, but something will go drastically wrong – ie the bridge will collapse as he walks across it.

Accumulation of points is the object of the exercise. The more exercises you complete correctly, then the more points you get. And what do points make? Prizes? Not quite. They make games, of the early arcade variety. In fact the exact same games that are in the preceding ADI programs. Whether students will persevere with the program to gain enough points to win all 10 games, or whether they'll become bored and simply insert the latest Ocean shoot-em-up is another matter.

Educationally, the programs have plenty of content, although I can't see a great deal here which is going to make French, Maths and English much more interesting than plain old pens, paper and text books. The programs don't push the Amiga to its limits – it's the same-looking screen whatever subject or age range you're dealing with. There is one nice little touch though. If you get the wrong answer repeatedly, Adi tells you to have a break. When you return, you discover him having forty winks, and you wake him up as soon as you touch the keyboard.

This doesn't mean that this program isn't worth splashing out on. With plenty of exercises, the student can go at their own pace and concentrate on areas that they find difficult without needing a teacher on-hand.

ADI 13/14 is available from Europress 0625 859333

ADI – WHERE THERE'S TIME FOR WORK AND PLAY



The English disk covers basic spelling and some excellent English comprehension exercises.



The French disk covers material that you would use on a holiday to France, but retains a high educational content.



One of the 10 games that ADI rewards students with. They are fairly basic, but fun, and are an incentive to carry on.

ADI EDUCATION

SPEED ●●●●

Once you're in an application then it is quite quick. The usual pain with loading though.

DOCUMENTATION ●●●●

Comprehensive instruction manual, but nothing to add to the educational content.

ACCESSIBILITY ●●●●

Very easy to access the programs, and a very friendly interface.

FEATURES ●●●●

Nothing particularly new here, and the format probably suits a younger age group.

VALUE ●●●●●

Polished software, and probably worth it if it keeps your kids off the games for a while.



75 %

Ladbroke Computing



33 Ormskirk Rd,
Preston, Lancs,
PR1 2QP

Ladbroke Computing International are one of the longest established home computer dealers in the UK. We have developed an extensive customer service policy which involves testing of all Hardware prior to despatch to ensure that goods arrive in working order, offering free advice and support over the phone and keeping customers informed. Although our prices are not always the cheapest we do endeavour to offer consistently good service and backup.

All prices are correct at copy date 14/1/93 (while stocks last), and are subject to change without prior notice. All prices include VAT but exclude delivery.

How to Pay

You can order by mail Cheques/Postal orders made payable to Ladbroke Computing. Or give your credit card details over the phone.

Delivery

Add £3 for postal delivery (check with staff before ordering)

Add £7 for next working day courier delivery. Add £11 for Saturday courier delivery. (Mainland UK only)

Open Mon-Sat 9:30am to 5:00pm.
Ladbroke Computing Ltd Trading As
Ladbroke Computing International

Fax: (0772) 561071

Tel: 9 am - 5:30 pm (5 Lines)

(0772)203166

Printers



Star	
Star LC20	£ 124
Star LC100 colour	£ 165
Star LC24/100	£ 179
Star LC24/200 colour	£ 259
Starjet SJ48 Bubblejet	£ 210
SJ48 Sheetfeeder	£ 69

Citizen

Citizen Swift 240 Colour	£ 270
--------------------------	-------

Hewlett Packard

HP Deskjet 500	£ 339
HP Deskjet 500 colour	£ 449

Lasers

Seikosha OP104	£ 549
----------------	-------

- 512K RAM (Exp to 2.5Mb)
- HP Laserjet IIP emulation
- 14 resident fonts
- 12 months on site warranty

Ricoh LP1200	£ 759
--------------	-------

- Fully HP III compatible
- 400Dpi resolution
- 2Mb RAM on board
- Serial & Parallel ports
- 12 months on site warranty

All Star dot matrix printers come complete with 12 months on site warranty. Please add £3 for Centronics cable.

Hand Scanners



- 100,200,300,400 Dpi resolutions.
- 1 letter mode, 3 photo modes.
- Includes two of the most respected graphics packages, MIGRAPH'S TOUCH UP and DELUXE PAINT III.

Golden Image Scanner	£ 99.99
Jin Scanner	£ 89.99
Jin as above but excluding Touch Up.	

GVP II Hard drives

- Quantum SCSI Hard drive
- Ultra fast 11ms access
- Up to 8Mb RAM on board
- Disable switch
- 2 year warranty

52Mb No RAM	£ 329
52Mb 2Mb RAM	£ 369
52Mb 4Mb RAM	£ 429
120Mb No RAM	£ 439
120Mb 2Mb RAM	£ 479
120Mb 4Mb RAM	£ 529
120Mb 8Mb RAM	£ 649
2Mb SIMM upgrade	£ 48
4Mb SIMM upgrade	£ 93
8Mb SIMM upgrade	£ 180

Repair Services

Our Service department can repair Amiga's in minimum time at competitive rates. We can arrange for courier pickup and return delivery of your machine to ensure it's safety. We even have a same day service which will ensure your machine is given priority and subject to fault, completed the same day. We can fit memory upgrades, ROM upgrades. We offer a Quotation service for £15 for which we will examine your machine and report back with an exact price for repair. If you do not wish to go ahead with the repairs then just pay the £15. However if you do go ahead then the charge is included in the minimum charge. Please note: The minimum charge covers labour, parts are extra.

Quotation service	£ 15
Min repair charge	£ 35.25
Courier Pickup	£ 11
Courier return	£ 6
Same day service	£ 15
A500 PSU	£ 39.99
Internal drive	£ 39.99

Atari Falcon 030

The Falcon features: 16MHz 32 bit 68030 CPU, 16MHz Blitter, 32MHz DSP, 8 channel 16 bit CD quality sound chip, VGA resolution in 65536 colours, Multitasking TOS, Network port, 144Mb floppy, expandable to 14Mb RAM, Stereo microphone input for direct sound digitising, Stereo sound output.

Falcon 1Mb RAM	£ 479.99
Falcon 4Mb RAM 65HD	£ 879.99

Amiga 600 Packs

Amiga A600 £ 249.99
Includes: The new reduced size keyboard, internal modulator, 1Mb on board RAM, Workbench 2.05. Will take smart cards. Also includes 12 months on site Warranty.

Amiga 600 wild, wierd and wicked pack £ 299.99
Includes A600 with Pushover, Microprose Grand Prix, Silly Putty and Deluxe paint III.

A600HD Epic Pack £ 399.99
Includes A600 with 20Mb internal hard drive and Epic, Trivial Pursuit, Rome Myth.

A500 Plus Cartoon Classics £ 274.99
Special Offer while stocks last.

A500 Class of the 90's £ 434.99
Special Offer while stocks last

Mini Office £ 45
Wordprocessor, Database, Spread sheet, Disc Utilities and Graphics.

Compendium Six £ 29.99
A Pack of 6 educational games to encourage creative learning in Maths, Science, Geography and English.

Mice



Golden Image Mouse £ 14.99
The Golden Image Mouse was recently given an Amiga Format Gold Award with 90% and offers 290 Dpi resolution, 2 high quality microswitched buttons and a free mouse mat.

Optical Mouse £ 24.99
The Golden Image Optical Mouse is a high quality, 3 button, replacement mouse. The fully Optical mechanism means no moving parts offering far higher reliability. Includes Mat.

Jin Mouse £ 7.99
Don't be deceived by the low price of this mouse. Mass production of the Jin mouse has resulted in a high quality Opto/Mechanical mouse featuring 290 Dpi resolution.

Ladbroke's Mouse mat £ 2.98
Please add £2 for P&P on mice.

Floppy Drives



- 880K formatted capacity
 - Double sided, Double density
 - Through port
- | | |
|----------------------|---------|
| GI External drive | £ 47.99 |
| Amiga internal drive | £ 49.99 |

GI Brush Mouse



"The Natural way to draw"

- 150Dpi resolution
- Opto/Mechanical mechanism
- 500mm/SEC tracking speed
- Switchable between Amiga/ST
- Direct Mouse replacement.

GI Brush Mouse	£ 19.99
GI Brush + Dpaint III	£ 24.99

RAM Upgrades

A500 512K with clock £ 17.99
The golden image 512K RAM upgrade includes battery backed clock and enable/disable switch.

Xtra RAM A500 + 1Mb £ 49.99
The Xtra RAM for the A500 Plus only, adds 1Mb of chip RAM to the A500 Plus.

A600 Amitek 1Mb with clk £ 42.99
Plugs straight into A600 trap door, compatible with A600, A600HD.

Accessories

50 3.5" disks	£ 20
100 3.5" Disks	£ 38
3.5" Disk head cleaner	£ 4
40 disk box	£ 4.99
80 disk box	£ 7.99
150 Disk box	£ 17.99
A500 Dustcover	£ 3.99
Mouse J/S extension	£ 5.99
PRO Star Mini joystick	£ 14.99

Monitors



Philips 8833MKII £ 229.99
This best selling colour, stereo monitor comes complete with 12 months on site warranty and free Lotus Turbo challenge II.

Philips 15" FST Tv £ 219.99

- SCART input Tv
- 39 channel remote control
- Flat Screen

Philips 15" Cube Teletext £259.99

- SCART input Tv
- 60 channel remote control
- Fasttext teletext
- Flat Screen
- 3 Speaker sound

8833 MKII-Amiga cable	£ 9.99
Philips SCART to Amiga	£ 9.99
8833MKII dustcover	£ 7.99
14" Monitor stand	£ 9.99



CREDIT CARD HOTLINE:

081 889 9172

ENQUIRY/ORDER LINE:

081 361 5730

24 HOUR FAX LINE

081 361 2733

**118a Palmers Road
New Southgate
LONDON N11 1SL**

BITMAP BROTHERS VOL 1 only £16.99 Xenon, Cadaver and Speedball II	DREAM TEAM only £16.99 Terminator II, Sim Poon, W.W.F.	RAVING MAD only £18.99 Mega twins, Rodland, Robocod
CHAMPIONS only £13.99 Jahangir Khan Squash, Man United and W.C. Boxing Manager	SOCCER MANIA only £11.99 Football Manager II, Gazza's Soccer, Football Manager - W.C. Edition, Microprose Soccer	POWER PACK II only £17.99 Predator II, Battle Master, Wings, It Came From The Desert
BIG BOX only £15.99 Captain Blood, Tin Tin on the Moon, Safari Guns, Teenage Queen, Bubble Plus, Purple Saturn Days, Krypton Egg, Jumping Jackson, BoBo, Hostages	TEST DRIVE II COLLECTION only £20.99 Muscle Cars, California Challenge, European Challenge, Duel, Super Cars	BIG BOX II only £19.99 Back to the Future III, R-Type, IK+, Real Ghostbusters, Def of the Earth, TV Sports Football, Shanghai, Armalyte, Sinbad, Bombozal
BOARD GENIUS only £17.99 Deluxe Monopoly, Deluxe Scrabble, Cleudo Master Detective and Risk	4 WHEEL DRIVE only £19.99 Lotus Esprit, Celica GT4 Rally, Team Suzuki, and Combo Racer	POWER PACK only £14.99 Xenon 2, TV Sports Football, Bloodwych and Lombard Rally
HOLLYWOOD COLLECTION only £18.99 RoboCop, Ghostbusters 2, Indiana Jones, Batman the Movie	RAINBOW COLLECTION only £13.99 New Zealand Story, Bubble Bobble, Rainbow Islands	COMBAT CLASSICS only £20.99 F15 Strike Eagle II, 688 Attack Sub and Team Yankee
MAX EXTRA only £17.99 Turrican II, ST Dragon, SWIV and Night Shift	NINJA COLLECTION only £13.99 D. Dragon, Shadow Warrior, D. Ninja	BITMAP BROS VOL 2 * only £16.99 Xenon II, Speedball II, Gods, Magic Pockets
SUPER HEROES only £17.99 Strider II, Indiana Jones, Last Ninja II and Spy who loved me	AWARD WINNERS ONLY £16.99 Kick Off II, Pipemania, Space Ace and Populous	2 HOT 2 HANDLE only £18.99 Golden Axe, Total Recall, Shadow Warrior, Super Off Road Racing
STRATEGY MASTER only £21.99 Deusteron, Populous, Hunter, Chessplayer 2150 and Spirits of Excalibur	SUPER FIGHTER only £16.99 PFighter, W.W.F., Final Fight	MEGA MIX only £19.99 Leader, Agony and Ork
DIZZYS EXCELLENT ADVENTURES only £16.99 Dizzy Panic, Bubble Dizzy, Dizzy Prince of York Folk, Spellbound Dizzy and Kwik Snak	ACTION MASTERS only £14.99 Turbo Outrun, F16 Combat Pilot, Italy 1990, Welltris and Double Dragon II	SPORTS COLLECTION only £12.99 Run the Gauntlet, Pro Tennis Tour and World Cup Soccer (Italia '90)
SPORTS MASTERS only £19.99 PGA Tour Golf, Indy 500, Advantage Tennis, and European Championship 1992	ACTION PACK only £12.99 Cosmic Pirates, Rotor, Maya, On Safari, Eliminator, Fast Lane, Sherman M4, Hostages, Targlan and Colorado	ACTION 5 only £19.99 Rick Dangerous II, Ghostbusters II, Gunship, Super Ski and Hard Driving

TOP TITLES	AMIGA	TOP TITLES	AMIGA	TOP TITLES	AMIGA
A500+ 1Meg Upgrade	£39.99	Deliverance	£15.99	Knight Mare + Hint Book	£19.99
A600 1Meg Upgrade + clock	£49.99	Desert Strike	£16.99	Knight of the Sky	£23.99
0.5 Meg Upgrade + clock	£25.99	D/Generation	£11.99	Lawn Mower Man *	£16.99
3D Construction Kit II	£36.99	Disciples of Steel	£17.99	Leander	£15.99
4D Sports Boxing	£11.99	Doodlebug	£16.99	Leathal Weapon	£16.99
4D Sports Driving	£11.99	Double Dragon III	£16.99	Leeds Utd	£12.99
A-Train	£23.99	Dreadnoughts	£22.99	Legend + Hint Book	£19.99
Action Stations	£12.99	Dune	£19.99	Legend of Kyrandia	£20.99
Addams Family	£16.99	Dune II *	£19.99	Legends of Valour	£23.99
Agony	£15.99	Dungeon / Chaos	£19.99	Leisure Suit Larry II	£14.99
Air Combat Patrol	£19.99	Dyna Blast	£20.99	Leisure Suit Larry III	£19.99
Air Support	£15.99	Elf	£15.99	Leisure Suit Larry V	£26.99
Aliens III *	£16.99	Elvira II - Cerberus	£23.99	Lemmings	£15.99
A. Maclean's Pool	£16.99	Epic	£19.99	Lemmings and Data Disk	£19.99
AMNIO	£12.99	Eye of the Beholder	£19.99	Lemmings II	£21.99
Amos (Easy)	£23.99	Eye of the Beholder II	£23.99	Lemmings - Data Disk	£13.99
Amos 3D	£23.99	F14 Tom Cat *	£18.99	Lemmings - Stand Alone	£15.99
Amos Compiler	£19.99	F15 Strike Eagle II	£23.99	Life and Death II	£20.99
Amos Professional	£54.99	F117A Stealth Fighter *	£21.99	Links HD	£23.99
Amos The Creator	£36.99	F19 Stealth Fighter	£19.99	Liquid Kids *	£16.99
Another World	£17.99	F29 Retaliator	£15.99	Lost Patrol	£15.99
Aquatic Games star J Pond	£16.99	Face Off - Ice Hockey	£15.99	Lost Treasures of Infocom	£29.99
Aquaventura	£13.99	Falcon	£11.99	Lotus Turbo Challenge II	£16.99
Arabian Nights	£16.99	Falcon Mission Disk I	£8.99	Lotus Turbo Challenge III	£16.99
Armourgeddon	£15.99	Falcon Mission Disk II	£8.99	Lure of the Temptress	£19.99
Armourgeddon Upgrade *	£10.99	Falcon 3.0	£23.99	M1 Tank Platoon	£16.99
Ashes of Empire	£20.99	Fantastic Voyage	£16.99	Magic Pockets	£15.99
Assassin	£16.99	Fate of Atlantis (Adv)	£25.99	Man Utd. Europe	£15.99
A.T.A.C. *	£23.99	Fate of Atlantis (Arc)	£16.99	M. Dika Ultimate Football *	£18.99
B17 Flying Fortress *	£23.99	Final Blow	£16.99	Mega Fortress	£16.99
Bane of the Cosmic Forge	£24.99	Final Fight	£16.99	Mega Sports	£16.99
BARBARIAN II (Psyq)	£14.99	Fire and Ice	£15.99	Megatraveller II	£20.99
Bards Tale Trilogy	£19.99	First Samu/MegaLoMan	£20.99	Merchant Colony	£16.99
Bart vs the World *	£16.99	FireStone HD Scenery	£13.99	Microprose Golf	£23.99
B.A.T. II	£22.99	Flashback *	£16.99	Midwinter II	£23.99
Battle Chess II	£16.99	Flight of the Intruder	£11.99	Mig 29 Fulcrum	£16.99
Battle Isle	£18.99	Football Crazy	£14.99	Might of Magic III	£23.99
Battle Isle Data Disc	£13.99	Football Manager III	£14.99	Moonstone	£19.99
Battle Toads	£16.99	Free DC	£18.99	Monkey Island	£15.99
BC Kid	£16.99	Gauntlet III	£12.99	Monkey Island II	£25.99
Big Run	£12.99	Global Effect	£16.99	Mouse (Switchable)	£9.99
Birds of Prey	£23.99	Goblins II	£19.99	Myth	£18.99
Black Crypt	£16.99	Gods	£16.99	Nick Faldo Golf	£23.99
Blue Max	£11.99	Golden Shot	£16.99	N. Mansell World Champ	£20.99
Buck Rogers	£19.99	G. Gooch Cricket	£21.99	Noddys Playtime	£16.99
Buck Rogers II	£20.99	Graham Taylor	£15.99	ORBITUS	£12.99
Cadaver	£11.99	Grand Prix (Formula)	£23.99	Ork	£15.99
Cadaver - the pay off	£10.99	Gunship 2000	£23.99	Outlanders *	£16.99
Caesar	£16.99	Guy Spy	£20.99	Pacific Islands - T.Yankee II	£20.99
Campaign	£22.99	Harlequin	£16.99	Parasol Stars	£15.99
Captive	£15.99	Harpoon (1 Meg)	£19.99	Perfect General	£20.99
Captive II *	£17.99	Harrier Assault AV8B	£23.99	PGA Golf Tour *	£20.99
Carl Lewis Challenge	£15.99	Heimdall	£23.99	PGA Courses Disk	£10.99
Castles	£16.99	Hero's Quest (Grem)	£16.99	Pinball Dreams	£15.99
Castles Data Disc	£11.99	Hill Street Blues	£15.99	Pinball Dreams II	£16.99
Castle of Dr Brain	£15.99	Historyline 1914-18	£16.99	Populous II - The Challenge	£11.99
Chaos Engine	£16.99	Home Alone	£23.99	Populous II + (1 Meg)	£23.99
Chase HQ II	£14.99	Home Alone Colouring Book	£14.99	Premiere	£20.99
Chuck Rock II *	£16.99	Hook	£15.99	Premier Manager	£16.99
Civilisation	£23.99	Humans	£19.99	Project X	£16.99
C.Y.'s Air Combat	£20.99	I. Bothams Cricket	£19.99	Push Over	£15.99
Cool Croc Twins	£16.99	Indy Heat	£16.99	Putty	£16.99
Cool World	£16.99	International Sports Chall.	£15.99	QUEST AND GLORY	£16.99
Combat Air Patrol	£18.99	Ishar - Legend Fortress	£20.99	Railroad Tycoon	£23.99
Conflict Korea	£23.99	Jaguar XJ220	£16.99	Reach for the Skies	£20.99
Contraptions *	£16.99	James Pond III (Op Starfish)	£16.99	Red Baron	£15.99
Cover Girl Poker	£16.99	Jim Power *	£16.99	Red Zone	£15.99
Covert Action	£23.99	J. White's Whirlwind	£16.99	Rise of the Dragon	£15.99
Crazy Cars III	£16.99	J. Barnes (1 Meg)	£15.99	Risky Woods	£16.99
Cruise for a Corpse	£17.99	J. Madden's Football	£16.99	Road Rash	£16.99
Crystal Kingdom Dizzy	£13.99	KGB	£20.99	Robin Hood	£16.99
Curse of the Enchanter	£23.99	Kick Off II (1 Meg)	£15.99	Robocod	£15.99
Cytron	£19.99	Kick Off III (.5 Meg)	£14.99	Robocop III	£16.99
Dalek Attack	£12.99	Kick Off III *	£16.99	Robo Sports	£20.99
Darkmere	£16.99	Kid Gloves II	£16.99	Rod Land	£16.99
Das Boot	£11.99	Kings Quest V	£15.99	Rookies *	£17.99

TOP TITLES	AMIGA	TOP TITLES	AMIGA	TOP TITLES	AMIGA	TOP TITLES	AMIGA	EDUCATIONAL	
R-Type II	£14.99	Test Drive III	£15.99	ADi English 11-12	£16.99	ADi English 12-13	£16.99	ADi English 12-13	£16.99
Sabre Team	£16.99	The Games '92 Espana	£20.99	ADi English 13-14	£16.99	The Manager	£20.99	ADi English 13-14	£16.99
Savage Empire	£22.99	Their Finest Hour	£19.99	ADi French 11-12	£16.99	ThunderhawkAH-73M	£21.99	ADi French 12-13	£16.99
Secret Silver Blues	£21.99	The Manager	£20.99	ADi French 13-14	£16.99	Thunder Jaws	£16.99	ADi Maths 11-12	£16.99
Secret Weap Luft *	£19.99	ThunderhawkAH-73M	£21.99	ADi Maths 12-13	£16.99	Tip Off	£16.99	ADi Maths 12-13	£16.99
Sensible Soccer 92-93	£16.99	Thunder Jaws	£16.99	ADi Maths 13-14	£16.99	Toon World *	£15.99	ADi Maths 13-14	£16.99
Shadowlands	£19.99	Tip Off	£16.99	ADi Maths 14-15	£16.99	Troddlers	£16.99	ADi Maths 14-15	£16.99
SHADOW BEAST II	£12.99	Toki	£15.99	ADi Maths 15-16	£16.99	Troops	£16.99	Better Spelling 8-14	£14.99
Shadow of the Beast III	£19.99	Toon World *	£15.99	Better Spelling 8-14	£14.99	TV Sports Baseball	£11.99	Better Maths 12-16	£14.99
Shadow Worlds	£16.99	Troddlers	£16.99	Fun School 2 under 5	£6.99	TV Sports Boxing	£11.99	Fun School 2 under 5	£6.99
Shuttle the Sim	£20.99	Troops	£16.99	Fun School 2 over 6	£6.99	TV Sports Golf	£11.99	Fun School 2 over 6	£6.99
Silent Service II	£23.99	Turtles II	£11.99	Fun School 3 under 5	£6.99	Ugh!	£15.99	Fun School 3 under 5	£6.99
Sim Ant	£22.99	Ugh!	£15.99	Fun School 3 over 6	£6.99	Ultima V	£19.99	Fun School 3 over 6	£6.99
Sim Earth	£23.99	Ultima V	£19.99	Fun School 4 under 5	£6.99	Ultima VI	£20.99	Fun School 4 under 5	£6.99
Simpsons	£15.99	Ultima VI	£20.99	Fun School 4 5-7	£6.99	UMS II	£16.99	Fun School 4 5-7	£6.99
Sleepwalker *	£15.99	UMS II	£16.99	Fun School 4 7+	£6.99	UMS II Planet Editor *	£20.99	Fun School 4 7+	£6.99
Snow Bros	£16.99	UMS II Planet Editor *	£20.99	Junior Typist	£11.99	Universal Masters	£16.99	Junior Typist	£11.99
Soccer Kid	£16.99	Universal Masters	£16.99	Magic Maths (4-8)	£14.99	Uridium II *	£17.99	Magic Maths (4-8)	£14.99
Soup Trek *	£16.99	Uridium II *	£17.99	Maths Mania	£14.99	Utopia	£16.99	Maths Mania	£14.99
Space 1889	£16.99	Utopia	£16.99	Noddy's Playtime	£16.99	Utopia New World	£11.99	Noddy's Playtime	£16.99
Space Ace II	£33.99	Utopia New World	£11.99	The Three Bears	£14.99	Video Kid	£15.99	The Three Bears	£14.99
Space Gun	£12.99	Video Kid	£15.99	3.5 DS DD discs with Labels boxed in 10's		Viking Fields of Conquest	£15.99	10 x 3.5 DS DD	£5.99
Space Crusade	£16.99	Viking Fields of Conquest	£15.99	20 x 3.5 DS DD	£11.99	Voyage Beyond (S.Crusade)	£16.99	30 x 3.5 DS DD	£15.99
Space Quest III,III, or IV	£23.99	Voyage Beyond (S.Crusade)	£16.99	50 x 3.5 DS DD	£21.99	Vroom	£16.99	100 x 3.5 DS DD	£39.99
Special Forces	£23.99	Vroom	£16.99	Please add 50p per 10 discs when ordering to cover P & P		Walker *	£18.99		
Steel Empire	£20.99	Walker *	£18.99			White Death (1 Meg)	£12.99	Pro Tennis Tour	£6.99
Stereo Master	£26.99	White Death (1 Meg)	£12.99			Wily Beamish	£15.99	Puzznic	£6.99
Storm Master	£16.99	Wily Beamish	£15.99			Wing Commander I	£19.99	Rainbow Islands	£6.99
Street Fighter II	£17.99	Wing Commander I	£19.99			Wiz Kid	£15.99	Rambo III	£6.99
Strike Fleet	£16.99	Wiz Kid	£15.99			W.W.F.	£15.99	RB2 Baseball	£6.99
Striker	£16.99	W.W.F.	£15.99			W.W.F. II	£15.99	Resolution 101	£6.99
Super Cauldron *	£16.99	W.W.F. II	£15.99			Zoo	£16.99	Rick Dangerous II	£7.99
Super SWIV *	£16.99	Zoo	£16.99					Robocod	£6.99
Supremacy	£18.99							Robocop II	£6.99
Sword of Honour	£16.99							Rolling Ronny	£9.99
Tear Away Thomas	£15.99							R-Type	£6.99
Tennis Cup 2	£16.99							Run The Gauntlet	£6.99

AMIGA BUDGET TITLES UNDER £10

3D Pool	£6.99	IK+	£6.99	Pro Tennis Tour	£6.99
Afterburner	£6.99	Impossible Mission II	£6.99	Puzznic	£6.99
Altered Beast	£6.99	Indy Last Crusade Graphic	£9.99	Rainbow Islands	£6.99
Arkanoid II	£6.99	James Pond	£6.99	Rambo III	£6.99
ATOMINO	£8.99	Jet Set Willy	£7.99	RB2 Baseball	£6.99
Barbarian	£5.99	J.Khan Squash	£6.99	Resolution 101	£6.99
Barbarian II	£6.99	Kid Gloves	£5.99	Rick Dangerous II	£7.99
Batman The Movie	£6.99	Last Ninja II	£6.99	Robocod	£6.99
Battheawks 1942	£9.99	Last Ninja III	£7.99	Robocop II	£6.99
Blood Money	£6.99	Lombard RAC Rally	£6.99	Rolling Ronny	£9.99
Cabal</					

Subscriptions



Make sure you get your hands on Amiga Format every month!

Demand is always high for the world's best Amiga magazine, so don't take a chance of missing the last copy on the news-stands. You can get every issue delivered to your door, a free piece of software and save money. All you need to do is subscribe, go on! You know it makes sense.

UK £38.95
 Europe £67.95
 Rest of world £97.45

AMIGA FORMAT

168

MARCH 1993

Back Issues



ISSUE 19 Beginners' special, explains how to care for your Amiga. **£4**
ISSUE 21 Paint programs: every single one tested and rated. **£4**
ISSUE 22 Samplers, scanners and digitisers can change your world. **£4**
ISSUE 25 DTP explained plus the massive round-up of the year. **£4**
ISSUE 27 True Colour brings 16 million colours to your screen. **£4**
ISSUE 29 First review of the A500 Plus, word processors tested. **£5**
ISSUE 33 Landscape program Vista, plus how to create cartoons. **£5**
ISSUE 35 Digitising and sampling. Plus Spectracolor Jr. **£5**



ISSUE 36 With the multimedia program CanDo! Jr and the full low-down on the A600 and the CD-ROM drive!! **£5**
ISSUE 37 The amazing story of musicians and artists who have made it big with an Amiga, plus Animation Station. **£5**
ISSUE 38 Got an A500? Learn how your machine can become a Super Amiga! Plus: choose a monitor from our guide and IntroCAD. **£5**
ISSUE 40 We give you all the hints and tips on how to get the most out of Deluxe Paint. Plus: TVText and CrossDOS. **£5**
ISSUE 41 The inside story on two new Amigas: the A4000 and A1200. Plus: complete word processor Scribble!. **£5**
ISSUE 42 The top 30 games of all time tipped. Plus: Complete AMOS language and Lemmings 2 Demo on the disk. **£5**
ISSUE 43 We take a look inside the Amiga and tell you 'How it Works'. On the coverdisk the full database ProData. **£5**

Sorry folks, but if you don't see it, we ain't got it! Amiga Format back issues sell out fast, so if you're thinking about buying a few of the issues you missed on the news-stand order them now, and save yourself a disappointment.

We will also give you the choice of any one of these great freebies...

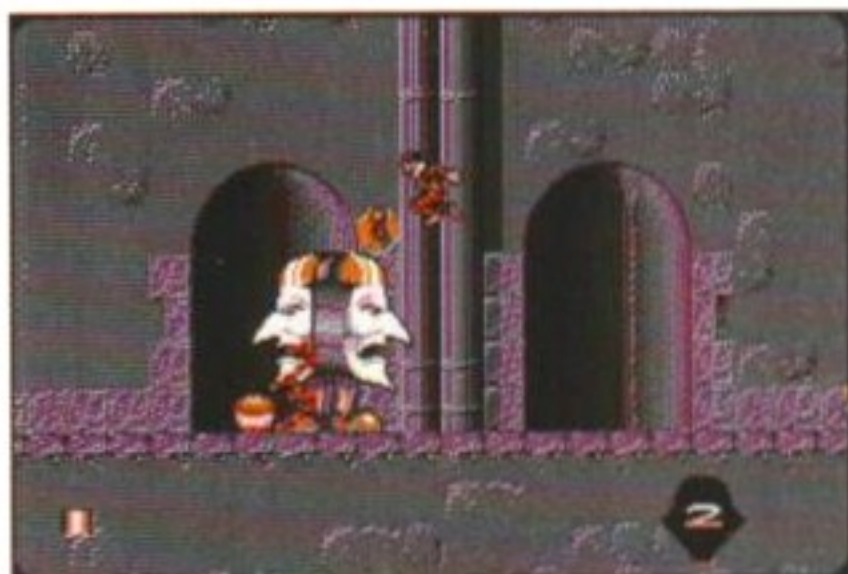
Harlequin

Here you get 23 levels of crazy platform mayhem in search of a vital organ. It got a massive 78 per cent in **Amiga Format 33**.

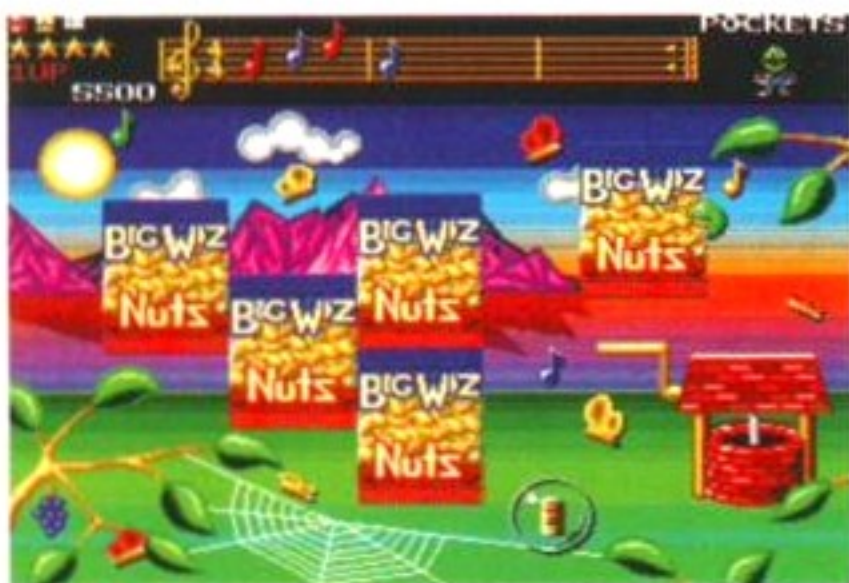
Wizkid

A stunningly bizarre platform puzzle adventure game from the inappropriately named Sensible Software. Scored 93 per cent in **Amiga Format 37**.

Date	Description	Debit	Credit	Code	Balance
01/01/90	Balance				5000.00
02/01/90	Savings		200.00	S	5200.00
04/01/90	Household shopping	55.25		C	4644.75
06/01/90	Club Membership	25.00		M	4394.75
09/01/90	Cash	75.00		H	4669.75
09/01/90	Shopping	55.43		C	4589.32
10/01/90	Mortgage	437.50		H	4151.82
11/01/90	Petrol	16.34		T	4135.48
12/01/90	Clothes	60.98		H	4074.50
16/01/90	Shopping	43.86		C	4030.64
19/01/90	Credit Card	225.63		X	3795.01
19/01/90	Petrol	14.56		T	3780.45
22/01/90	Insurance	24.22		H	3756.23
25/01/90	Car Tax	180.00		T	3576.23
25/01/90	Shopping	43.99		C	3532.24

Personal Finance Manager

Microdeal's DIY domestic-budgeting system is ideal for balancing your cheque-book, or keeping small business accounts!

Two Free Issues

Alternatively, you can have the best free gift of them all – two extra issues of **Amiga Format**. Extra information and entertainment.

Amiga Format subscription & back issues order form

Yes! please enter/renew my subscription to **Amiga Format** and send me the software of my choice

Tick as appropriate

- Harlequin**
Wizkid
Pers. Fin. Manager
Free Issues

UK £38.95
Europe £67.95
Rest of World £97.45

**Please send me the following
Amiga Format back issues**

Give yourself a special treat

ISSUE 1

The Complete Software Guide
More than 150 pages packed to the gunnels with informed comment on all the best software (and some of the duds just so you can compare) available for your Amiga. If you want to track down that rendering program, find out which is the best desktop publishing package or source all the **Amiga Format** Gold-rated games, just flick through the pages of this Special. Over 1,000 items of software reviewed or rated.

ISSUE 2

The Amiga Format Annual 1993
Find out what goes on behind the scenes at **Amiga Format**, the world's best-selling Amiga magazine... and there's more. You can get to read the opinions of some of the UK's foremost Amiga experts as to the future of your machine; we take a look at the year that was 1992, from a distinctly Amiga-esque viewpoint. We tell you about the best software and hardware of the year, and much more. If you've got an Amiga, get this.

ISSUE 3

The Complete Beginner's Guide
A complete look at the Amiga especially tailored to help those new to the machine. Not that there isn't loads here for more experienced owners. From the history of the machine, through all the main areas of its use, we leave no stone unturned in our quest for edifying and didactic data. If you thought you had the world's best games computer, you were right. But read the **Complete Beginner's Guide** to see what else you could be doing.

Name _____

Address _____

Post code _____

Telephone No. _____

Method of payment

Access Visa

Cheque Postal Order

Total Order _____

Credit card No. _____

Expiry Date _____

SEND THIS FORM TO:
Amiga Format Subscriptions
FREEPOST
Future Publishing Ltd
Somerton, Somerset,
TA11 7BR



Please make cheques payable to **Future Publishing Ltd**
This offer is valid until 31 March 1993

AF MAG 3/93

main Distributors

not the imitators!



MEMBERS OF THE PROFESSIONAL STANDARDS OF DISTRIBUTION

New .. The Central Licenseware Register .. New

Commercial Quality programs at a PD price!



CLE01 TOTAL CONCEPTS DINOSAURS Have your children ever wanted to know about the ancient world of the dinosaur? If so, then this is for you - an interactive encyclopedia covering jurassic, triassic & cretaceous periods complete with pictures and information. This program is plus compatible and comes on 2 Disks. £4.50 +



CLE02 TOTAL CONCEPTS GEOLOGY This title is the second in the series of quality programs by Chris Hill, using the GoldDisk Hyperbook system, it will guide you and your children on an interactive guided tour through the incredible world of volcanos, rocks and minerals. The program is very simple to use! Geology is on 2 Disks £4.50 +



CLE03 TOTAL CONCEPTS SOLAR SYSTEM Now our most popular title! This one invites you to learn all about the solar system, with information on all of the planets & systems with pictures supplied by Nasa, this is a superb educational package for children & adults. This title is so big it is supplied on Three disks and is priced at only £4.99. +



CLE04 KIDDIES COLOURING PAD This is a colouring book for young children and they wont get in a mess using it! It is very simple to use with full instructions with the program. Simply pick a picture and colour it in! Includes a save option, so once you have coloured your picture you can save it out to a disk to print out using Dpaint etc. Price £3.50 +



CLE05 A-CHORD So you want become the next Eric Clapton then this is just what you need! This program will teach you nearly every single guitar chord including fingering techniques, it will even play the chords using the amigas built in sound chip. A must for every single guitar player beginner and experts alike. Price £3.50 +

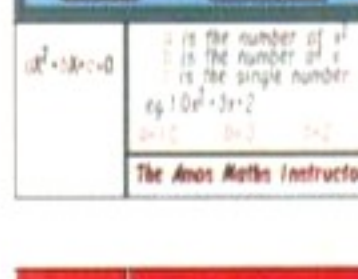

CLE06 THE AMOS MATHS INSTRUCTOR, A superb maths tutorial covering all sorts of mathematical subjects including trig, Quadratic, Simultaneous, Inequalities, Volumes, Area, Vat & Interest and more, an excellent aid for GCSE students. Price £3.50 +



CLE07 TOTAL CONCEPTS FRESHWATER FISHING The latest in the series from Chris Hill, and the first in the hobbyist series, this super title describes baiting Perch, Roach, Rudd, Carp, Bream & many other common freshwater fish. Ideal for the beginner or the hobbyist with many useful diagrams included! A superb title, on 1 disk Price 3.50+



CLE08 NIGHT SKY A superb introduction to the constellations, this program features over 1500 stars, and the sun moon stars & planets can be displayed as seen from any part of the Earth! Large scrolling screen, mouse or keyboard controlled, click on any displayed object for information. This superb title Comes on 1 disk & is priced at 3.50!

CLE09 WORDS & LADDERS An excellent spelling program for 1 or 2 players, each player has a few seconds to spell a word correctly, the player who reaches the top of the ladder is the winner. The program has 10,000 words so some words can be quite long, however you can select the level! Will also provide printed output to a connected printer, 3.50!

CLASSIC CLIPART

(Okay on A1200 / A4000.)

The clipart in this collection is very high quality, huge bitmaps, many greater than an Amiga hires screen, for use in Dpaint or DTP packages, each disk autoboots as a slideshow allowing you to view the entire bitmap by moving the mouse! (Prices per disk!)

- ART01 WEDDINGS Superb wedding clipart. 2 disks!+
- ART02 HOUSES 2 disks, pictures of mansions etc!+
- ART03 RELIGIOUS 3 disks full of holy clipart!+
- ART04 WWI AIRCRAFT 1 disk of World War II planes!+
- ART05 MEN 2 disks full of men at work!+
- ART06 WOMEN 2 disks full of women clips!+
- ART07 KIDS 2 disks containing kids clipart!+
- ART08 BUSINESS Disk full of office clipart!+
- ART09 OFFICE Another office type disk!+
- ART10 STUDENTS Lots of student type pics!+
- ART11 SALETIME Many useful logos etc!+
- ART12 XMAS 3 disks of Xmas related pics!+
- ART13 PUNCH 3 disks of cartoon pics!+
- ART14 ANIMALS Fantastic quality pictures!+
- ART15 CATS Only 12 pics but super quality!+
- ART16 SILHOUETTES 18 super silhouettes!+
- ART17 SCHOOLS 2 disks of school pictures!+
- ART18 BABIES Clipart on a baby theme!+
- ART19 SPORT 2 disks full of sport pictures!+
- ART20 OLYMPIC Another sport type disk!+
- ART21 MEDICAL 2 disks full of medical clipart!+
- ART22 SEALIFE Pictures from the Ocean!+
- ART23 DECORATIVE MONTHS Pic for every month!+
- ART24 WACKY Funny comic type clipart!+
- ART25 HOLIDAYS Holiday type pictures!+
- ART26 BANNERS 2 disks full of banners!+

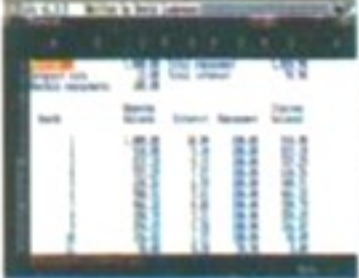
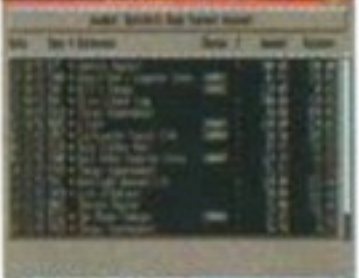
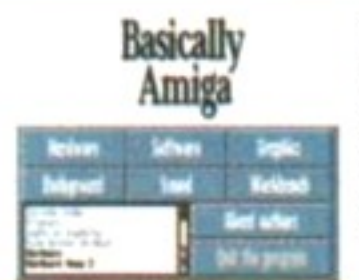

Basically Amiga

CLE10 BASICALLY AMIGA This is a 3 disk set for the new user! An extensive guide through the use of Amigados. Covering Hardware, Software, Graphics, Sound, the Workbench, Viruses and much much more, you will soon wonder how you did without this useful utility pack! For young and old users alike. 3 disk set priced at 4.99! +

SMOOTH SCROLLING TITLES

created with VIDEO TITLES

CLE11 LET'S LEARN V1.1 For children of about 5 to 7 years of age, each part progresses through five levels of difficulty, when a level is satisfactorily completed then a picture of a farmyard is displayed & a new animal introduced! Try Sums, Tunes, Codes, (numbers), Opposites & Squares! The program also has a print option! 1 disk 3.50. +

CLU01 VIDEO TITLER is a program that will allow you to create smooth scrolling video titles with the greatest of ease, programmed by Darren Mccaui, whose Starbase is due out soon, the program lets you use any amiga bitmap font, of which several are supplied, and scroll in any colour vertically up the screen. Essential for all video enthusiasts. £3.50 +

CLU02 FISH INDEXER If you have ever wanted a program, but have never been able to find it ANYWHERE chances are it's probably in the fish library, but rather than having to rake through thousands of lines of text, why not use the Fish Indexer, a superb database of the entire Fred Fish library, with full search, print and more. Price £3.50+

CLU03 TYPING TUTOR A program here now for all you budding office clerks, learning to type can be a real pain, lessons cost a fortune, but when you have an amiga! This program will take you step by step through a full typing course, showing where to place your fingers and lots more. Before long you'll be able to type as fast as I can! Price £3.50 +

CLU04 ALPHA GRAPH This is an extremely useful program for the production of pie charts, bar charts, Block scatter etc, very useful in conjunction with spreadsheets & other business programs, this program comes on one disk and is priced at 3.50!+

CLU06 SUPER SOUND III This is a superb program which can manipulate samples in almost any way you please, special effects such as reverb, tremolo, phasing, phlanging, echo are just a few of the things which are easily accomplished, the equal of expensive commercial software! Price 3.50!+

CLU10 POWER ACCOUNTS This is an accounting package for keeping check on your bank account, and is capable of generating account statements and income & expenditure reports. The program will also allow you to "password protect" your data files! An invaluable program for all of your finances, comes on 1 disk, price 3.50. +

CLU11 CALC V1.3 A nice spreadsheet program which works on any Amiga! A spreadsheet is an electronic version of the traditional method of performing complex calculations using rows & columns of figures. In the same way a wordprocessor allows rearranging & editing before printing, so a spreadsheet allows figures & calculations to be constantly changed! 3.50. +

- ART27 ART NOUVEAU FLOWERS Floral art!+
- ART28 BUTTERFLIES Nice pictures!+
- ART29 FOOD 2 disks on a food/kitchen theme!+
- ART30 COLOURING BOOK Colour in Dpaint!+
- ART31 BORDERS 2 disks, must load into DTP!+
- ART32 MAC CLIP 2 disks high quality macart!+
- ART33 HORNBACK Nice scenic clipart!+
- ART34 TEDDY BEARS 2 disks of Teddy bears!+
- ART35 VANITY FARE 2 disks fashion clipart!+
- ART36 HALLOWEEN CLIPART Wierd clipart!+
- ART37 SHOWTIME Dancing, singing etc!+
- ART38 VEGGIES Vegetarian clipart!+
- ART39 FLORAL 14 very detailed pictures!+
- ART40 MYTHS Mythical images + zodiac!+
- ART41 DOG WOODCUTS Super 300dpi pics!+
- ART42 CAT WOODCUTS Great wildcat pics!+
- ART43 AFRICAN WOODCUTS African animals!+
- ART44 AMERICAN WOODCUTS More animals!+
- ART45 ARTIC WOODCUTS Northern animals!+
- ART46 FARM WOODCUTS Farm animals!+
- ART47 MIXED ANIMAL WOODCUTS Nice pics!+
- ART48 BIRDS WOODCUTS 18th century bird pics!+
- ART49 MORE ANIMALS More superb pictures!+
- ART50 ANIMAL LINEART Varied selection of pics!+
- ART51 BOTANICAL ART Very detailed plant pics!+
- ART52 FAMILY SCENES 2 disks of domestic life!+
- ART53 GOLF HUMOUR 2 amusing cartoon disks!+
- ART54 SPACE & TRANSPORT On a space theme!+
- ART55 SOFTSCENE2 29 rural scenery pictures!+
- ART56 SPORTS3 More pics on a sports theme!+
- ART57 NAVY Lots of naval type pictures!+
- ART58 TRAVEL 2 disks on a travel theme!+
- ART59 ALPHABET Borders & alphabet clips!+
- ART60 ACCENTS & FLASHES Burst stars & more!+



CLU12 VIRTUAL WINDOWS V1.0 Collectively a suite of very useful programs, all on one disk! Features Notepad, Address book, Desk diary, Software VHS inventory & an Amigados survival guide. All can be accessed from a menu system with the mouse & are very easy to use. Price 3.50. +

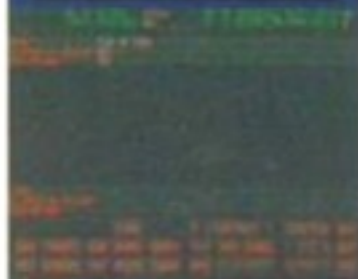

CLU13 DATOS A powerful easy to use database with many features: audible tone, keyboard/mouse control, template feature, cut & paste with mouse, help features, rearrange/add fields even after creation, warning messages, can print down or across the page to save paper, many more features too numerous to list. Price 3.50 +



CLG05 TRUCKIN ON This is a new version of a PD game that was originally bugged to hell, the programmer has taken all the main elements of the game and re-programmed it in C, so its now fully playable truck driving simulation and management program. TO is a must for all you truckers out there and is supplied on 2 disks & needs 2 drives! 4.50.



CLG08 DRAGON TILES This is an excellent puzzle game you have a huge stack of different icons which, using the mouse you must match up to make a level disappear, sounds boring but its actually very addictive, I was playing it for hours! A vast improvement on the PD version, Dragon tiles is well worth anyones couple of quid! Price £3.50 +



CLG09 MOTOR DUEL Now this is just fabulous! Martin would not leave this game alone for days, its a 3D car racing-chasing-shooting game, with guided missiles and lasers, its by the same programmer as the PD game Battlears, but its a lot better, play the computer (Mega difficult) or link up to another amiga for 1 on 1 action! Price £3.50 +



CLG011 ALL GUNS BLAZING This is a two player car racing game viewed from overhead. You can also blast the other player's car with missiles, lay mines, oil slicks and smoke. There is also a facility to design your own tracks to your own satisfaction. Price 3.50! +

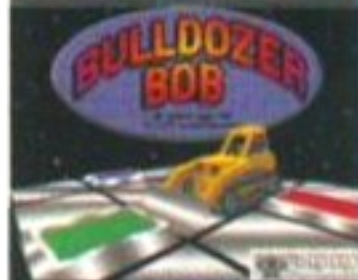

CLG012 BULLDOZER BOB The object of the game is to clear the screen of coloured blocks by pushing them together. Once they touch they disappear! You have a limited number of moves to clear the screen, and the difficulty increases with each level. This is definitely a game for puzzle fans! Price 3.50! +



CLG013 PARADOX Yes- another good puzzle game, similar to Bulldozer Bob, but Mr Cool head is doing all the pushing! Push the coloured balls till they touch & disappear! There is a time limit for each screen & a variety of objects to collect but beware of traps! Very addictive game. 100 levels of gameplay! Price 3.50! +



CLG015 SPLODGE THE ESCAPE Great platform game. Splodge was going on holiday to Ganymede when the spacebus on which he was travelling was hi-jacked by Big hairy monsters! He was imprisoned in an old house behind a Rongart spaceport building! You must guide Splodge, solving puzzles & collecting coins to buy a ticket home to Jupiter. Price 3.50 +

MORE CLR TITLES ALSO AVAILABLE:

- CLU08 WORD FINDER crossword & anagram solver & dictionary! 2 disks 4.50 +
- CLU09 PLAY & RAVE2 Music module linker. create your own tunes! 2 disks 4.50 +
- CLG01 NORRIS A medieval romp across many levels! very addictive! 1 disk 3.50 +
- CLG02 DARK THINGS Another scrolly run & jump platform game! 1 disk 3.50 +
- CLG03 PHASE II This is a sideways scrolling shoot em up. 1 disk 3.50 +
- CLG04 X-SYSTEM Multilevel shoot up, blast end of level monsters! 1 disk 3.50 +
- CLG14 SONIC SMARTIEHEAD Platform game for 8 years & over! 1 disk 3.50 +
- CLG17 IMBRIUM DAY OF RECKONING Excellent graphic adventure! 1 disk 3.50 +

NEW FROM WEIRDSCIENCE!!
5 superb slideshows for the new Amiga 1200 & 4000 systems in Hires AGA 256 colours! Now you have something to showoff your new machine! Not many pictures per disk as they are in Hires with music backing! Fabulous!!

WS AGA1
WS AGA2
WS AGA3
WS AGA4
WS AGA5
ABSOLUTELY NOT AMIGA 500/600!

FUNPACK GAMES
A HUGE COLLECTION OF PD GAMES ON 30 DISKS, ALL A500+600 COMPATIBLE - A MUST FOR THE KIDS. (MOST OK ON A1200!)
All 30 for Only £29.95!

ASSASSINS GAMES
THE ULTIMATE COLLECTION OF GAMES FOR THE AMIGA, ALL THE GAMES IN THIS PACK ARE THE BEST AVAILABLE, NEARLY EVERY GAME YOU CAN THINK OF INCLUDING: PACMAN, INVADERS, GALAXIANS, ASTEROIDS, CARD GAMES, TETRIS, PUZZLE GAMES, WELL OVER 130 GAMES IN TOTAL - PACKED ONTO AN AMAZING 35 DISKS! (Smaller packs on request)
All 35 for Only £34.95!
PHONE FOR A500+600 COMPATIBILITY

PROGRAMMERS: Have you written a good program, ie a utility, educational program or a game? Why not send it in for evaluation? If its really good, then you too could be earning money!!!

BLITTERCHIPS

UF12 CLIFFE HOUSE, PRIMROSE STREET, KEIGHLEY, BD21 4NB.
TEL: 0535 667 469
FAX: 0535 667 469

NBS

UF12 ICHAIN LANE NEWPORT ISLE OF WIGHT PO30 5QA
TEL: 0983 529 594
FAX: 0983 821 599

VALLY PD

UF12 PO BOX 15, PETERLEE CO. DURHAM SR8 1NZ
TEL: 091 587 1195
FAX: 091 587 1195

We pick out top-quality software and indispensable hardware for you and your Amiga, and we deliver them to you at bargain prices.

**CREDIT CARD
HOTLINE
0458 74011**

Make sure you check out our amazing back issues and subscription offer on Page 169!

10 Great Games Comp

MAIL ORDER

SAVE £6

Xenon 2, Pro Tennis Tour, Ferrari Formula One, Nighthunter, Rick Dangerous, Super Ski, Pick 'n' Pile, Carrier Command, Chicago and Satan all in one massive pack! (Doesn't work on A500 Plus or A600).

Description	Price	Order Code
10 Great Games	£24.99	AFGGComp

Two Great Games

MAIL ORDER

SAVE £6

A fantastic package with Imageworks' *First Samurai* arcade adventure doubling up with another *Format Gold*-winning game: *Mega-lo-Mania*, the godlike strategy game from Sensible Software.

Description	Price	Order Code
Two for one	£24.99	AFMegSam

Fun School 4

SAVE £7

Let the kids and the Amiga make friends, with Europress' acclaimed education software!

Description	Price	Order Code
Teddy Disk	£17.99	AM231
Frog Disk	£17.99	AM232
Spy Disk	£17.99	AM233

Home Accounts 2

SAVE £10

Described by *Amiga Format* as 'a package which will suit any household', this is the ideal way to keep track of your financial affairs, from what's in your cheque account to how much is left after the bills!

Description	Price	Order Code
Home Accounts 2	£44.99	AF229

mini Office

MAIL ORDER

SAVE £10

Everything you need to turn your own home into an integrated business environment all in one handy package. A word processor, spreadsheet, database, graph utility and disk organiser in a complete set.

Description	Price	Order Code
mini Office	£49.99	AFMinOff

Amiga Format Mail Order

RAM Expansion

SAVE £4

It's well over a year since new Amigas were sold with less than 1Mb of memory. Nowadays many games as well as most serious software, require that magic meg. Here's a bargain way to upgrade your A500.

Description	Price	Order Code
512K RAM Expansion	£25.99	AM237

Amiga Format Binder

MAIL ORDER

Are you tired of all your *Amiga Formats* being left scattered all over the floor? If so, protect them with these stylish and practical black-and-silver binders.

Description	Price	Order Code
One binder	£4.95	AF108
Two binders	£9.00	AF109

New Technosound Turbo

MAIL ORDER

SAVE £10

Newly updated sampler from New Dimensions enables you to grab digitised sounds, then sequence them into simple compositions. It contains a new cartridge, updated manual and a set of audio leads.

Description	Price	Order Code
Technosound Turbo	£29.95	AF246



The **AMIGA** Collection

FORMAT

Easy AMOS

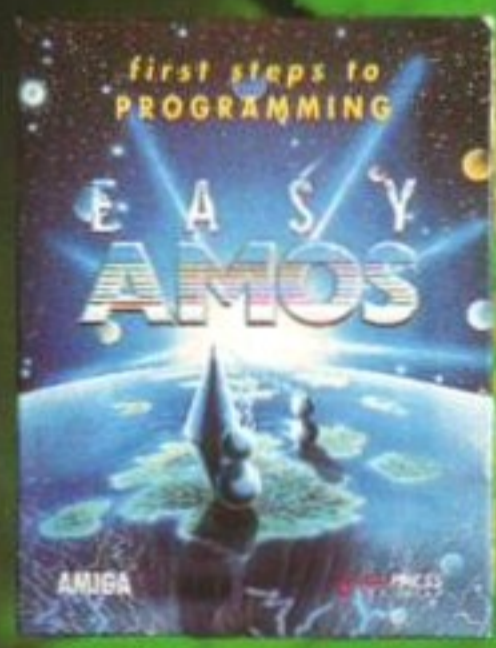

first steps to PROGRAMMING
EASY AMOS

MAIL ORDER

SAVE **£14**

Designed for the beginner who wants to learn programming but doesn't know where to start, *Easy AMOS* is more than a programming language. Based on the successful *AMOS*, it has many helpful examples and detailed explanations to help you learn.

Description	Price	Order Code
Easy AMOS	£29.99	AF250

AMOS Compiler & AMOS 3D



AMOS THE CREATOR

Create games!
Create demos!
Create to educate!
Create ANYTHING!

MAIL ORDER

SAVE **£15**

If you want to get the most out of *AMOS*, why not buy the two most popular *AMOS* extensions in one pack? The *Compiler* translates your *AMOS* creations into stand-alone 100 per cent machine code, while *AMOS 3D* lets you create amazing 3D worlds!

Description	Price	Order Code
AMOS Bundle	£49.95	AF247

AMOS Professional

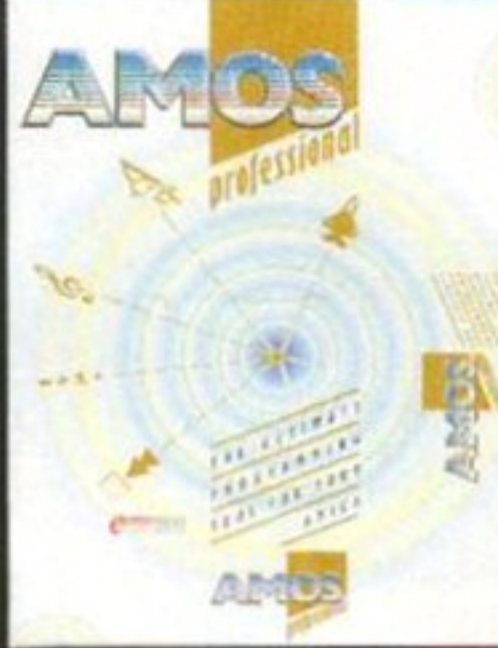

AMOS professional

MAIL ORDER

SAVE **£10**

This is the highest-rated package ever reviewed in *Amiga Format*. Top of the *AMOS* range it updates the famous *AMOS* extended basic programming language with new commands and facilities that make it a real winner! (Needs 1Mb minimum)

Description	Price	Order Code
AMOS Professional	£59.99	AFAMPRO

AMIGA FORMAT

174

AMOS Manual

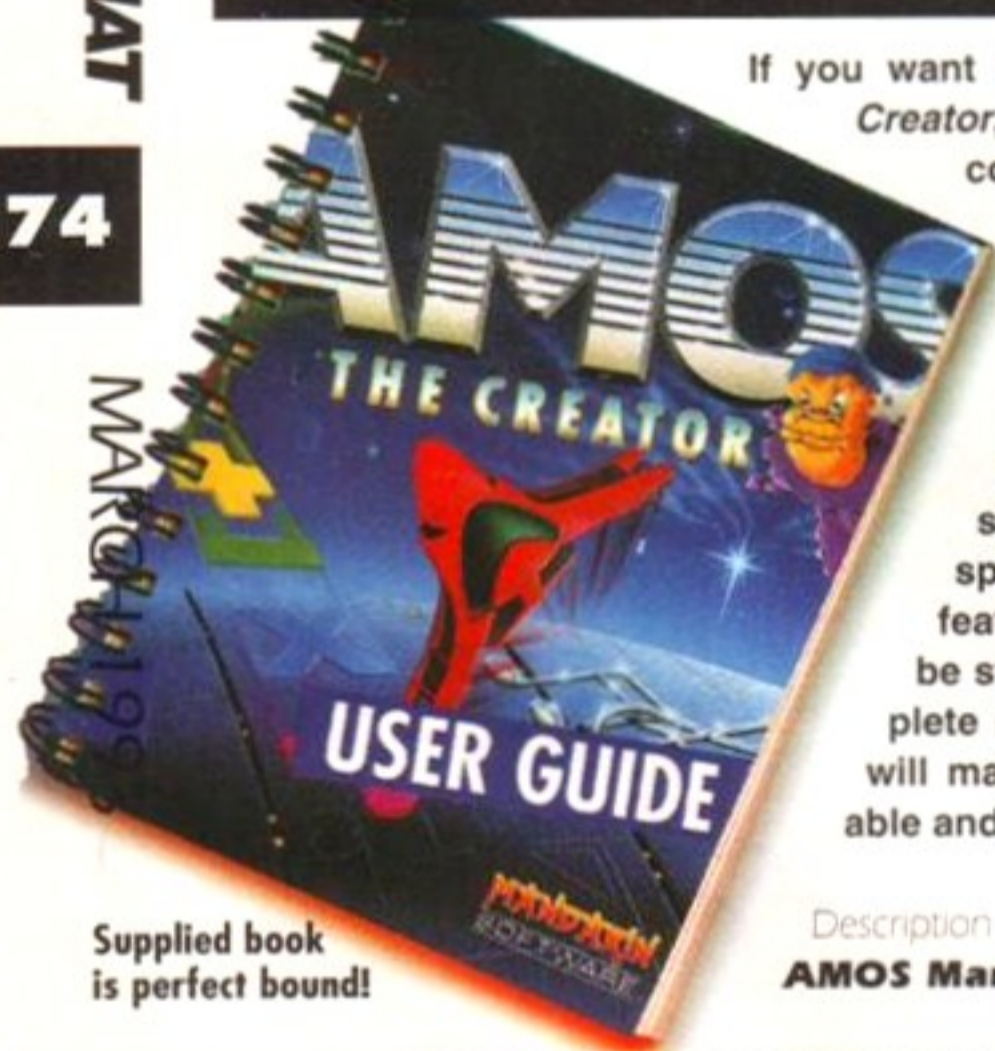

If you want to make the most out of *AMOS The Creator*, this is exactly what you need. It's the complete manual, as supplied with the package, and it also includes an Extras disk that contains all the example programs and extra bits and bobs that we couldn't fit on the Coverdisks this month. We'll continue to give lots of tutorials and advice, and showing you techniques for creating specific kinds of programs, as a regular feature in *Amiga Format*, so you wouldn't be stuck without this book: but as the complete reference work, you'll find The Manual will make your *AMOS* career far more enjoyable and creative!

Description	Price	Order Code
AMOS Manual	£13.95	AF249

Supplied book is perfect bound!

Graphics Workshop Manual

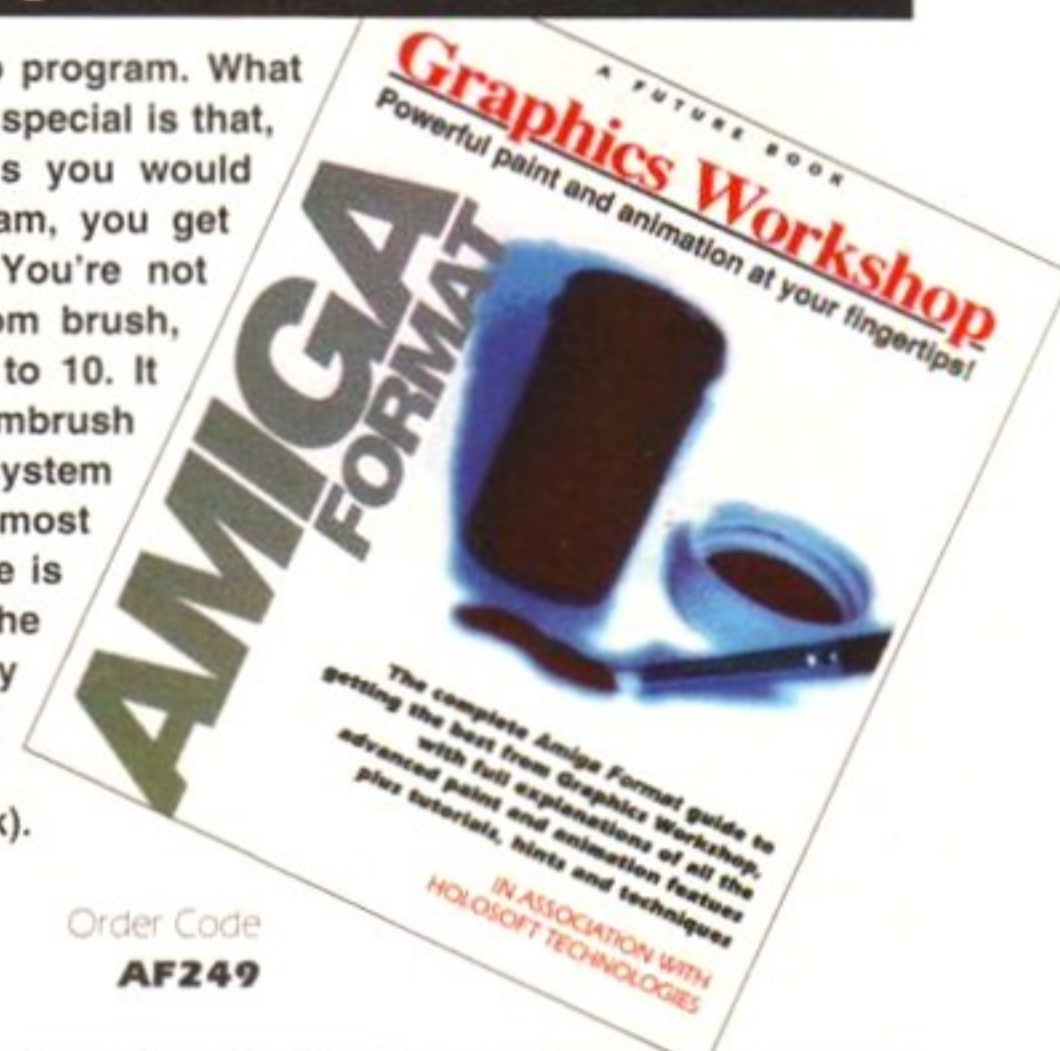

Graphics Workshop is a superb program. What makes this drawing package so special is that, along with all the normal tools you would expect from a top paint program, you get some powerful extra utilities. You're not just limited to using one custom brush, you can pick up and store up to 10. It also features ANIM and Animbrush forms of animation, and a cell system which is quite probably the most powerful animation system there is for the Amiga. Why not get the most out of this top program by buying this expertly illustrated instruction book and tutorial guide (with a special tutorial disk).

Description	Price	Order Code
AMOS Manual	£13.95	AF249

Amiga Format Mail Order

Name

Address

Post Code

Phone Number

Description

Price

Order Code

Total order

Method of payment (please circle) Access Cheque Visa PO

Please make cheques payable to:

Future Publishing Limited

All prices include posting, packing and VAT

Credit Card number

Expiry Date

SEND THIS FORM TO:
Amiga Format,
Future Publishing Limited,
Somerton, Somerset TA11 6TB

PLEASE DO NOT SEND CASH,
USE METHOD OF PAYMENTS LISTED ABOVE

For overseas orders call Nikki
 for prices on + 44 458 74011
 AFM/3

WE ARE OPEN ALL HOURS

9am-10pm Mon-Sat
10am-6pm Sun

HARDWARE

A600 + Joystick + Mouse Mat	£294.00
A600	£289.00
A1500 & Software	£565.00
1084S Monitor	£199.00
GVP series 2, Hard drive 52 Meg	£350.00
1 Meg sims	£24.00

Phone for 2000 & 3000 prices.

ACCESSORIES

Amiga Int drive	£49.00
Cumana Ext drive	£54.00
Zydec Ext drive	£51.00
512K upgrade with clock	£23.50
512K upgrade no clock	£17.00
1.5 Meg upgrade with clock	£79.00
1 Meg Amiga plus upgrade	£37.00
8 Meg fast ram, 4 Meg populated	£169.00

PRINTERS

Star LC-20	£133.00
Star LC 24-10	£199.00
STAR LC100 Colour "NEW"	£169.00
Star LC200 Colour	£194.00
Star LC-24-200 Colour	£274.00

JOYSTICKS

Quickshot II	£6.50
Python Micro Switched	£8.00
Speedking Autofire	£10.50
Competition Pro Extra	£12.50
Mini Competition Pro	£13.50
Maverick Autofire	£12.95
Zipstick Autofire	£12.95
Intruder	£21.50
Aviator Flight Sim	£23.50
Jet Fighter	£12.99

DISKS with labels

Unbranded Bulk 100% Certified

3.5" DSDD	37p each
3.5" Rainbow	44p each
3.5" DSHD	55p each
5.25" DSDD	28p each

Branded Disks

3.5" DSDD	50p each
3.5" Labels per roll of 1,000	£6.50
3.5" Tractor feed per 1,000	£8.50

Please phone for bulk purchase discounts

STORAGE BOXES

10 capacity	£0.95
NEW 200 Cap box stackable/lockable	£16.50
50 capacity lockable	£3.95
100 capacity lockable	£4.50
80 cap Banx stackable/lockable	£8.99
150 cap Posso stackable/lockable	£15.00
250 cap stackable/lockable	£18.99

Most of the above available in 3.5" and 5.25"

LOOK! LOOK! LOOK!

TRACTOR FEED DISK LABELS

500 plain white labels & software to print your own professional labels

Only £9.95

SPECIAL OFFER

1000 labels with software £13.50

MISCELLANEOUS

Mousehouse	£1.60
Mouse Mat	£2.50
Disk Drive Cleaner	£1.80
Amiga Dust Cover	£3.50
Monitor Dust Cover	£3.50
Mouse/Joystick Auto Shift	£12.50
Amiga Light Pen & Software	£32.00
Optical Mouse	£32.00
Squik Mouse	£12.99
Naksha Mouse & Accessories	£22.00
Zy-Fi Amplifier & Speakers	£37.95
Thumb & Finger Trackerball	£19.99
Crystal Trackerball	£32.00
Action Replay Mark III	£57.00
Techno Sound Turbo Sampler	£32.00
2 Piece Printer Stand with tray	£5.70
Midi Master	£26.00
Wordworth 1.1	£77.50
Tilt/Turn Monitor Stand	£8.50

Orders by phone or post to:
DIRECT COMPUTER SUPPLIES

0782 - 311471 Anytime
0782 - 642497 9am - 5.30pm week
0630 - 653193 Evening/Weekend

54 Spring Road,
Longton,
Stoke-on-Trent,
Staffs ST3 2PX

Prices include VAT
Postage please add £3.30
We accept cheques/
P.O.'s/Visa/Access

AMIGA REPAIRS

Repairs undertaken to Amiga 500 computers at £44.95 inclusive of parts, labour, VAT and return postage/packing

Commodore registered for full technical support

Computers repaired in the quickest possible time

All machines will be overhauled with a full soak-test to ensure optimum reliability

Entrust your machine to the experts, full 90 day warranty

Repairs to disk drive and keyboard also included
(extra charge possible if found to need complete replacement)

Repairs to other Commodore systems undertaken - phone for details

Upgrades and expansions supplied and fitted - phone for details

£44.95

To take advantage of this exceptional offer, simply send or hand deliver your computer to our workshop complex, address details below, enclosing this advertisement voucher, payment, fault description, return address, along with your daytime and evening telephone number and we will do the rest. Should you require Group 4 Security return delivery, simply add £5.00 to the repair charge.



WTS Electronics Ltd Chaul End Lane Luton Bedfordshire LU4 8EZ Tel 0582 491949 (6 lines)

(We reserve the right to reject machines which, in our opinion, are beyond repair - Normal charge applies)

17-BIT DISK PRICES
17-BIT DISKS £1.25 EACH
FISH DISKS £1.25 EACH
SCHEME 17 DISKS £2.00
CLR DISKS £3.50 SINGLE
CLR 2 DISK SET £4.50
CLR 3 DISK SET £4.99

GET 1 DISK FREE WITH EVERY 10 YOU BUY!
ORDER 20+ AND GET 3 DISKS FREE!

ORDERING COULDN'T BE EASIER!
 WE TAKE ALL MAJOR CREDIT CARDS INCLUDING SWITCH SO PHONE US NOW ON:-
TEL: (0924) 366982 (2 LINES)
OR FAX: (0924) 200943
FOR SAME DAY DESPATCH!
 PLEASE MAKE CHEQUES AND P.O.'S PAYABLE TO:
17 BIT SOFTWARE
 1ST FLOOR OFFICES, 2/8 MARKET STREET
 WAKEFIELD, WEST YORKSHIRE, WF1 1DH

OFFICE HOURS ARE MON-THURS 9AM TO 8PM
 FRI & SAT 9AM TO 5.30PM
 WE ARE OPEN TO CALLERS MON-SAT UNTIL 5.30PM

AMIGA PUBLIC DOMAIN
FROM 17-BIT SOFTWARE
 The UK's Leading PD library, over 4000 disks in stock, over 40,000 satisfied customers worldwide
 WE STOCK FISH, T-BAG, CLR, AMOS. **AND MUCH MORE!**
 STOP PRESS WE NOW STOCK FISH TO 780 !!



SOFTWARE BARGAINS!

4D Sports Boxing	£7.99
Alien Breed Remix	£9.99
A320 Airbus	£26.99
Assassin	£18.99
Altered Destiny	£9.99
Action II Compilation	£8.99
Brides Of Dracula	£9.99
Cadaver	£8.99
Caesar	£18.99
Continental Circus	£5.99
Chuck Rock	£11.99
Curse Of Enchantia	£19.99
Chrono Quest	£8.99
Chrono Quest 2	£8.99
Chronicles Of Omega	£8.99
Deathbringer	£9.99
Dune	£19.99
Delta Force Comp.	£8.99
Die Hard 2	£8.99
Double Dragon	£4.99
Enchanter	£7.99
F16 Combat Pilot	£11.99
Fuzzball	£9.99
Flight Of the Intruder	£14.99
Fire Force	£18.99
Gates Of Jambala	£7.99
Harlequin	£14.99
Keys To Maramon	£7.99
Lotus III	£17.99
Lure Of The Temptress	£19.99
Midwinter II	£12.99
Megalomania	£11.99
Moonshine Racers	£7.99
Magnetic Scrolls Coll.	£10.99
Mercenary III	£9.99
Movie Stars Comp.	£8.99
Myth	£14.99
Ninja Warriors	£4.99
Omicron Conspiracy	£8.99
Pictionary	£6.99
Photon Paint 2	£12.99
Project X	£17.99
Putty	£18.99
Renaissance Comp.	£6.99
Realms	£11.99
Shadow Of The Beast II	£11.99
Silkworm	£6.99
Sorceror	£7.99
Special Forces	£14.99
SWIV	£7.99
Superheroes Comp.	£12.99
Under Pressure	£6.99
Vengeance Of Excalibur	£12.99
Warlock	£7.99
Wolfchild	£12.99
Zool	£17.99

SPACE WARS
 The dynamic 24 bit raytraced video has arrived. The legendary Tobias Richter presents his most stunning piece of work to date. Supplied on high grade VHS videotape, this 8 minute movie took 5 Amiga A3000's working round the clock - a staggering 6 weeks to render! Truly a masterpiece, but don't just take our word for it...

"...It's hard to believe that this is just an animated movie... If you're after state-of-the-art ray-traced animation or just want to see what the Amiga is capable of you just have to buy this video"
 CU AMIGA Jan 93.

"Wickedly humorous... This video contains far and away the most impressive animation I have ever seen, period."
 AMIGA COMPUTING Feb 93

SPACE WARS - THE MOVIE
 £11.99 +75p P&P

CDPD VOLUME #1
The complete collection of Fish disks (to 660) on one packed CD!
 Only £19.99 + 75p P&P!

CDPD VOLUME #2
The continuation of the Fish library including the full SCOPE range too!
 £19.99 + 75p P&P!

DEMO CD VOLUME #1
Thousands of demos, intros, modules, games, anims and clipart all on one mega CD.
 Only £19.99 Please include 75p P&P

LATEST PD

+2354	..ANIMATION CONSTRUCTION KIT
+2353DELUXE PAC MAN
+2352SKYBOARDS MUSIC
2351METROPOLIS DEMO
+2349HYPERDRIVE
+2348HYPERDRIVE (1.5M)
+2347SHOOT-EM-UP
+2346(AB)CULT TV VOL 2
+2345NS#1
+2344SANITY W.O.C.DEMO
2343VANISH W.O.C.DEMO
+2341(AB)XBENCH
+2340BOAT ANIM
+2339(AB)THE JOURNEY (mega)
+2338(AB)QL EMULATOR
+2337ACID PUNK SLIDES
+2336(AB)	...LAWNMOWER MAN SLIDES
+2335BOOTX 5.20
2334GRAND PRIX MANAGER
+2333(AB)	..THUNDERBIRDS ARE GONE!
+2332ESCAPADE
+2331(ABC)GRAPEVINE 13
+2330SLIDE CONS KIT
+2329CED V1.51
+2328ELEVATION GAME
+2327(ABC)THE AD
+2326INTREPID
+2325(AB)IRON CLADS
+2324TEXTURES
+2323PCQ SHELL
+2322SOUND ENHANCER PROJECT
+2321FIGHTING WARRIORS
+2320FREEDOM CRACK 10
+2319DATABASES V5.5
+2318GRINDER
+2317OUTERIM
+2316KASTLE KUMOUAT
2315(AB)DEVIOUS
+2314ALVIN AEROSOL
+2313ASGARD CHEATS DISK
+2312PRIZE FIGHT DEMO
+2310ASI HANDY TOOLS 2
+2309ASI HANDY TOOLS 1
+2307ASI GFX UTILS
+2304KAOS THEORY
+2303DREAMS CRUNCHERS
+2302(AB)ROAD HOG ANIM
+2301HOBBITS SUPPLEMENT
+2300MATCHSTICK MEN
+2299UGH! AMIGA DEMO
+2297SHADOW SLIDESHOW
+2296(AB)FRIDAY 13TH (1.5M)
+2295XMAS ANIM
+2294DR WHO THEME VARIATIONS
+2293CAR SLIDESHOW

MACART PACK
 12 Disks packed with images from the likes of Viz, Comic Clipart and loads of other miscellaneous stuff.
 All 12 disks for £13.00 Inc. P&P

GAMES GALORE
 Dozens of games packed onto 12 disks for the kids (and parents!) to enjoy. All 12 disks for the pack price of just £13.00 Inc P&P

CLIPART PACK
 Not Macart, but 14 disks crammed with categorised clipart such as people, places, occasions etc.
 All 14 disks for £15.00 Inc P&P

ASSASSINS PACK
 30 disks exploding with over 130 games! That's enough to keep any games enthusiast busy for a LONG time!
 £29.99 Inc P&P

COLOUR FONTS
 10 disks filled with colour fonts for you to use with your favourite word processor or paint package.
 Just £11.00 Inc P&P

Ps - FONTPACK
 Another 10 disks of very high quality fonts for use with Pagestream 2.0 or Pro-Page V3.0
 Take the lot for £11.00 Inc P&P

ACCESSORIES
 Disk boxes (100) ..£7.99
 Mouse Mats.....£2.99
 A500 Dust Covers ..£2.99
 A600 Dust Covers ..£6.99
 Zipsticks.....£11.99
 Cruiser Joysticks ...£9.99
 Blank Disks (10)...£6.99

Please Note...
 If you are ordering disks by phone, please state whether they are multiple, ie (ABC) after a number means that particular title is on 3 disks. Thanks.

Postage Rates
 Please add 50p to all PD orders for P&P
 Overseas please add 20% (min £1.00). If you are buying commercial titles please add 75p per item.

AMFM 10
 Includes MIDI for beginners, utils, reviews, music + Loads more.
 £2.50 per Issue

CAT DISKS
 Are available at 59p each (we now have 4!) or free if a stamped addressed envelope is sent.

GRAPEVINE 13
 Full of the usual hot news and articles.
 £3.75 (3 disks)

Boulderdash Pack!
 10 superb disks full of the classic Boulderdash/ Emerald Mine games including an editor to create your own caves!
 All 10 disks can be yours for £11.50 Including P&P!

STRATEGY GAME SPECIAL!!
BUY MEGALOMANIA & REALMS TOGETHER
FOR THE AMAZING PRICE OF ONLY £21.99!
THAT'S FAR LESS THAN JUST ONE TITLE WOULD COST AT FULL R.R.P!!! PLEASE INCLUDE 75p P&P

HOBBITS + SPACESHIPS
 From the Crusaders Duo comes a new experience in synthesised music. Bjorn "Dr Awesome" Lynne & Seppo "Flashbrain" Hurme present their first 100% professional audio CD. This is NOT recorded Amiga music! It is produced on the best equipment available and sounds STUNNING when played LOUD!
ONLY £12.99 + 75p P&P

THE LAWNMOWER MAN DEMO
17-BIT, DISKS 2336A&B

Yes! It's that scene from *The Lawnmower Man*. Virtual Sex, or Teledildonics, comes to your Amiga (we wish).

In the PD Demo Zone of Issue 42, we featured two demos by the Wyld Stallions: *Ghost* and *Highlander*. Both demos comprised several digitised screens from the respective films, loaded one by one from disk, with an accompanying soundtrack. Although the images were good quality, the demos lacked substance. It's not worth releasing a disk full of screenshots from a film on to the PD scene.

Despite our criticisms, Wyld Stallions new release, *The Lawnmower Man*, doesn't diverge from the original format. In this case, though, they've chosen a film which is visually stunning, and so the resultant images are very impressive. As you may expect, all the digitised pics are from the computer-generated parts of the feature film, even though this makes up just three minutes of the entire film.

An interesting curio, worth a quick look if you're into computer graphics. If you're a fan of the film, then buy the video.

BOAT ANIM
17-BIT, DISK 2340

Remember the great Christmas anim reviewed last issue? Carl.Inc have been hard at it since then, and have produced another demo in a similar vein entitled *Boat*. The scene is set in a typical suburban backyard, with a shipshape, sailor-type person putting the finish-

PD Demo Zone



Whether you're new to the Amiga or an old hand, what better way to find out what everybody's doing with their machines than a quick scan through the Public Domain demo scene. Join **Andy Nuttall** for this month's guided tour around the Amiga's finest...



Carl.Inc bring you several things this month: a mole, an electric dog, and an interesting pair up top... (the birds).

ing touches to his little boat. All of his family, including the dog, are there to lend a hand, and other characters take cameo roles. These include a mole who digs through the turf, then dives back down to the safety of his hole before waving a tiny, white surrender flag, and a window cleaner who gets an eyeful from a naked couple who are frolicking in their bedroom.

Like the previous anim, the thing that sets this apart from other animations is the fact that it's made up from one five-second loop, which is in continuous rotation. To achieve continuity in such an animation is incredibly difficult. Well done Carl.Inc - keep 'em coming.

Continued overleaf

THUNDERBIRDS ARE GONE!
17-BIT, DISKS 2333 A&B
ANIM

Scott gets the kind of half-baked message usually reserved only for answering machines...

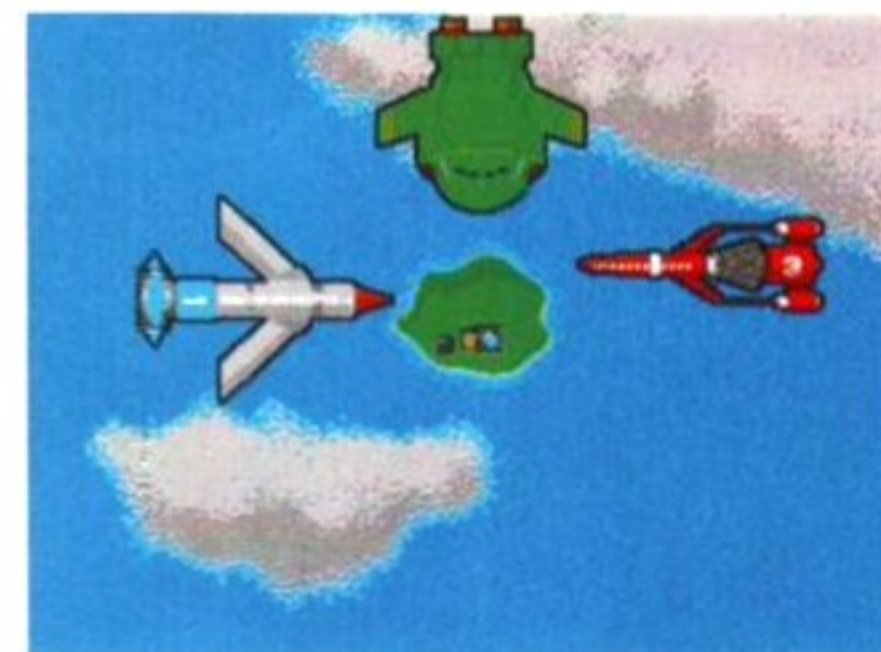

...and yes, you guessed it, so did the rest of the family. Parents, huh?

NEEDS 1.5 MEG

Hugh Grove's excellent *Thunderbirds Are Gone* tells an unusual tale based on the antics of Tracy Island, and features Thunderbirds 1, 2 and 3 along with Scott Tracy.

There's been an oil spillage, and the Thunderbirds are called out. Unfortunately, Scott's Dad has suffered some kind of brain-storm and has ordered all the ships to exactly the same destination, causing a three-way collision course. This is made worse because Scott has pressed the button 'which makes the ship go really, really fast'. Oh, no! What will become of poor Scott? Well you'll just have to get the demo to find out.

Although this is only his third notable demo, Grove's work is recognisable a mile off. Clear, uncomplicated graphics, excellent story-line and some spot-on sound effects are becoming a trademark of his work. Superb.

STATE OF THE ART
CYNOSTIC PD, DISK D0031

1 MEG CHIP RAM

Wow! After seeing *Jesus on E's* last month, we figured nothing could better it. Yet here, we have a demo by Spaceballs that is set to light up Amigas everywhere. The music is quite ravey, but it's not up to the standard of *Jesus*. Where *State of the Art* shines is in its graphics.

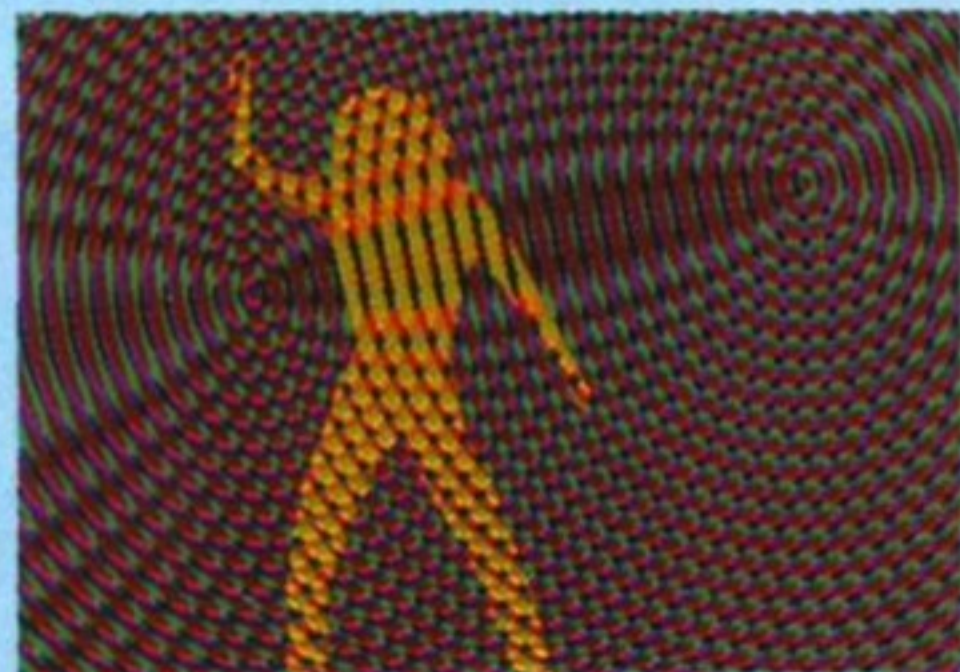

This is the kind of flashy, stroby demo we like in AF...

Stunningly quick vector polygons display a variety of dancers, in a James Bond-style silhouette, who are sequenced to the music. After a dancer has strutted away, it is quickly morphed into another, and the transition is so smooth it's incredible.

If that weren't enough, beautiful copper backgrounds complement the constantly changing graphics. These demos are becoming an art form.

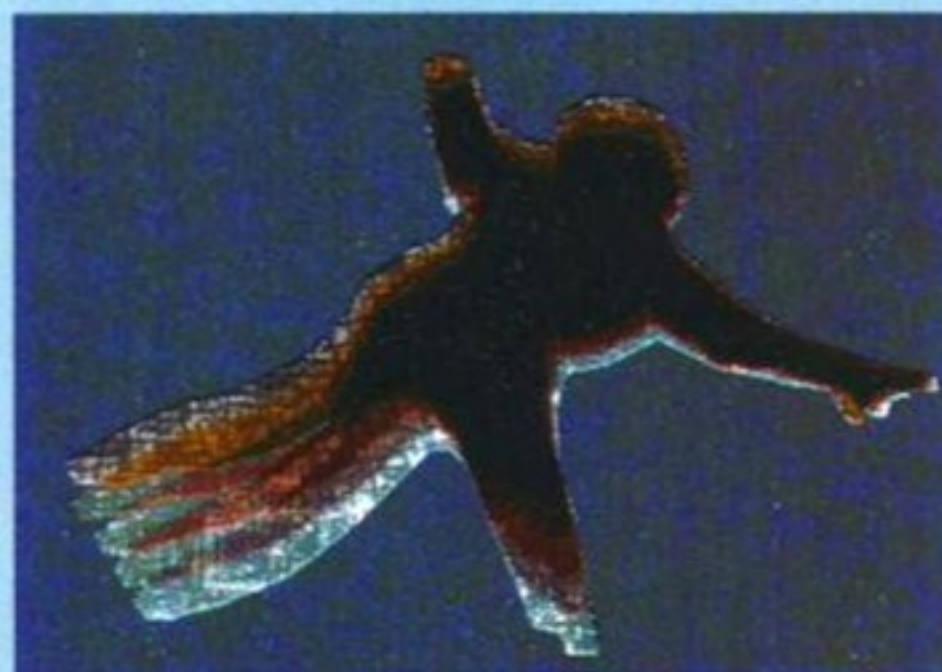

...but still frames can't convey the effect of the demo.

PD OR NOT PD?

Although the following two titles are available from popular PD houses, they are not actually public domain. They are, in fact, two pieces of work from well-known demo authors Tobias Richter and Bjorn A Lynne, which are distributed through PD companies. Don't go giving copies to your friends, it's illegal and dishonest - so don't do it.

SPACE WARS

VIDEO

17-BIT, VHS VIDEO, £11.99

Hands up all those of you who have heard of Tobias Richter. One, two, three... 161255,



The powerful piece of space machinery is foiled by a falling drinks can flipping the 'self-destruct' button...

HOBBITS & SPACESHIPS

CD

CYNOSTIC PD, AUDIO CD, £9.99

When Bjorn A Lynne, aka Dr Awesome, teams up with Seppo Hurme, aka Fleshbrain, what do you get? A CD of music created using Amiga samples and external MIDI instruments, featuring some pro-

161256. That's about right, because just about everyone who reads *Amiga Format* must have seen screenshots of his work from time to time. He's an animator of course, who uses several Amigas to create stupendously complex ray-traced animations. Demos featuring Richter animations have been around for years, but *Space Wars* is the result of months of work, culminating in a seven-minute long animation.

Although the storyline is pretty strong, what strikes you immediately is the quality of the graphics. There are 8,000 frames of superb, true-colour rendering using DCTV with *Reflections 2* and



...the Millennium Falcon, the Starship Enterprise and assorted X-Wing fighters prepare to do battle...

fessionally recorded music fitting neatly into the 'progressive rock' genre.

From the soft, whispering intro of *Diminuendo*, to the hard, funky rhythm of *Graveyard (Part III)*, the two musicians cover a range of musical styles, using their instruments to good effect - especially the samples used on *Graveyard*. The music is distinctly reminiscent of

Videoscape 2, which took five Amigas around four weeks to complete. Add this on to the six weeks it took to do the original modelling, and you get a feel for the work which has gone into the production.

As mentioned earlier there is a good storyline, which involves ships from *Star Wars* and *Star Trek* destroying a moon in deepest space. It's sometimes cute, sometimes witty, but always technically stunning. If you want to find out just what's possible with an Amiga, this is the video to own. Oh, by the way, the soundtrack for the video was written by Bjorn A Lynne who, coincidentally, wrote the contents of the next review...



...but the X-Wings run into a spot of bother. Negotiating an asteroid belt is not a job for the faint-hearted.

the later work of Bill Nelson (*Scala, BeBop Deluxe*) in parts, which can only be a good thing.

OK, so it's not going to be everybody's cup of tea, but it is an interesting collection of music, created using an Amiga and *Music-X*. Worth checking out if you're remotely interested in progressive rock, or if you want to hear yet another area in which the Amiga is being put to good use.

CINEMORPH

NBS

ANIM

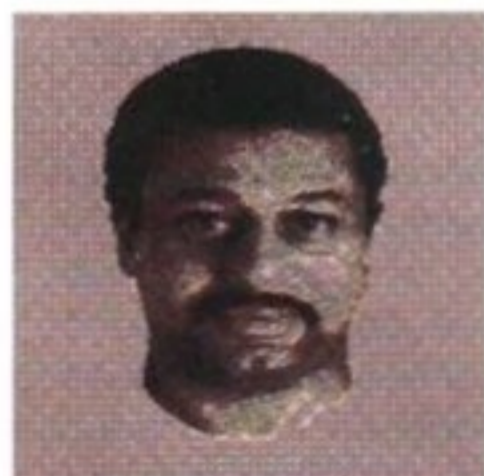

"And this week on *Crimewatch...*", Vark's friends and family sure paint an interesting picture (untrue).

As far as morphing is concerned, last month it was the turn of Michael Jackson's *Black and White* video, digitised straight from television. This month we have an original creation. Using *CineMorph*, GVP's new morphing utility, Amiga animator Vark has digitised the faces of four people, and morphed them together. It's nicely done, and although it only uses monochrome interlaced mode it shows what is possible using a standard A500. Given that the graphical power of the new A1200 is so much better, this could give even Michael Jackson videos a run for their money.

CULT TV VOLUME 2

DEMO

17-BIT, DISKS 2346 A&B

Here's one for fans of early cult TV series. Using *HyperBook*, Chris Murphy has drawn from what must be a vast knowledge of such shows as *The Prisoner*, *Thunderbirds* and *The Twilight Zone*, and created a database packed with TV trivia. The sheer completeness of the information is very impressive. For instance, 151 episodes of the original *Twilight Zone* series are listed; an incredibly impressive feat. I certainly wouldn't have known that the creator of the Daleks himself, Terry Nation, wrote seven of the 24 episodes of *The Persuaders*. A couple of noticeable omissions, however, cast a shadow of doubt over the information. David McCallum's TV history is listed as *Colditz*, *The Invisible Man* and *Frankenstein* - how could anyone forget *Sapphire and Steel*? ☺

Gerry Anderson
 Born: 1929.
 Film and TV include:
 Film: *Thunderbirds Are Go*, *Thunderbird 6*, *Journey to the Far Side of the Sun*.
 TV: *Four Feather Falls*, *Supercar*, *Fireball XL5*, *Stingray*, *Thunderbirds*, *Captain Scarlet*, *Joe 90*, *The Secret Service*, *UFO*, *Space 1999*. *
 * - Live action series.

Excellent! All your favourite *Thunderbirds* characters on one small screen - in super *Stretch-o-Vision*™...

TOP 10 DEMOS OF THE MONTH

Just so that you know what's in and what's not we ask a Public Domain library to tell us what there most 10 popular disks are this month...

MERCURY PD - 0375 845280

- | | | |
|-----|-----------------------------|-----------------|
| 1. | Jesus on E's | D123.1 & D124.1 |
| 2. | Budbrain Megademo | D20 & D21.3 |
| 3. | Odyssey | D99.1 - D103.1 |
| 4. | Anti-Lemmin' Demo | D130.2&D131.2 |
| 5. | Pulling the Trigger | D92.3 |
| 6. | Alcatraz Megademo | D47.3 - D49.3 |
| 7. | Cool Cougar | D23.5 |
| 8. | Boris Valejo's Slideshow 2 | D141.2 & D142.2 |
| 9. | Pink Floyd's The Wall | D133.1 - D138.1 |
| 10. | Popeye Meets The Beach Boys | D1.2 |

WHERE TO GET THE DISKS IN THIS ISSUE

NBS: 1 Chain Lane, Newport, Isle Of Wight PO33 2QQ. 0983 529594

17-BIT: 2-8 Market Street, Wakefield, West Yorkshire WF1 1DH. 0924 366982

CYNOSTIC PD: 85 Wyken Croft, Coventry CV2 3AD. 0203 613817

CUT, TICK & POST... CUT, TICK & POST



Telephone or Fax Hotline (0702) 466933

PD Soft (AF44) 1 Bryant Ave, Southend-on-Sea, ESSEX, SS1 2YD

EDUCATION

JX V13 PLAY & READ CHALLENGE (2) Education program for the under 7's
JX V546 KIDS PAINT A painting program designed for children. Includes various colours & speech.
JX V584 FASTFACTS, Everything you ever needed to know about the solar system. **WORLDMAP** Produces different sorts of Maps. **PLANETS** Instant locations
JX V737 ENGINES A set of Animations which gives the basic engine knowledge (3)
JX V776 AMOS LESSON 1 The best Amos Tutorial program. (APD151)
JX V792 KIDS GAMES Includes Geography, Math, Science and Word Games. Also contains Wheel of Fortune.
JX V793 AMIGA BEGINNER You asked for it! A tutorial for the beginner on using your Amiga! Covers CU & WB.
JX V824 ELEMENT v3.0 Nice interactive display of the Periodic Table of Elements.
JX V825 WORLD DATA BANK v2.2 Using a database of coordinates of the CIA's world maps in cylindrical or spherical projects, various degrees of magnification.
JX V843 DESERT STORM You can select Map's, and all information surrounding the Desert Storm Attack.
JX V849 LANGUAGE TUTOR v1.0 Spanish, French, German & Italian.
JX V881 SECOND WORLD WAR Excellent information production.
JX V908 DELUXE PAINT TUTOR Do you had Paint. Then learn to use it.
JX V927 CU TUTOR Helpful program to understand how to use CU/Shell.
JX V933 GESE MATHS Maths prog to help with the GESE maths course.
JX V940 MATHSAID Simple math problems to solve. REFLEXTEST Tests addition, subtraction & multiplication.
JX V941 AMIGA FIRST START Help on any subject you want - Easy Start!
JX LP29 BIG TOP FUN 4 progs to help children with words & pictures. £4.99
JX LP37 ROCKET MATHEMATICS Tables, Takeaway, Add up & Divide. £4.99
JX LP45 MUSIC BOX Excellent interactive music. £4.99
JX LP59 PREHISTORIC FUN Who likes Dinosaurs? Everyone. Four great games based round Dinosaurs. £4.99
JX LP113 UNDERSTANDING 2 (2) Learn how to program AMOS. £8.99
JX LP119 YIPPEE Perfect platform game for children which features a Rhino, a crocodile, a cheetah and a crocodile. £4.99
JX LP122 TELL THE TIME Many children have difficulty learning how to tell the time. Help is at hand. £4.99

VIDEO PRODUCTION

JX V48 TV & VIDEO Contains background screens for your video productions. Many types of graphic styles. Peel, Takes an IFF Pic & peels it down the screen. (8)
JX V86 VIDEO PRODUCTION 1-2 (2) Packed with video & Genlock utilities.
JX V415 VIDEO SCREENS - 1 Back ground pictures for video production.
JX V517 VIDEO DB Program for keeping track on your video tape collections.
JX V518 IMAGE LAB This program is like a mini Art DEPT. Tools On Top Does fades, colourbars & gray bar.
JX V519 VIDEO: STILLSTORE Used to create over the shoulder graphic inserts like the 9'0 clock news.
JX V636 SHADES & FADES ANIM FADER. A utility to fade screens in & out. TURBOTITLE. Create subtitles.
JX V677 ANDROIDS VIDEO BACK GROUND Selection of B/G Pictures.
JX V687 VIDEO WIPES A collection of IFF Brushes & background graphic effects.
JX V693 HARLEQUIN VIDEO ART & FONT DISKS A video production with excellent backgrounds & Fonts (3)
JX V818 INSCRIPT v1.1 Produce video titles. Features include fully editable text entry, IFF Pics as back grounds, Unlimited number of fonts loaded, outline support (WB2.04), text styles & cycling, all resolutions.
JX V829 VIDEO PRODUCTION 3-4 This is the latest collection of the New video related utilities. Excellent (2)
JX V868 GENETATED ART Excellent collection of background pictures.
JX V874 VIDEO TITLER PRODUCTION Utilities for generating video Titles.
JX L27 VIDEO TEXTURES Like Black marble, BrickWork, Roughness, Marble, Tiles, Water ripples & Wood. £3.50
JX LP75 VIDEO LAB v1.0 Simple to use video tiling package. Genlock is not required. Req Two Drives £4.99
JX FFP10 FLETCHER FONTS A three disk pack of 50 - 100 point 16 colour Video Fonts. Includes templates £9.99

VARIOUS UTILITIES

JX V16 FISH TANK SIM A program that simulates an aquarium.
JX V109 PRINT STUDIO Excellent for printing graphic pictures or just text.
JX V191 MASTER VIRUS KILLER Virus Checker & Killer. With excellent options.
JX V194 M.R.BACKUP HD Hard disk backup program with compression.
JX V215 DISKMASTER v3.2 Copies files from one disk to another. DISK SALV Corrects & repairs bad tracks.
JX V262 DUPLICATION & BACKUP Super Duper, Turbo copy, Sanity copy & PCopy. Four new disk copiers.
JX V277 FORTRAN-77 v1.3c Compiler, linker & run time support libs.
JX V279 CROSSWORD CREATOR Creates crosswords. UPDATED VERSION.
JX V284 MCAD PROGRAM The Object Drawing Program. ie C.A.D.
JX V298 NORTH C v1.3 (2) C language / Amiga. Includes all files required.
JX V301 EYE OF THE BEHOLDER HINT BOOK Introductory, Background, Maps, Strategy & Solution.
JX V323 ANALYTICAL SPREAD SHEET (2) The best spread sheet.
JX V332 AMIGA PUNT PROGRAM Predict which horse will win the race.
JX V339 SPECTRUM EMULATOR Data Disk 1. The Adventure Classics.
JX V350 BUSINESS CARD MAKER Design your own Business cards.
JX V366 600 BUSINESS LETTERS Over 600 Standard Business letters

JX V390 DESK TOP PUBLISHING Extra features, Text & Graphics Editors
JX V392 AMICASH BANKIN The best bank program that I have ever used on the Amiga. Very easy controls.
JX V394 CHEMESTICS v2.14 Program that draws molecules using the calotte model. Updated this Month
JX V401 WINDOWBENCH v1.0 (2) An excellent Workbench 2 replacement / Upgrade for all WB v1.3 users.
JX V413 WORKSTATION Not just another WB clone. It's a collection of utilities with the Workbench theme. (2)
JX V417 SUPERBENCH & EXTRAS (2) An excellent replacement disk with more utilities than the original.
JX V420 CURSOR BASIC COMPLIER Compile any Amiga Basic program
JX V424 ANTI-FLICKER Said to stop the flicker in High Res mode during some Amiga program operations.
JX V431 AMPOLODER v4.0 Reduces file size for storage on hard disks.
JX V433 ANIMATION STUDIO Make your own little animations.
JX V444 PRINTER DRIVER DISK III Now contains instructions on how to install them. Includes over 90
JX V479 CHESS & CHESS UTILITIES A collection of chess related Puzzles.
JX V484 ADVENTURE SOLUTIONS (2) Solutions for various games.
JX V489 AMIBASE PROFESSIONAL v2.0 Latest version of the excellent Database program. NEW FEATURES
JX V490 MESSY SID v2.0 Will read MS-Dos disks. Transfer any text files to & from the PC. So you can do work on an IBM or an Amiga & swap text.
JX V521 PLOTTING & GRAPHICS PLOTXY. A powerful full featured plotting prog. PLANS A. computer aided drafting prog. Requires ARP
JX V522 ARP v1.3: Conman v1.3c Makes many improvements to Dos. Includes full developers guide.
JX V523 DICE C COMPILER (2) Matthew Dillons full featured powerful C compiler & environment system.
JX V536 CATALOGUE UTILITIES A collection of utilities used to Catalog disk/ Video & Tape collections (2)
JX V560 DUPLICATION & BACKUP II A collection of copiers like Amiga Copy, Coder copy, PCopy, Ratfilecopy
JX V567 PRINTER DRIVER GENERATOR A selection of utilities with various excellent Printer Driver Generators.
JX V569 DUNGEON MASTER MAPPER v1.1 You can design maps, for dungeons & towns for use within any Advanced Dungeons & Dragons
JX V571 WHOM II v2.02 (2) Gives all info on Dr Who programs. DB
JX V573 FILE & HD MANAGEMENT HDCLICK v2.0, Selector to make Hard Disk Menus Starts with gadgets. FILE MINDER, For maintaining files & Directories. DOSCONTROL, Combines functions of many separate tools. (2)
JX V575 HOME BUSINESS PACK Excellent selection of utilities based on word processing, Data Management, Spread Sheets, Accounts & Printing. (6)
JX V583 ICONEDITOR III v2.0. Can create icons upto 640x200 pixels, icons. Edit & Create any Amiga icon
JX V587 GELIGNITE FONTS (2) A selection of fonts for use with any DTP Package or Dpoint disks.
JX V607 PRO TRACKER v2.2 Written by Lars Zap Hamre. Another update to the Ultimate sound making program.
JX V610 GOLF SCORES v1.84 It will record each round you play. Store it, make up an eclectic score NEW!
JX V611 FOOTBALL LEAGUE EDITOR v1.1 Want to update your teams league position as the results come in
JX V620 ASPICE v3.2 Circuit Analysis. A full featured program for electric circuit
JX V621 EDWORD v2.2 is a fully featured & operational Word processor
JX V624 NIB COPIER v2.0 Will copy in AmigaDos, index nibble modes, search mode & special parameter copy
JX V625 NCOM v2.0 Contains, JHArc v2.0, JHArca v1.02, Zoom v5.40, DMS v1.03, JHv4 v1.11, JHv5 v1.1
JX V627 DPAIN FONTS No's 1-3 (3) The latest selection. Fonts for use with any IFF Painting / DTP Program
JX V635 IBM EMULATOR v1.05 is a CGA Colour IBM-PC Emulator which is run on any Amiga. Shareware version
JX V647 HACKS A selection of WB Hacks that have been reviewed in CU
JX V648 TITANICS CRUNCHER v1.0 Cruncher with help & various protect modes includes speed changes.
JX V649 WP & SPELL CHECKING A Collection of utilities to help with your word processing needs. Spellcheckers
JX V659 COMPUTER DIAGNOSTICS v1.1 Is there a problem with your computer? Then what is it?
JX V660 HOME MANAGER This is a great all in one address book with an inventory database & To-do list
JX V661 VERTEX Allows you to create 3d objects with-out using the X, Y & Z views. Loads Sculpt 3d/4d & Turbo Silver.
JX V662 DCCOPY v3.0 PRO You can select the speed of the disk drive. Copy modes, Dos, Nibcopy, Ver & safecopy
JX V666 MODELLING OBJECTS (2) Contains over 20 vector objects in image format. Perfect with Disk V661
JX V678 DRAW MAP v4.1 (2) You can generate world maps in detail.
JX V679 DIRTY VIEWS Includes the most powerful and highly recommended programs which are designed to make CU & Shell tasks virtually obsolete.
JX V794 GRINDER A complete graphic conversion package that supports Gif, Png, Atari St Neochrome / Degast, PCK, Targa, Tiff, Ham-8 & IFF format pics.
JX V797 EASY AMOS PROGS (2) Contains source code for use with Easy Amos.
JX V799 ADVANCED UTILS SerNet & ParNet. Connected 2 Amiga & share resources via the serial / Parallel ports. Mymenu Puts menus on your Workbench screen.
JX V800 ARCHIVERS II This disk is packed with the latest Archivers to date

JX V806 WB v2.04 UTILITES (2) This is the our second double disk collection of WB v2.04+ utilities that take advantage of the NEW machines capabilities.
JX V809 MEGA CHEATS v2.1 This disk contains the very latest cheats.
JX V811 ELECTROCAD v1.42 & PROTOYPE Another Updated on the cod / Electronics drawing Programs.
JX V812 CANON This disk contains Printer Drivers & Canon Studio, Gives better print output for any 9 pin printer.
JX V814 PC TASK v1.11 is a software IBM-PC Emulator. Allows you to run the majority of IBM software with NO additional hardware. CGA Colour NEW UPDATE
JX V815 FILE & HD MANAGEMENT 2: DirWork v1.62 File copier MegaD
JX V816 CRYPTOR Another NEW Update on an excellent File copier like the NEW Disk Master Pro II in it's Operations. Also contains loads of other programs to help out (2)
JX V817 A500 PLUS EMULATOR As it sounds will let v1.3 / v1.2 owners run WB v2.04+ software with out any need to purchase to WB v2.0+ chips
JX V819 ICONAUTHOR v1.06 Replacement for iconedit2.0. It can transform IFF or brushes into resized 2-8Plane brushes or icon files that match the WB v2.04+ colours.
JX V820 BBBBS v5.7 Baud bondif bulletin board System Funes include up to 99 file libraries, interface to extra disks.
JX V821 SNOOPDOS v1.5 Monitors AmigaDos calls & allows you to see what I/O devices, fonts are required.
JX V822 BACKUP v3.77 A hard drive backup program that features, multi-disk support, full backup, compression
JX V823 POWERPLAYER v3.4 Very powerful, user / system friendly module player. It can handle nearly all module formats can read PP modules & comes with it's own cruncher.
JX V824 WHOM v3.4 Hard Drive Menu. When placed in your startup-sequence, offers a 16 page menu, each page having upto 10 possible actions.
JX V825 DISKPRINT v3.51 A label database which prints & stores disk labels, combined database & print utility for disks. Works fine with every printer.
JX V827 BOOT INTRO CONSTRUCT ION SET Create excellent Boot Intros
JX V824 PRINTER DRIVERS v4 This is an updated Drivers disk. Canon LPB, Canon Bubble jets & Star 9 pin.
JX V825 THE SUPER KILLERS v2.6: BOOT X v4.50 This is the best virus killer disk to date, kills over 262 virus & may be more. Includes many others
JX V827 ART OF MED 2 Another excellent selection of Med tunes.
JX V830 ICON MANIA An excellent selection of icon clip Art for your WB Disk
JX V831 AMOSBROT v1.1a More fractal types which include Logistic Equations, Coast lines & trees
JX V832 WORKBENCH v2.04+ UTILITIES 3 DCCopy, Boot menu writer, I-Pic, Scenery, Huge, GED.
JX V833 SOFTWARE LISTER v1.6 This program is designed to keep a track of your Software collection.
JX V835 MEMORY MANAGER v1.1 Select any amount of Chip / fast ram
JX V842 ONLINE v1.4 Program will allow you to find cheats within games
JX V843 TERM v2.3 Best Communications program for use with WB v2.04+ (2)
JX V849 THE PROFESSIONAL C MANUAL v3.0 This is the largest collection of documents, examples & utilities in C for the Amiga. It consists of 6 manuals, with more than 40 chapters, 175 fully executable examples complete with source codes. (5)
JX V857 AMIGADEX v1.61 Creates / converts your Amiga into a word Database system. Very well done.
JX V858 TEXTPLUS v4.0e Another update of this excellent Word processor program. Needs Unruncher
JX V859 TEXT ENGINE v3.4 Updated version of the Word processor with AZSPELL. Excellent spell checker
JX V860 BOOTH v5.03 An easy to use boot, file and link virus killer. Has lots of options to detect & kill Amiga Viruses.
JX V861 A-GENE v4.18 The latest version of the popular genealogy database program. By Mike Simpson
JX V862 BBBASE v5.5 Simple database will extra features like fast searches, mailing label support, and best of all it's easy to use. Max 9 Fields
JX V870 ACCOUNT MASTER v1.02 Excellent Amos written Account program
JX V873 WB v2.04 WINDOWBENCH v2.0. Excellent Workbench replacement for all WB v2.04+ Rom Users (2)
JX V877 VIDEO CU v5.0. The idea is to control the CU/Shell with your own voice.
JX V878 RAYSHADE v4.0 Complex Ray tracing package 2Mb (3)
JX V872 FORMS Create, Edit, Draw Colour & print your own forms
JX V873 PROGRAMMING TOOLBOX Many programs to help in your development efforts (most C but some in basic).
JX V874 AREXX (2) Two disks which contain Arexx programs & examples
JX V876 PASCAL This disk contains everything needed to program in Pascal. Includes as8k 68000 assembler & more.
JX V877 PROGRAMMER TOOLS GodTools to design your user interface to your own programs using all of Amiga DOS 2.0+ new features. Also RegTools.
JX V879 ANIMATION UTLS Includes CyoJNils for splitting, combining, and creating animations from IFF picture files.
JX V891 DIRECTORY ULTS Includes the most powerful and highly recommended programs which are designed to make CU & Shell tasks virtually obsolete.
JX V794 GRINDER A complete graphic conversion package that supports Gif, Png, Atari St Neochrome / Degast, PCK, Targa, Tiff, Ham-8 & IFF format pics.
JX V797 EASY AMOS PROGS (2) Contains source code for use with Easy Amos.
JX V799 ADVANCED UTILS SerNet & ParNet. Connected 2 Amiga & share resources via the serial / Parallel ports. Mymenu Puts menus on your Workbench screen.
JX V800 ARCHIVERS II This disk is packed with the latest Archivers to date

JX V806 WB v2.04 UTILITES (2) This is the our second double disk collection of WB v2.04+ utilities that take advantage of the NEW machines capabilities.
JX V809 MEGA CHEATS v2.1 This disk contains the very latest cheats.
JX V811 ELECTROCAD v1.42 & PROTOYPE Another Updated on the cod / Electronics drawing Programs.
JX V812 CANON This disk contains Printer Drivers & Canon Studio, Gives better print output for any 9 pin printer.
JX V814 PC TASK v1.11 is a software IBM-PC Emulator. Allows you to run the majority of IBM software with NO additional hardware. CGA Colour NEW UPDATE
JX V815 FILE & HD MANAGEMENT 2: DirWork v1.62 File copier MegaD
JX V816 CRYPTOR Another NEW Update on an excellent File copier like the NEW Disk Master Pro II in it's Operations. Also contains loads of other programs to help out (2)
JX V817 A500 PLUS EMULATOR As it sounds will let v1.3 / v1.2 owners run WB v2.04+ software with out any need to purchase to WB v2.0+ chips
JX V819 ICONAUTHOR v1.06 Replacement for iconedit2.0. It can transform IFF or brushes into resized 2-8Plane brushes or icon files that match the WB v2.04+ colours.
JX V820 BBBBS v5.7 Baud bondif bulletin board System Funes include up to 99 file libraries, interface to extra disks.
JX V821 SNOOPDOS v1.5 Monitors AmigaDos calls & allows you to see what I/O devices, fonts are required.
JX V822 BACKUP v3.77 A hard drive backup program that features, multi-disk support, full backup, compression
JX V823 POWERPLAYER v3.4 Very powerful, user / system friendly module player. It can handle nearly all module formats can read PP modules & comes with it's own cruncher.
JX V824 WHOM v3.4 Hard Drive Menu. When placed in your startup-sequence, offers a 16 page menu, each page having upto 10 possible actions.
JX V825 DISKPRINT v3.51 A label database which prints & stores disk labels, combined database & print utility for disks. Works fine with every printer.
JX V827 ART OF MED 2 Another excellent selection of Med tunes.
JX V830 ICON MANIA An excellent selection of icon clip Art for your WB Disk
JX V831 AMOSBROT v1.1a More fractal types which include Logistic Equations, Coast lines & trees
JX V832 WORKBENCH v2.04+ UTILITIES 3 DCCopy, Boot menu writer, I-Pic, Scenery, Huge, GED.
JX V833 SOFTWARE LISTER v1.6 This program is designed to keep a track of your Software collection.
JX V835 MEMORY MANAGER v1.1 Select any amount of Chip / fast ram
JX V842 ONLINE v1.4 Program will allow you to find cheats within games
JX V843 TERM v2.3 Best Communications program for use with WB v2.04+ (2)
JX V849 THE PROFESSIONAL C MANUAL v3.0 This is the largest collection of documents, examples & utilities in C for the Amiga. It consists of 6 manuals, with more than 40 chapters, 175 fully executable examples complete with source codes. (5)
JX V857 AMIGADEX v1.61 Creates / converts your Amiga into a word Database system. Very well done.
JX V858 TEXTPLUS v4.0e Another update of this excellent Word processor program. Needs Unruncher
JX V859 TEXT ENGINE v3.4 Updated version of the Word processor with AZSPELL. Excellent spell checker
JX V860 BOOTH v5.03 An easy to use boot, file and link virus killer. Has lots of options to detect & kill Amiga Viruses.
JX V861 A-GENE v4.18 The latest version of the popular genealogy database program. By Mike Simpson
JX V862 BBBASE v5.5 Simple database will extra features like fast searches, mailing label support, and best of all it's easy to use. Max 9 Fields
JX V870 ACCOUNT MASTER v1.02 Excellent Amos written Account program
JX V873 WB v2.04 WINDOWBENCH v2.0. Excellent Workbench replacement for all WB v2.04+ Rom Users (2)
JX V877 VIDEO CU v5.0. The idea is to control the CU/Shell with your own voice.
JX V878 RAYSHADE v4.0 Complex Ray tracing package 2Mb (3)
JX V872 FORMS Create, Edit, Draw Colour & print your own forms
JX V873 PROGRAMMING TOOLBOX Many programs to help in your development efforts (most C but some in basic).
JX V874 AREXX (2) Two disks which contain Arexx programs & examples
JX V876 PASCAL This disk contains everything needed to program in Pascal. Includes as8k 68000 assembler & more.
JX V877 PROGRAMMER TOOLS GodTools to design your user interface to your own programs using all of Amiga DOS 2.0+ new features. Also RegTools.
JX V879 ANIMATION UTLS Includes CyoJNils for splitting, combining, and creating animations from IFF picture files.
JX V891 DIRECTORY ULTS Includes the most powerful and highly recommended programs which are designed to make CU & Shell tasks virtually obsolete.
JX V794 GRINDER A complete graphic conversion package that supports Gif, Png, Atari St Neochrome / Degast, PCK, Targa, Tiff, Ham-8 & IFF format pics.
JX V797 EASY AMOS PROGS (2) Contains source code for use with Easy Amos.
JX V799 ADVANCED UTILS SerNet & ParNet. Connected 2 Amiga & share resources via the serial / Parallel ports. Mymenu Puts menus on your Workbench screen.
JX V800 ARCHIVERS II This disk is packed with the latest Archivers to date

JX V806 WB v2.04 UTILITES (2) This is the our second double disk collection of WB v2.04+ utilities that take advantage of the NEW machines capabilities.
JX V809 MEGA CHEATS v2.1 This disk contains the very latest cheats.
JX V811 ELECTROCAD v1.42 & PROTOYPE Another Updated on the cod / Electronics drawing Programs.
JX V812 CANON This disk contains Printer Drivers & Canon Studio, Gives better print output for any 9 pin printer.
JX V814 PC TASK v1.11 is a software IBM-PC Emulator. Allows you to run the majority of IBM software with NO additional hardware. CGA Colour NEW UPDATE
JX V815 FILE & HD MANAGEMENT 2: DirWork v1.62 File copier MegaD
JX V816 CRYPTOR Another NEW Update on an excellent File copier like the NEW Disk Master Pro II in it's Operations. Also contains loads of other programs to help out (2)
JX V817 A500 PLUS EMULATOR As it sounds will let v1.3 / v1.2 owners run WB v2.04+ software with out any need to purchase to WB v2.0+ chips
JX V819 ICONAUTHOR v1.06 Replacement for iconedit2.0. It can transform IFF or brushes into resized 2-8Plane brushes or icon files that match the WB v2.04+ colours.
JX V820 BBBBS v5.7 Baud bondif bulletin board System Funes include up to 99 file libraries, interface to extra disks.
JX V821 SNOOPDOS v1.5 Monitors AmigaDos calls & allows you to see what I/O devices, fonts are required.
JX V822 BACKUP v3.77 A hard drive backup program that features, multi-disk support, full backup, compression
JX V823 POWERPLAYER v3.4 Very powerful, user / system friendly module player. It can handle nearly all module formats can read PP modules & comes with it's own cruncher.
JX V824 WHOM v3.4 Hard Drive Menu. When placed in your startup-sequence, offers a 16 page menu, each page having upto 10 possible actions.
JX V825 DISKPRINT v3.51 A label database which prints & stores disk labels, combined database & print utility for disks. Works fine with every printer.
JX V827 ART OF MED 2 Another excellent selection of Med tunes.
JX V830 ICON MANIA An excellent selection of icon clip Art for your WB Disk
JX V831 AMOSBROT v1.1a More fractal types which include Logistic Equations, Coast lines & trees
JX V832 WORKBENCH v2.04+ UTILITIES 3 DCCopy, Boot menu writer, I-Pic, Scenery, Huge, GED.
JX V833 SOFTWARE LISTER v1.6 This program is designed to keep a track of your Software collection.
JX V835 MEMORY MANAGER v1.1 Select any amount of Chip / fast ram
JX V842 ONLINE v1.4 Program will allow you to find cheats within games
JX V843 TERM v2.3 Best Communications program for use with WB v2.04+ (2)
JX V849 THE PROFESSIONAL C MANUAL v3.0 This is the largest collection of documents, examples & utilities in C for the Amiga. It consists of 6 manuals, with more than 40 chapters, 175 fully executable examples complete with source codes. (5)
JX V857 AMIGADEX v1.61 Creates / converts your Amiga into a word Database system. Very well done.
JX V858 TEXTPLUS v4.0e Another update of this excellent Word processor program. Needs Unruncher
JX V859 TEXT ENGINE v3.4 Updated version of the Word processor with AZSPELL. Excellent spell checker
JX V860 BOOTH v5.03 An easy to use boot, file and link virus killer. Has lots of options to detect & kill Amiga Viruses.
JX V861 A-GENE v4.18 The latest version of the popular genealogy database program. By Mike Simpson
JX V862 BBBASE v5.5 Simple database will extra features like fast searches, mailing label support, and best of all it's easy to use. Max 9 Fields
JX V870 ACCOUNT MASTER v1.02 Excellent Amos written Account program
JX V873 WB v2.04 WINDOWBENCH v2.0. Excellent Workbench replacement for all WB v2.04+ Rom Users (2)
JX V877 VIDEO CU v5.0. The idea is to control the CU/Shell with your own voice.
JX V878 RAYSHADE v4.0 Complex Ray tracing package 2Mb (3)
JX V872 FORMS Create, Edit, Draw Colour & print your own forms
JX V873 PROGRAMMING TOOLBOX Many programs to help in your development efforts (most C but some in basic).
JX V874 AREXX (2) Two disks which contain Arexx programs & examples
JX V876 PASCAL This disk contains everything needed to program in Pascal. Includes as8k 68000 assembler & more.
JX V877 PROGRAMMER TOOLS GodTools to design your user interface to your own programs using all of Amiga DOS 2.0+ new features. Also RegTools.
JX V879 ANIMATION UTLS Includes CyoJNils for splitting, combining, and creating animations from IFF picture files.
JX V891 DIRECTORY ULTS Includes the most powerful and highly recommended programs which are designed to make CU & Shell tasks virtually obsolete.
JX V794 GRINDER A complete graphic conversion package that supports Gif, Png, Atari St Neochrome / Degast, PCK, Targa, Tiff, Ham-8 & IFF format pics.
JX V797 EASY AMOS PROGS (2) Contains source code for use with Easy Amos.
JX V799 ADVANCED UTILS SerNet & ParNet. Connected 2 Amiga & share resources via the serial / Parallel ports. Mymenu Puts menus on your Workbench screen.
JX V800 ARCHIVERS II This disk is packed with the latest Archivers to date

JX V806 WB v2.04 UTILITES (2) This is the our second double disk collection of WB v2.04+ utilities that take advantage of the NEW machines capabilities.
JX V809 MEGA CHEATS v2.1 This disk contains the very latest cheats.
JX V811 ELECTROCAD v1.42 & PROTOYPE Another Updated on the cod / Electronics drawing Programs.
JX V812 CANON This disk contains Printer Drivers & Canon Studio, Gives better print output for any 9 pin printer.
JX V814 PC TASK v1.11 is a software IBM-PC Emulator. Allows you to run the majority of IBM software with NO additional hardware. CGA Colour NEW UPDATE
JX V815 FILE & HD MANAGEMENT 2: DirWork v1.62 File copier MegaD
JX V816 CRYPTOR Another NEW Update on an excellent File copier like the NEW Disk Master Pro II in it's Operations. Also contains loads of other programs to help out (2)
JX V817 A500 PLUS EMULATOR As it sounds will let v1.3 / v1.2 owners run WB v2.04+ software with out any need to purchase to WB v2.0+ chips
JX V819 ICONAUTHOR v1.06 Replacement for iconedit2.0. It can transform IFF or brushes into resized 2-8Plane brushes or icon files that match the WB v2.04+ colours.
JX V820 BBBBS v5.7 Baud bondif bulletin board System Funes include up to 99 file libraries, interface to extra disks.
JX V821 SNOOPDOS v1.5 Monitors AmigaDos calls & allows you to see what I/O devices, fonts are required.
JX V822 BACKUP v3.77 A hard drive backup program that features, multi-disk support, full backup, compression
JX V823 POWERPLAYER v3.4 Very powerful, user / system friendly module player. It can handle nearly all module formats can read PP modules & comes with it's own cruncher.
JX V824 WHOM v3.4 Hard Drive Menu. When placed in your startup-sequence, offers a 16 page menu, each page having upto 10 possible actions.
JX V825 DISKPRINT v3.51 A label database which prints & stores disk labels, combined database & print utility for disks. Works fine with every printer.
JX V827 ART OF MED 2 Another excellent selection of Med tunes.
JX V830 ICON MANIA An excellent selection of icon clip Art for your WB Disk
JX V831 AMOSBROT v1.1a More fractal types which include Logistic Equations, Coast lines & trees
JX V832 WORKBENCH v2.04+ UTILITIES 3 DCCopy, Boot menu writer, I-Pic, Scenery, Huge, GED.
JX V833 SOFTWARE LISTER v1.6 This program is designed to keep a track of your Software collection.
JX V835 MEMORY MANAGER v1.1 Select any amount of Chip / fast ram
JX V842 ONLINE v1.4 Program will allow you to find cheats within games
JX V843 TERM v2.3 Best Communications program for use with WB v2.04+ (2)
JX V849 THE PROFESSIONAL C MANUAL v3.0 This is the largest collection of documents, examples & utilities in C for the Amiga. It consists of 6 manuals, with more than 40 chapters, 175 fully executable examples complete with source codes. (5)
JX V857 AMIGADEX v1.61 Creates / converts your Amiga into a word Database system. Very well done.
JX V858 TEXTPLUS v4.0e Another update of this excellent Word processor program. Needs Unruncher
JX V859 TEXT ENGINE v3.4 Updated version of the Word processor with AZSPELL. Excellent spell checker
JX V860 BOOTH v5.03 An easy to use boot, file and link virus killer. Has lots of options to detect & kill Amiga Viruses.
JX V861 A-GENE v4.18 The latest version of the popular genealogy database program. By Mike Simpson
JX V862 BBBASE v5.5 Simple database will extra features like fast searches, mailing label support, and best of all it's easy to use. Max 9 Fields
JX V870 ACCOUNT MASTER v1.02 Excellent Amos written Account program
JX V873 WB v2.04 WINDOWBENCH v2.0. Excellent Workbench replacement for all WB v2.04+ Rom Users (2)
JX V877 VIDEO CU v5.0. The idea is to control the CU/Shell with your own voice.
JX V878 RAYSHADE v4.0 Complex Ray tracing package 2Mb (3)
JX V872 FORMS Create, Edit, Draw Colour & print your own forms
JX V873 PROGRAMMING TOOLBOX Many programs to help in your development efforts (most C but some in basic).
JX V874 AREXX (2) Two disks which contain Arexx programs & examples
JX V876 PASCAL This disk contains everything needed to program in Pascal. Includes as8k 68000 assembler & more.
JX V877 PROGRAMMER TOOLS GodTools to design your user interface to your own programs using all of Amiga DOS 2.0+ new features. Also RegTools.
JX V879 ANIMATION UTLS Includes CyoJNils for splitting, combining, and creating animations from IFF picture files.
JX V891 DIRECTORY ULTS Includes the most powerful and highly recommended programs which are designed to make CU & Shell tasks virtually obsolete.
JX V794 GRINDER A complete graphic conversion package that supports Gif, Png, Atari St Neochrome / Degast, PCK, Targa, Tiff, Ham-8 & IFF format pics.
JX V797 EASY AMOS PROGS (2) Contains source code for use with Easy Amos.
JX V799 ADVANCED UTILS SerNet & ParNet. Connected 2 Amiga & share resources via the serial / Parallel ports. Mymenu Puts menus on your Workbench screen.
JX V800 ARCHIVERS II This disk is packed with the latest Archivers to date

JX V924 PLOT MAP v0.85 An extra for use with draw map v4.0 or v4.1
JX V925 SLAUGHTER CHEATS Another selection of Hacks & Cheats on the best disks of the present time
JX V936 LETTERS & BOILERPLATE More Standard letters for you to use as your own or cut & paste.
JX V939 ANIM PB v1.2 Will show long sequences of animations or pictures from memory or disk.
JX V942 SCREEN BLANKERS A disk packed with various screen blankers.
JX V943 LYAPUNOVIA v1.0 A mind-bogglingly colourful program that makes pictures from a mathematical formula. Candy to mean metal.

REGISTERED VERSIONS

JX THE COMPLETE A64 PACKAGE v2.0 With interface & Full Commercial software. Transfers disks from your original 64 drive. This is a Full registered version of the Software £44.99

ERIC SCHWARTZ

JX 1700 ANTI-LEMMINGS (2) 2Mb
JX 2133 GULF WAR CONFLICT 2Mb
JX 2307 AMY AT THE MOVIES II (4)
JX 2311 AMY vs WALKER II (2) 3Mb
JX 2384 AMY AT THE BEACH (2) 3Mb
JX 2477 AMYWALKS
JX 2478 UNSPORTING 2Mb
JX 2500 THE SKY DRIVE * GAMES

J 1073 TETRIS ORIGINAL This is the closest game to the original tetris
JX 1420 DTRIS if you want a 1 or 2 player Tetris this has to be 1 of them.
JX 1561 TRITVUS Contains 1 player, 2 player & 3 Player game options.
JX 1735 ASTEROIDS 'THE ORIGINAL' Another old classic. Original classic
J 1747 LLAMATRON GAME 2001 By Jeff Minter & an excellent production
JX 1749 SCRAMBLE The Original! Remember that old classic game
JX 1870 PATIENCE'S Play vs the computer or another human player.
JX 1977 POM POM GUNNER Shoot down the incoming world war II air planes in this Operation Wolf game
J 2018 JETMAN Another Spectrum classic converted to the Amiga. It's JetPak with all the original sounds.
JX 2022 SEA LANCE The first Silent Service type sub war game on PD
JX 2054 ATIC ATAC A rendition of the game from the original Spectrum
JX 2162 BATTLE OF BRITAIN WAR GAME 2 Strategy war games
JX 2164 DUNGEON ON NADROJ This is the best Dungeons & Dragons Public domain type game. Load Wb
JX 2199 PARACHUTE JOUST You are falling down to earth & must take the Parachute from the other player
JX 2220 STRATEGIC GAMES Eternal Rome, Lords of Hosts, in Moonshine
JX 2221 MIND GAMES 21 of the best games to challenge your mind not your shooting skills. What a change
J 2224 SWORD OF THE WARLOCK A Bards tales / Eye of the Beholder adventure game packed on three disks. This is Shareware. (3) 1Mb (2 Drives)
JX 2272 BLACK JACK LAB Play all the popular versions of Pontoon
JX 2278 CARD SHARP A very professionally presented selection of solitaire type card games. Excellent
JX 2279 SUB ATTACK v1.0 Control the torpedoes & sink the enemy ships as they sail past. LAND

ALL DISKS NOW ONLY £1.05 EACH!

All disks work with the A1200! unless stated

(%) = Magazine review score

Anglia PD

(I) = LASER PRINTED INSTRUCTIONS AVAILABLE! JUST ADD 50p!

Catalogue Disk (P) only 70p - Includes a superb Scenery Generator!

(P) = Works on A500, A500 Plus and A600

HOME MANAGEMENT PACK 3 DISKS (P) £3.15
Calendar, Mortgage, Spreadsheet, Grammar, Mileage, World Time, Budget, Chequebook, Database, Typing Tutor, Typewriter, Grocery, List Maker, Home Banking.

CLIPART PACKS 1, 2 OR 3 EACH PACK = 5 DISKS £5.25
3 different packs of 5 disks, all full of the very best clipart for DPaint etc. (P)

FONT PACK 1 OR 2 EACH PACK = 5 DISKS £5.25
2 different packs of 5 disks, pack 1 contains: Publisher fonts, various fonts, fonts disk 2, Cosmopolitan fonts, large fonts (loads of great fonts for DPaint etc.) (P)

ANGLIA COLOUR FONTS PACK 1 OR 2 (P) 5 DISKS £5.25
5 disks full of original colour fonts produced here at Anglia. There are 16 colour fonts - not cut and paste! They are produced in the same way as the chisel font supplied with DPaint and the Kara range of commercial fonts! They are typed straight in and work with DPaint and TV Text.

EDUCATION PACK 1 (P) 5 DISKS £5.25
German, Globe, Geotime, Evolution, Clouds, Formula, Airfoil, Gravity Sim, Weather, Wave Maker and more! (This pack is one of our best sellers and is incredible value for money).

ASTRONOMY PACK (P) 4 DISKS £4.20
This superb pack now includes: Star Chart, Amigazer, Total Concepts, Astronomy, Gravity Well, Grav Sim, Orbit, Planet and Fast Facts on the solar system.

PRINTER USER PACK 2 (P) (NEW) 4 DISKS £4.20
A completely new collection of programs to help you get the best out of your printer! Includes: Diskprint V3.51 (Disk labels), MCMaster (Cassette covers), Printfiles, JBSPool, Envprint (Envelopes), New Print (Margins - Headers Footers etc.) and more.

SIMULATIONS PACK (P) 5 DISKS (Not A1200) £5.25
All the PD Simulations in one pack: Metro, King Oil, Nuke, Imperium, Sealance, Truckin, DC10, Conquest, Insiders Club, Air Warrior.

DISK EXPERT PACK (P) 5 DISKS £5.25
If you want to learn more about your Amiga, get this pack! - You'll be a disk expert in no time! Includes Power Packer (Easy file compacter), Sid (Brilliant CU Replacement Tool!), Iconmania (Change any icon in seconds), Fixdisk, Viruschecker V5.3, D-Copy (Copies, Repairs, Formats and more), CU Tutorial (All you need to know) and 909 other utilities!!

"C" PROGRAMMERS PACK (P) 6 DISKS £6.30
A complete "C" language and superb instruction manual provide all you need to learn the "C" language, includes North C (2 disks) and the C Manual (4 disks)

MED V3.21 MUSIC PACK (P) 4 DISKS £4.20
MED is widely recognised as the best music package, PD or otherwise!! This pack contains V3.21, the latest version complete with loads of digital samples, a disk full of MED music scores and some great MED music to load and play! Listen to what your

machine is capable of!

500+ CLASSIC GAMES PACK (P) 5 DISKS £5.25
An incredible collection of superb commercial quality arcade games! Hours of fun for both kids and adults. Includes: Defender, Galaxians, Scramble, Missile Command, Pac-Man, Bi-Planes, Dnpi, Space Invaders, Asteroids, Breakout, Tetris + more!

CARD + BOARD GAMES 2 (P) 4 DISKS £4.20
Another outstanding collection! 38 very good "Thinking" Games! Chess V2, Backgammon, Blackbox, Towers, Pipe, Zerg, Maze, Connect4, Dominoes, Draughts, Othello, Go Moku, Dragon Tiles, Klondike, Canfield, Mastermind, Wordsearch, Hangman, Pontoon and many more.

PUZZLES PACK 3 (P) 3 DISKS £3.15
6 brand new graphical puzzle games, all brilliantly done, guaranteed to keep you playing! Ashido, Flag Catcher, Rothello, Quadri, Paragon, Technoban.

HARD DISK PACK 2 (P) 3 DISKS £3.15
Great collection of the latest hard disk utilities includes HDclick (menu maker), fileminder (directory etc.), a backup (superb), superlock (password protect every drive, mouse and keyboard!), disk optimizer, copier, virus killer and more!

SHOOT 'EM UP PACK (P) 5 DISKS £5.25
The finest blasting games in PD! Includes: Galaga 92, Revenge, Intruder Alert, Blizzard, Tom Cat, Moonbase and Hellzone.

ANGLIA CLIPART PACK (P) (NEW) .5 DISKS £5.25
Brand new FF clipart produced by Anglia! Loads of high quality anti-aliased FF images including cats, dogs, birds, wild animals, people and characters. Use with DPaint or any program that accepts FF graphics.

MATHS REFLEX PACK (P) (NEW) 2 DISKS £2.10
For ages 8 to adult - A superb way to improve basic maths. Includes addition, subtraction, multiplication, division, fractions and algebra. Also includes a fun memory game.

BEGINNERS BUSINESS PACK (P) 4 DISKS £4.20
Designed especially for newcomers to business software, this pack contains a database (Bbase), spreadsheet, accounts package and Wordprocessor (QED). Also included are a 12,500 word spelling checker and a word statistics program!

BEGINNERS BUSINESS MANUAL (P) £2.99
Approx 50 page professionally printed manual containing full instructions for the beginners business pack. Includes a specially written guided tour section that takes you through the major features of each program and ensures that you can use each program with confidence!

SINGLE DISKS AT ONLY £1.05!

BUSINESS
B321 (P) (85%) Amigafox (English Desk Top Publishing)
B322 (P) (95%) 600 Business Letters (Superb! - Ready to use)
B330 (P) (80%) Amicash (Superb new bank account manager)
B332 (P) (90%) U-Edit V3.0A (Latest and greatest word pro)
B333 (P) (86%) Ambase Professional 2 (Now PD! - Super database)
B335 (P) (92%) Forms unlimited (Design invoices etc., quickly)
B339 (P) (I) A-Graph (Produce Bar + Line Graphs easily!)

B327 (P) (I) (86%) Text Engine V3.4 (great looking wordprocessor)
B342 (P) (New!) Wordpower (Great spell checker with crossword and anagram solving tool)

B344 (P) (NEW) The Money Program (Very nice accounts package)
B346 (P) (I) Account Master V2 (Excellent home accounts with full printing!)

UTILITIES
U416 (P) (70%) Cii Tutorial (Learn all about it)
U437 (P) (I) (95%) D-Copy V2 (Now an even better disk copier!)

U478 (P) Typing Tutor (New! Great features)
U495 (97%) Viruschecker V6.19 (P) (The latest - For the plus too!)

U496 (P) (95%) Messysid V2 (Reads and writes PC disks)
U497 (P) (95%) A500+ Utilities (For the A500+ only!)

U4004 (P) (NEW) Pools Predictor (It's back! 1992 season)
U4009 (P) Amiga Tutorial (A beginners manual on disk, superb!)

U4022 (P) Opticomms 2 (Includes ncomm V2)
U4025 (P) (94%) PC-Amiga (Transfer files and much more - superb!)

U4026 (P) Superkillers 2 (All the best virus killers on one disk)
U4027 (P) (NEW) Inscript (The finest video title yet seen - incredible features - very professional!)

U4028 (P) Printer Drivers (Over 100 - Most Star + Citizen models including colour and HP500C)
U4029 (P) Degradar (Turn WB2 into WB1.3 - Lets you load those problem programs!)

GAMES
G6019 (P) A500+ Games (21 Games for the Plus!)

G6027 (P) (I) (91%) Lothian Superb ultima type adventure - great graphics - hordes of monsters! (NEW)
G6035 (P) (NEW) Klaktris (Superb "Columns" game!)

G6036 (P) (I) (NEW) (92%) Total War (Perfect version of The Risk board game)
G6042 (P) (NEW) Super Pacman 92 (Easily commercial standard!)

G6045 (P) (88%) Amos Cricket (The best PD cricket game)
G6046 (P) Amos Fruit Machine II (More features than ever!)

G6047 (P) Dr Mario (The classic console game)
G6048 (P) Act of War (Substantial Arcade Adventure - Like Laser Squad!)

G6049 (P) Neighbours 2 (2 disks) (2.10). Have an adventure in Ramsey Street!

CHILDRENS
C712 (P) Colour Pad (New colouring book for youngsters)
C714 (94%) Storyland II (Brilliant kids game)
C719 (P) (87%) Total Concepts (2 Disks) (Astronomy & Dinosaur Education Pack - Good!)

C720 (P) Colour the alphabet (Great education for early learners 4ys+)
C724 (P) (95%) Doody. (Like Mario Bros and very good -NEW!)

C725 (P) (91%) Mr + Mrs. (Platform adventure for 7yrs+ - it's got everything!)

C726 (P) (83%) GCSE Maths (Great revision disk)
C727 (P) (100%) Top Secret (Reviewed as the best platform game ever!)

C729 (P) (NEW) Counting Fun (For age 4+, Excellent simple arithmetic practice)
C730 (P) Wizzys Quest (Wizard, Damsel + Monsters, great game!)

C731 (P) (NEW) Willy in the Castle (Professional platform game)
C732 (P) (NEW) Fractions (Excellent fractions tutor)



DESKTOP VIDEO PACK 2 (P) (100%) 4 DISKS £4.20
Probably our best pack yet! Provides everything to start you off in video. 5 Movie for Smooth scrolling titles using any font of any size. Showbiz for slideshows with loads of wipes and fades. A-Graph for business videos. Shadow Maker to add shadows and smooth any font. Video Librarian. Video Tools. Video Tests. Loads of fonts and more!

DESKTOP VIDEO PACK 2 INSTRUCTION MANUAL!!! (P) £2.99
A 50 page instruction manual for DTV pack 2. Professionally printed, contains instructions for all the programs in the pack and a section on fonts and how to use them! Also includes a superb guided tutorial that takes you through the major programs step by step, letting you create your own titles as you go! Designed for beginners and experienced users, this manual will make desktop video easy!

FISH DISKS IN STOCK 350-780 ONLY £1.05 EACH!

DEJA VU "1-LATEST" £3.99 EACH!

HIGH QUALITY HARDWARE
8mm High Quality Mouse Pad£2.99
Amiga 500/500+ Dust Cover£3.99
Monitor/TV Dust Cover£4.99
3.5" Disk Drive Cleaning Kit£2.99
2 Piece Printer Stand (Paper under)£5.60

ANGLIA PUBLIC DOMAIN LIBRARY
(Dept AMF), 115 Ranelagh Road, Felixstowe, Suffolk, IP11 7HU

Access VISA CARD ORDERS PHONE 0394 283 494
International orders welcome but please add 30p per disk for post & packing. **CREDIT CARD**

Simply phone your order through or send a cheque/postal order. Please add 60p to cover post and packing.

1000s OF TITLES **THE P.D. WAREHOUSE** 1000s OF BARGAINS

£1.35 A DISK BRITAIN'S BIGGEST COLLECTION OF P.D. SOFTWARE

100s OF TOP GAMES - ARCADE ROLE PLAYING - ADVENTURE-SPORTS-BRAIN ACHES- -SIMULATORS-FAR TOO MANY TO LIST

MOUNTAINS OF MUSIC - SAMPLE EDITORS-POWERFUL MIDI SEQUENCERS-DRUM MACHINES- LOADS OF SAMPLED & MIDI MUSIC DEMOS - COMPOSERS & MORE

GRAPHICS GALORE - LOADS OF PAINT/DRAWING PACKS-ANIMATION-CARTOONS-FONTS- HUGE QUANTITY OF CLIP ART-ETC. ETC.

UNLIMITED EDUCATIONAL - G.C.S.E. REVISION-TYPING & LANGUAGE COURSES-ASTRONOMY- ASTROLOGY-KIDS READING/WRITING/MATHS/SHAPES/COLOURS ETC & LOADS MORE

PILES OF PROGRAMS - UTILITIES-COMMUNICATIONS-DATABASES-ACCOUNTS-PUBLISHING- STOCK CONTROL-COMPILERS-PRINTER DRIVERS-VIRUS KILLERS & LOADS MORE

ALL DISKS VIRUS CHECKED **PHONE NOW FOR FREE MASSIVE CATALOGUE!!** **SAME DAY DESPATCH**

081-290-6140

PRINTED INSTRUCTIONS WITH EVERY PROGRAM.

P.D.-SHAREWARE-LICENSEWARE-BUMPER BARGAIN PACKS

NEW TITLES ARRIVING REGULARLY

175A WIDMORE ROAD, BROMLEY, KENT BR1 3AH

OBLIVION
 CYNOSTIC G0015

GAME

How I miss the long hours down at the seafront. Never mind, I can play something nearly as good at home – this!

Do you miss the long sessions on William's *Defender* and *Stargate* machines? Do you yearn for all that on-screen mayhem and manic button stabbing? If so, or if you're into high-speed shoot-em-ups in general, then check this out. *Oblivion* is a machine-coded shareware game by Mark Sibly from New Zealand. Admittedly, the graphics look a little crude – but they move in a fashion most zippy.

There have been a couple of changes to the original. For a start, the playing area is taller than the visible screen – the starfield background scrolls to accommodate this. A shield button has been added, and the old hyperspace function taken out – all the controls (up, down, fire, thrust, reverse, smart bomb and shield) are mapped on to the keyboard, which is the way this sort of game should be played.

The aliens still kidnap the humanoids. However, when you shoot the kidnapers, the humanoids do not plunge to their doom – instead a parachute opens and they float back to the ground. You can still pick them up for a bigger bonus though.

I like this game loads. The only weakness is that it's a bit too easy when played with a joystick – stick to the keyboard for the proper arcade feel. The shareware contribution you make is left to your discretion. Makes a change from all the 'I demand a fiver' shareware writers.

KICK 1.3
 17 BIT SOFTWARE

UTIL

If you want to see this well naff (but highly compatible) boot screen, get this disk or a new ROM chip.

Are you the lucky owner of a new A1200 or A600? Do you want some more compatibility, that is the ability to run older, and some would say better games? Well then look no further than *Kick 1.3*.

Admittedly it's not quite as convenient as a ROM sharer (plugging in an old 1.3 Kickstart chip and flipping a switch). Instead, you have to boot this disk before you run games from your old and neglected games software collection. It does just the same job as a ROM Sharer and it's a hell of a lot cheaper. Widely available from most PD libraries.

PD Update

Seasons change, but Public Domain software continues to avalanche down on to the desk of **Pat McDonald**.

Here are some of the best of the current crop.

CDPD II
 ALMATHERA SYSTEMS

PDCD

So, you want to bulk buy some PD? Get it on CD then! Admittedly, this disk is not brilliant if all you have is a CDTV (no keyboard or floppy disk drive). However, if you have those (or an A500/A500 Plus with a CD-ROM drive) then it's damn good value for money.

This disk takes over from the original CDPD, which had the Fred Fish PD collection, from disk 1 to 660. With this disk, you get Fish Disks 661 to 760, the first 10 *JAM* disks (*Just Amiga Monthly*) and the *MicroScope* disks from 1-20. Even though there are less disks than the Fred Collection, the actual amount of disk space is the same.

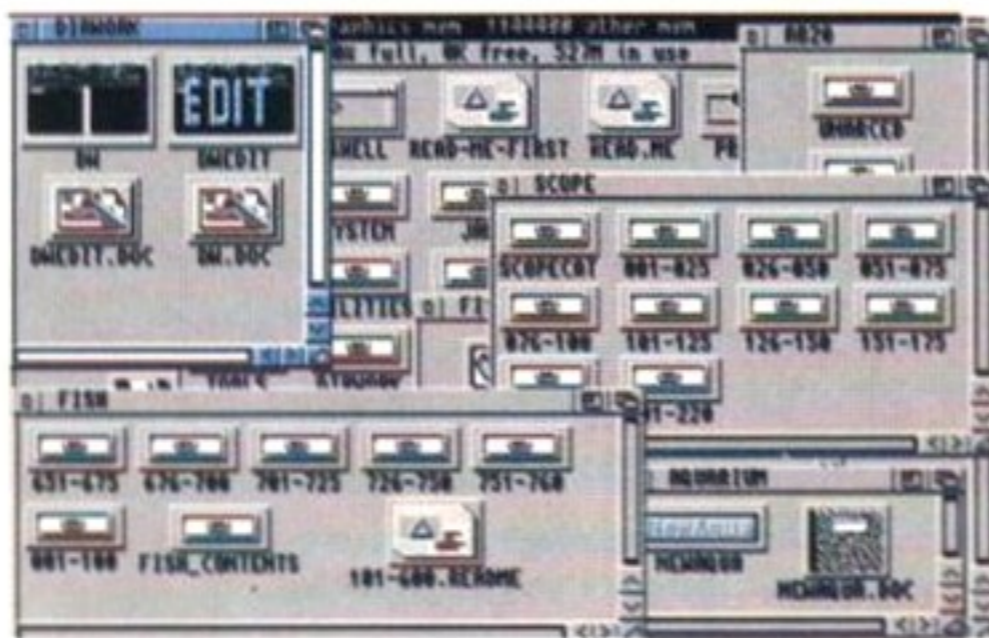

More Public Domain software than anyone really has a need for – but it's a posey Workbench, you have to admit.

Both Workbench 1.3 and 2 have been included too. What this means is that you can boot straight from the CD, rather than booting Workbench from a floppy first (as you had to do with the original CD Fred Fish collection). The frontend includes the *Aquarium* utility, for scanning through the collection and choosing what you want.

It's really the best value for Workbench 2 owners, as Workbench 1.3 can't run about 10 per cent of the software on the CD. Oh yes, also included is the Parnet driver software and details of how to build Parnet – a

simple network using the Amiga's parallel port. If you want to invest in a serious amount of PD, then CD is the way to go.

COOK & STITCH
 GEORGE THOMPSON

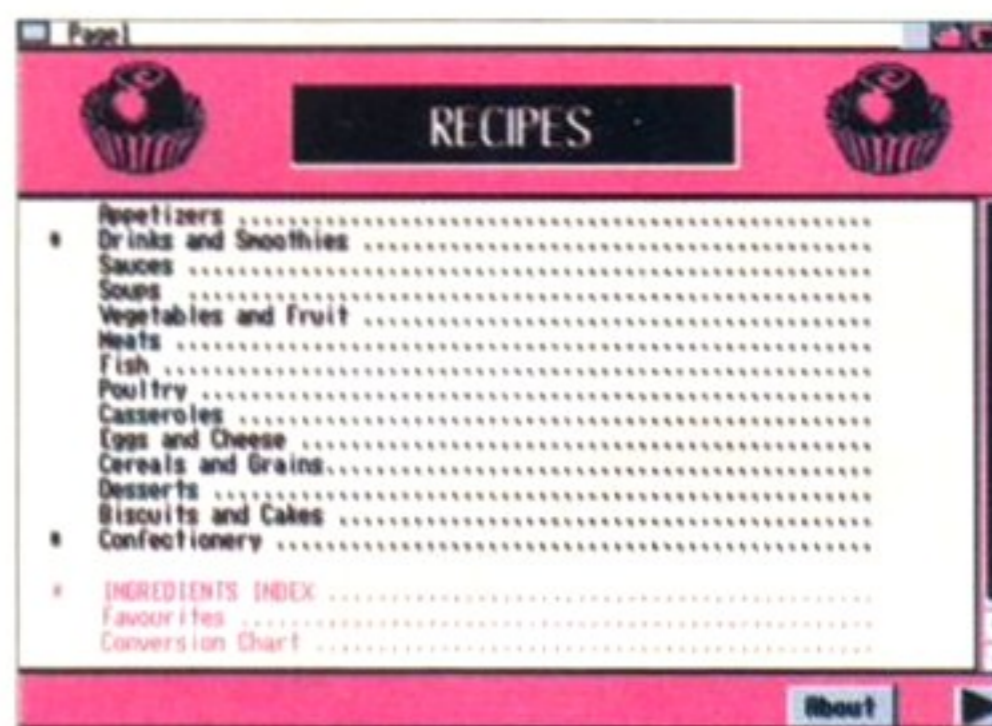
TOOL

HyperCook made with *HyperBook*. If you want an example of an interactive recipe book, get this.

This is one of the Australian Megadisc collection, and very good it is too. There is a program on the disk called *The Stitchery*, by Bradley Schenck, which turns an IFF picture file into an embroidery pattern. Apart from HAM and the new AA chip set graphics modes, all of the other Amiga graphics are supported.

Also on the disk is *Hyper Cook* (a simple recipe database created with Gold Disk's *Hyper Book* program) by Leigh Murray; *HomeBrewer*, a guide to making your own alcohol by Beau Rice; and the *BonAppetit* and *DietAid* programs, which have appeared before on Fish disks. So if you're a poor student (or a poor anyone!) looking for cheap inspiration to improve your quality of life, check out this disk.

Continued on Page 182

II 2 STROKE PETROL ENGINE
EDUC

ROBERTA SMITH IIS004

Inside Info, that's basically what II stands for. This is a short but very well drawn animation, showing the different cycles of (you guessed it) a two stroke petrol engine.

The animation doesn't jerk through the cycles – it's a nice smooth continuous motion that is very easy on the eye. Congratulations to Michael Warren-Leighton for an educational anim that looks brilliant.



I regret magazine technology can't show you this animated – get the real disk and find out for yourself.



Jimi Hendrix, live and unleashed on *Stolen Data 10*. Wish I'd come across this disk mag before.

STOLEN DATA 10
CYNOSITC

MAG

Anarchy Worldwide have been putting out this two disk magazine for quite a while, but I must admit I haven't seen it before. Boy, have I been missing out on something rather good.

The gallery section alone is worth getting the disks for – but if that's all there was to it, this disk would have ended up in the Demos section rather than Update. Not forgetting an equally excellent music content, it has to be said.

Stolen Data is actually put together in the UK, by Judge Drokk and Kreator of Anarchy. Many, many different people contribute to it – a lot of the artwork is gathered together in France and Germany too, but it actually originates from all around the world. LSD

Grapevine tends to be a bit UK heavy – that's fine by me because that's where I live, but not everyone appreciates the fact.

The frontend really goes to town – pages whiz on and off the screen at a high rate of notes, and each one is really easy on the eye. It's really swish.

Subjects covered are the usual adolescent (no offence intended) subjects – metal CDs, women, more women, coding, the Amiga in general, Lamers (I hate that word), a rather in-depth piece on the M16 assault rifle (no it doesn't tell you how to make one), the future of Hi Tech, USA viewpoint and so on.

Even if you don't like the content, even if you think these guys are wasting their time (and I don't) you'll have to admit the layout, presentation and general funkiness is the way that magazines will be tomorrow. Shame you need an Amiga to read it – but this is the future of magazine publishing. The good news is, you can taste it now.

AMIGA FORMAT

TELL THE TIME
DEJA VU L122

EDUC

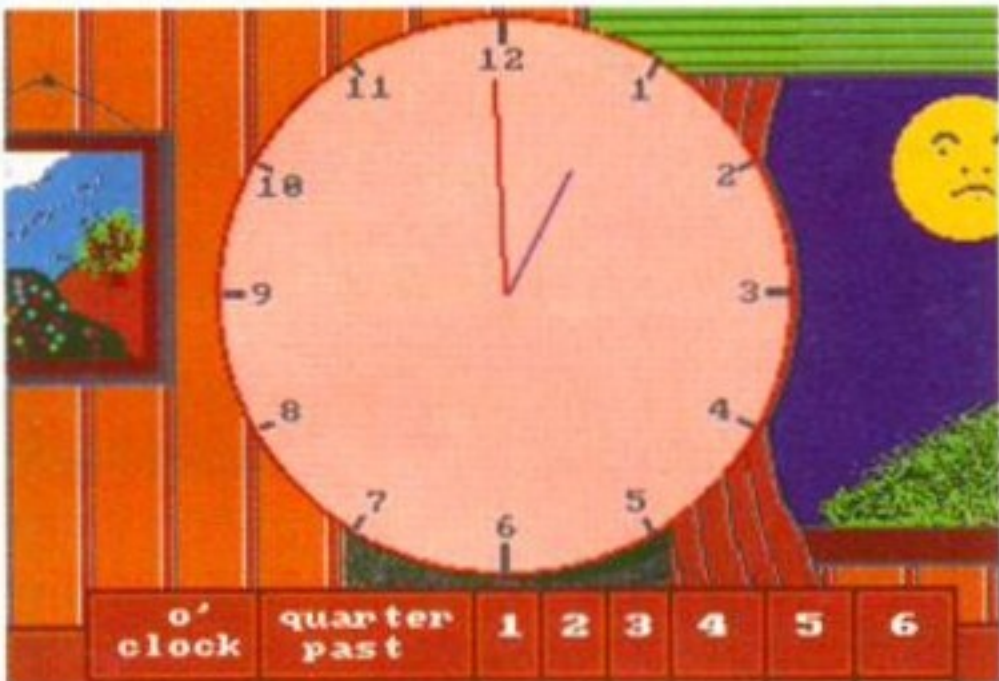

Although this educational game doesn't look brilliant, it does offer a fair range of different tests about time.

MJ Austin must have spent a long time programming this educational feast. It consists of five exercises, which gradually get harder. The graphics aren't special but they do animate. It's almost totally mouse controlled (except where you type in your name and the last level).

The five levels are – basic tell the time (easy and tricky levels), train times (gets a bit boring), shoot the aliens (quite fast, 3D shoot-em-up, but you have to answer the questions correctly before the game will let you blast) and Clock Catcher, a simple platform game. You do need a joystick for the last game, unfortunately. All things considered it's a very good set which children should find better than traditional lessons.

YIPPEE!
DEJA VU L119

EDUC



Leaping, ducking and running? A rhinoceros? Oh good, you can see it too. I thought I was hallucinating.

Here's another PD education program. Are you having problems getting your children to study a dictionary? Worried about their spelling? Get them this. *Yippee!* masquerades as a fairly standard platform game, with a rhinoceros as the main character. This guy (plainly a guy – he's wearing shorts) can duck, leap, run and climb as only a rhino can.

You see, the animation on this game is so good that it takes a while to suss what the objective is. Dotted around the screen are various letters – you have to pick

up the right letters to form words. The order doesn't matter, and you can't pick up the wrong ones.

Great concept, good music, excellent graphics – I've only got one complaint with the author, Nik Lever. Why on Earth didn't you compile it? It would have been much smoother (it does tend to jerk a lot). Then again, maybe putting out the compiled version would have bloodied some noses in the commercial software sector.

TOP 10 DEMOS OF THE MONTH

Every month we print a chart of the Top 10 demos from a popular PD library. This month it's the turn of...

NBS

1. Compugraphic Type Fonts Volume III
2. Adobe Illustrator Clip Art Volume II
3. PageStream – The Demo
4. ProDraw Clipart
5. Kingfisher – Fred Fish Database
6. K O The Virus Version 5.3
7. PageStream Update Disk#1
8. Adobe Illustrator Clip Art Volume I
9. PDQ 25 – PD from Jumpdisk
10. Alphabet Soup (Educational)

WHERE TO GET THE DISKS IN THIS ISSUE

17 Bit Software: 1st Floor Offices,
2/8 Market Street, Wakefield, West Yorkshire
WF1 1DH. 0924 366982

Almathera Systems: Challenge House,
618 Mitcham Road, Croydon CR9 3AU

Cynostic PD: 85 Wyken Croft, Coventry, CV2 3AD,
0203 613817

Deja Vu: 7 Hollinbrook, Beech Hill, Wigan,
WN6 7SG, 0942 495261

George Thompson Services: Bridgegate Centre,
Martinfield, Welwyn Garden City, Herts AL7 1JG,
0707 391389

NBS: 1 Chain Lane, Newport, Isle of Wight, PO30
5QA, 0983 529594

Roberta Smith DTP: 190 Falloden Way, Hampstead
Garden Suburb, London NW11 6JE, 081 45516261

VMORPH 2B
NBS 13/U15

TOOL



If you want to blend and bend black-and-white images, this program is for you.

The in-thing in films and videos at the moment is *Terminator 2*-style visual effects. It's called morphing: a transition, from one image to another, which works out the stage in the middle. This PD program does just that – and it can warp between images too.

VMorph (*Vidi Morph* – using a morphing program without a digitiser is pointless) has been written in AMOS, by Lee Wilkie. This disk version is only a beta test, and can only handle 16-colour grey-scale low-resolution images, but further improvements are planned.

The author has been forced to circulate the original, uncompiled AMOS code, as it won't (for some reason) compile. He would welcome all feedback on the program – all I've got to say is well done!



**Premier Retailers of
Software & Hardware
for Education, Business,
Creativity & Leisure.**

**Commodore Amiga,
CBM 486 Powerline Series,
Philips CDI, Sega & Nintendo**

**Colour Monitors, Printers, Joysticks,
Memory, Accelerators, Genlocks,
Floppy Drives, Hard Drives, Books,
Business & Educational Software,
& more games than you could ever play!**

Visit one of our fine stores at :-

**30 High Street, Kingston Upon Thames,
Surrey KT1 1HL 081 546 5941**

**Waterglade Centre, Ealing Broadway,
London W5 2ND 081 840 4114**

LOWEST PRICED TOP QUALITY RIBBONS

	1 off	2+	5+		1 off	2+	5+
Amstrad DMP 2000/3000	2.80	2.65	2.45	Star LC10/20 Black	2.29	2.14	1.94
Amstrad DMP 4000	3.66	3.51	3.31	Star LC10/20 Colour	6.00	5.85	5.65
Citizen 120D/LSP10/Swift 24/9	2.85	2.70	2.50	Star LC200 Black	3.00	2.85	2.65
Citizen Swift 24 Colour	12.81	12.66	12.46	Star LC200 Colour	9.78	9.63	9.43
Commodore MPS 1220/1230	4.50	4.35	4.15	Star LC24-10/200 Black	2.86	2.71	2.51
Epson LQ400/500/800/850	3.45	3.30	3.10	Star LC24-10/200 Colour	9.63	9.48	9.28
Epson FX/MX/RX80/FX/LX800	2.90	2.75	2.55	Canon BJ-10 Inkjet Cartridge	Original 17.54 each		
Epson FX/MX/RX100/FX/MX1000	3.36	3.21	3.01	HP Deskjet Cart. (Double Cap)	Original 21.79 each		
Epson LX80/86/90	2.12	1.97	1.77				
NEC Pinwriter P2200	3.03	2.88	2.68				
Panasonic KXP1123/1124/1140	3.46	3.31	3.11	Canon BJ-10 Refill (Twin Pack)	11.00	10.60	9.95
Panasonic KXP1080/1180/90/1592	2.89	2.74	2.54	HP Deskjet Refill (Twin Pack)	11.00	10.60	9.95

Ring for ribbons, inkjet cartridges and inkjet refills not listed

Ring us and we will beat all other prices

0543 250377

Ring us or send cheques to:

0543 250377



Owl Associates, Dept 41, Owl House,
5 The Brambles, Lichfield, Staffs WS14 9SE

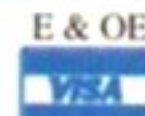

ALL PRICES INCLUDE VAT & DELIVERY

MATRIX SOFTWARE CLUB

As a Matrix member you can choose from our extensive lists of the latest and the popular software with our absolute guarantee to buy them back. AND you don't have to pay until you've decided.

**BUY YOUR
SOFTWARE
FROM US.**

**WE'LL BUY
IT BACK!**

• TOP NAME

GAMES, BUSINESS AND UTILITY SOFTWARE

Over 20% off retail prices

• NO COMMITMENT TO BUY

• SUPER FAST SERVICE • ESTABLISHED 1981

• OVER 2,500 MEMBERS

To find out about the unique Matrix money saving scheme call our 24 hour hotline 0920 484479



Or send a large s.a.e. stating your machine (IBM/PC 3.5", Amiga, Atari ST) to:

Matrix Computing Services, Dept AMF1, 2 Frenchs Yard,
Amwell End, Ware, Hertfordshire SG12 9HP

ARTWORKS CLIP ART

Each disk contains between 115 and 270 original, high quality, images for use with Amiga Art and DTP programs - Deluxe Paint, Pagesetter, Pro Page, Pagestream, Wordworth, Penpal etc.

1. Pets
2. Castles, cottages and churches
3. Trees
4. Signs & symbols
5. Wild animals
6. Prehistoric life
7. Signs & symbols II
8. Weddings & family occasions

£6.99 each - Buy 3 or more for only £6 each - Over 1400 images for only £48

Inclusive of 1st class P&P.



AMIGA COMPUTING - "Best Buy"
CU AMIGA awarded ★★★★★ - AMIGA FORMAT 85 %
Please make cheques/PO's payable to ARTWORKS
(Dept AMF) 1, Pond View, Wootton, Ulceby, S.Humberside. DN39 6SF ☎ 0469 588138

AMIGA SPARES

Amiga Power Supply (exchange price)	£19.99
Amiga Power Supply (non-exchange price)	£29.99
A520 Modulator (exchange price)	£19.99
Chinon 3 1/2" Internal Drive	£39.99
A500 Keyboard	£49.99
Amiga Mouse	£6.99
Other spares	P.O.A.



Cheques/PO to:
Omnidale Supplies, Dept C,
23 Curzon Street,
Derby DE1 2ES.
Tel: (0332) 291219



DIGITALLY MASTERED SAMPLES

127 SOUND SAMPLE LIBRARIES



Each disk is compiled from a studio quality master and is sampled on the Amiga at twice the sample rate of P.D. sample disks. They are compatible with all P.D. and commercial tracker and sequencer programs. N.B. no. of samples in brackets

001 samples	Talking drums, Marimbas, chants etc (53)	014 samples	Slap, picked, fretless, FX etc (44)
002 samples	Sitar, Bansuri, Chants etc (19)	015 samples	Oberheim, Roland, Korg etc (22)
003 samples	Tabla, Bayas, Rhythm Loops etc (35)	016 samples	Yamaha DX, Roland, Korg etc (28)
004 samples	Udi, Saz, Bendir, Rhythm Loops etc (37)	017 samples	Sections, Saxes, Trumpets etc (24)
005 samples	Tibetan Bells, Yangqin, Koto etc (31)	018 samples	Analog, Digital & L.A. etc (18)
006 samples	Balalaika, Choirs, Bodhran etc (34)	019 samples	Octave Splits, with strings, FX (16)
007 samples	Dijleridu, Chants, Silt Drum etc (23)	020 samples	Cello, Orch, Hits, Sections etc (21)
008 samples	Kena, Berimbau, Pan Pipes etc (30)	021 samples	Analog & Digital (19)
009 samples	Power Toms, Snare & Bass, Scratch & Rap (88)	022 samples	Mixed Choirs, with Bells & Synth (16)
010 samples	Bass & Snare, Hi-Hats, Cymbal & Toms (63)	023 samples	Church & Electric (17)
011 samples	TR-808 CR-78, Loops etc (30)	024 samples	Real & Synth, with Choir & Strings (20)
012 samples	Timbales, Congas, Cabaças, Cowbells etc (107)	025 samples	Action Sounds, Explosions, Gunshots etc (30)
013 samples	Acoustic, Electric & Distorted etc (41)		

Each disk is priced at £2.50, any 10 for £19.95, the Complete Collection for £49.95. In addition, Sampler owners can use our Digitally Mastered Chrome, Metal, or DAT sample Cassettes which contain most of the above samples: COO1 WORLD MUSIC COLLECTION (175)

COO2 PERCUSSION COLLECTION (228)

P&P £1 (any order) Cheques & P.O.s to:

COO3 GUITARS AND BASSES (161)

Each Chrome £9.95, Metal £11.95, DAT £16.95

The Three Collection Package is priced at:

£21.95 (Chrome) £25.95 (Metal), £38.95 (DAT)

W.L.A. MUSIC (Dept AP)
TRENTHAM PARK, THE MOUNT, PAR
CORNWALL, PL33 3DA
Tel: 07794 81380

SELECTAFONT COMPANY

UNIQUE 24HR
CUSTOMER
HELP LINE

Over 850 Scaleable Fonts available for the Amiga in both Compugraphic Style and Adobe Types. Each Disk ordered will be made up individually to your requirements.

UNIQUE
PICnMIX
SERVICE

WEEDIE
SHANGHAI
STARBURST
SHRAPNEL
UltraBlack

Fonts are also available on "ready made" Disks at 20% Discount.

Black Forest
IGLOO LASER
Fremont
NERVOUS

PICnMIX
CG Fonts 30p each
Adobe Fonts 25p each

EVCC
Miami
ORBIS

Please send a large S.A.E. with 36p Postage for a Print-Out of all Fonts. Also state which Programs you will be using. them in.

EXPORT
NOV-DOC
Fountain

ProPage/Pro-Draw
Pagestream/PPal
Final Word/WWorth
GD Office/ProCalc

(DEPT AF), 84 Thorpe Road,
Hawkwell,
Nr Hockley, Essex. SS5 4JT

WB2.04/DPaint 4.1
TV-Text Pro
Scala/ProWrite
Pagesetter3 etc

AMIGA SHOPPER

PUTS YOU STRAIGHT

If you're serious about your Amiga, just look at all the hard facts we'll give you...

FREE COVER DISK



A cover disk with a complete assembler development system, source code and loads of utilities

VIDEO

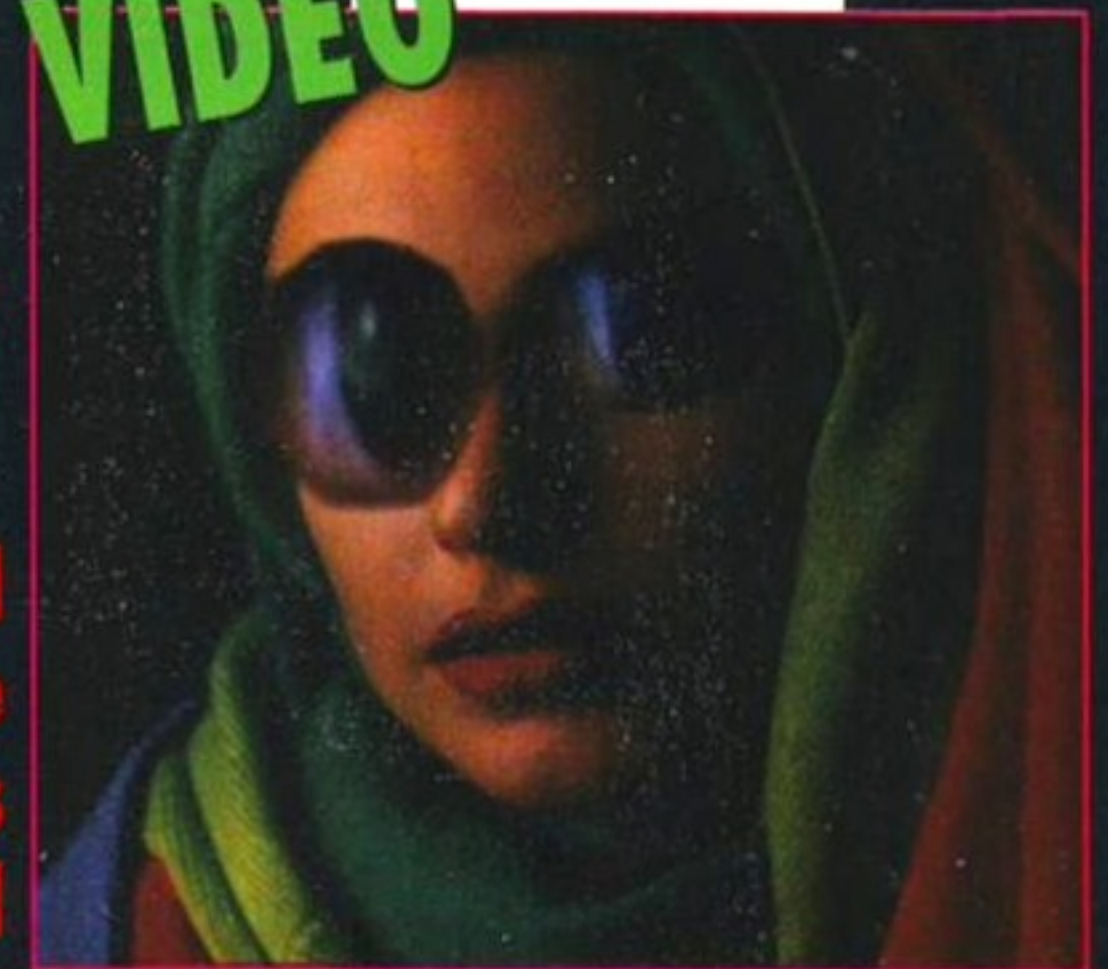

A review of Morph Plus and CineMorph - two of the most exciting video effects packages around

PUBLIC DOMAIN

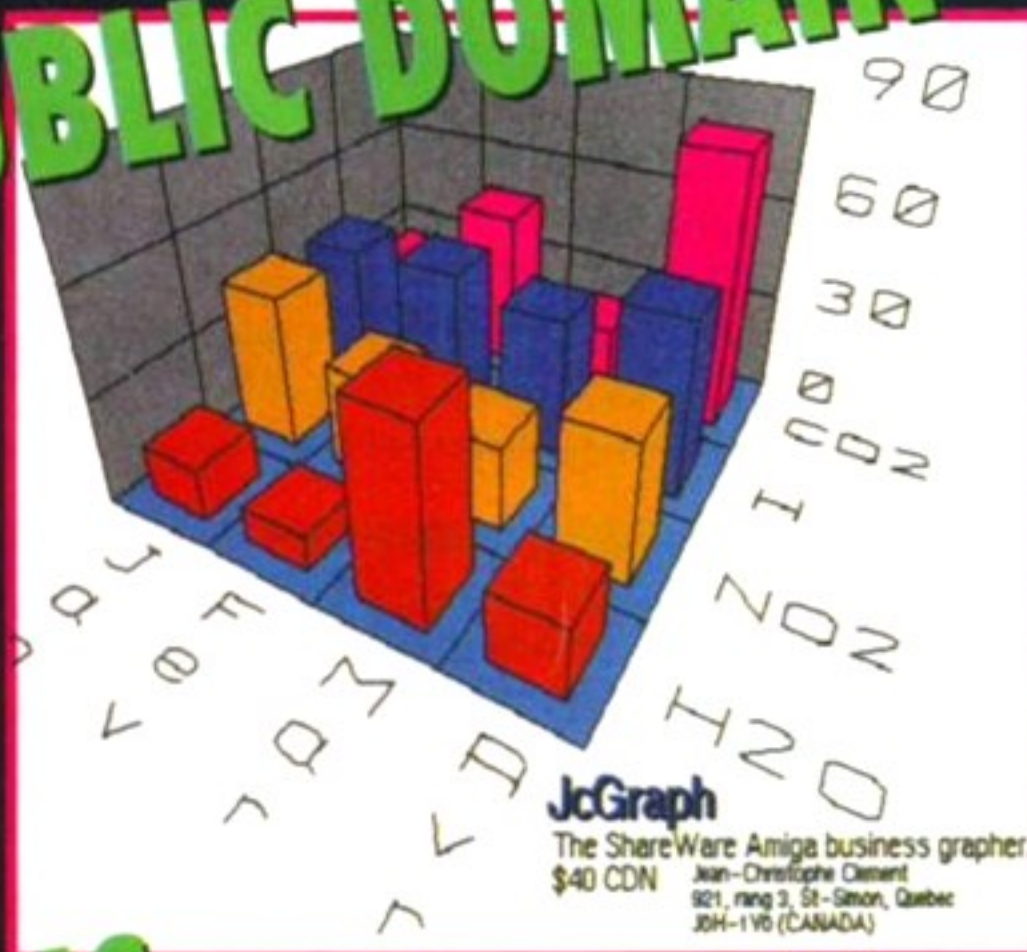

A round-up of the very latest no-cost and low-cost software from the famous Fred Fish collection

DTP



An in-depth, no-holds-barred examination of Power Computing's low-cost colour hand scanner

PLUS

AMIGA ANSWERS

Every month our panel of experts, from all fields of serious Amiga use, answer your technical queries. With a computer as powerful and complex as the Amiga, you're bound to run into problems from time to time - no other magazine devotes as much space as *Amiga Shopper* does to solving them PLUS every month we have regular columns dealing with Hardware Repairs, C, ARexx and AMOS programming, Music, Chaos, Education, AmigaDOS and much more

All the advice you'll need

EXPERT ADVICE AND TIPS FOR EVERY AMIGA ENTHUSIAST

AMIGA SHOPPER

From the makers of **AMIGA FORMAT**

ISSUE 23 • MARCH 1993 • £2.25
YOUR DEFINITIVE AMIGA GUIDE

WIN! MORPH PLUS

Hard hearted

INSIDE

- **SELF ASSEMBLY!**
Get started in assembly language PLUS complete listing and assembler on disk
Assembler: page 24
- **DIY HARDWARE REPAIRS**
Amiga not working? We show you how to fix the most common faults yourself
DIY Repairs: page 56

SPECIAL DISK ISSUE
Seven utilities, an assembler and linker package and all the source code in the mag

What! Your cover disk has disappeared down a black hole? Better ask your newsagent for another

Fit an internal hard drive to your A600 or A1200 - step-by-step instructions start on p11

AMIGA ANSWERS
Let our experts solve your Amiga problems. Whether your hassle is with hardware or software, turn to page 33 for the answers

Future PUBLISHING
Your guarantee of value

Packed with facts

ONLY £2.25

**COMMODORE
1084S STEREO
MONITOR**
Including FREE Lead
ONLY £199.00

**PHILIPS 8833 MK II
STEREO MONITOR**
Including FREE Lead
ONLY £229.00

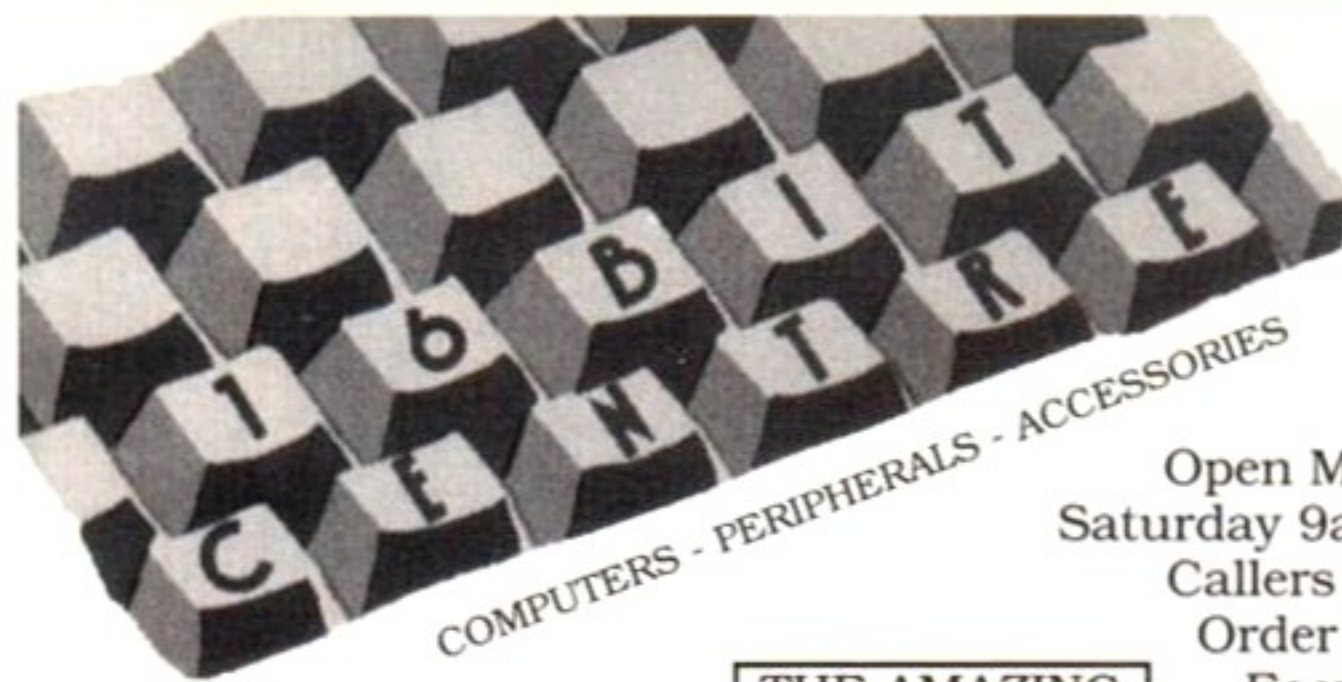

COMPUTERS - PERIPHERALS - ACCESSORIES

**KCS POWERBOARD
PC EMULATOR
FOR AMIGA A500**
ONLY £159.00

**GOLDSTAR
MULTIMODE HIRES
MONITOR WILL
ACCEPT AMIGA AND
VGA INPUTS £249.00**

Open Monday to
Saturday 9am - 6pm
Callers and Mail
Order Welcome
Easy Parking

**THE AMAZING
AMIGA 1200**
Only £369.00

HARD DRIVES

GVP SERIES II 1500/2000 80Mb Quantum Space for 8Mb RAM £319.00	GVP SERIES II 1500/2000 120Mb Maxtor Space for 8Mb RAM £379.00	GVP SERIES II 1500/2000 120Mb Quantum Space for 8Mb RAM £405.00	GVP SERIES II A500 80Mb Quantum Space for 8Mb RAM £369.00	GVP SERIES II A500 120Mb Maxtor Space for 8Mb RAM £405.00	GVP SERIES II A500 120Mb Quantum Space for 8Mb RAM £425.00
---	---	--	--	--	---

AMIGA A600 FUN PACK

Amiga A600, Mouse, Modulator, Manuals, Workbench, Joystick, Disk Box, 10 Disks, Dust Cover, Dpaint 3, 1Mb RAM, PLUS 11 GAMES, Honda RVF, Datastorm, Grand Monster Slam, Dungeon Quest, Powerplay, E-Motion, Kid Gloves, Soccer, Shuffle Puck Cafe, Tower of Babel, Kick Off 2

ONLY £329.00 inc VAT

**COMMODORE
386 x 20
Bridgeboard**
£399.00

Amiga A600
Amiga A600 Wild, Weird, Wicked Pack ... £335
Amiga A600 Cartoon Classic Pack £299
Amiga A600 Epic Pack £479
Amiga A600 Standard Pack £279

SOFTWARE

FINAL COPY 2 £64.99	AMOS PROFESSIONAL £45.00
AMOS + EXTRAS £32.00	QUARTERBACK V5 £39.00
BROADCAST TITLER II £139.00	PRO-WRITE V3.2 £69.00
HOT LINKS £68.00	IMAGEMASTER £119.00
KIND WORDS V3 £39.00	PHOTON PAINT 2 £25.00
LATTICE C V6 £199.00	FINAL COPY 1 £39.00
PAGESETTER V3 £52.00	DESIGN WORKS £59.00
PAGESTREAM V2.2 £125.00	DOS 2 DOS £28.00
PAGESTREAM FONTS £49.00	O/BACK TOOLS £42.00
X CAD 3000 £239.00	WORDWORTH 2 £72.00
CROSS DOS V5 £39.00	SUPERJAM £69.00
SCENERY ANIMATOR £53.00	REAL 3D BEGINNERS £99.00
ADORAGE Effects generator £68.00	
PEN PAL Excellent easy to use word processor £53.00	
IMAGEMASTER 24 Bit Image Processing, includes effects £119.00	
ART DEPARTMENT PROFESSIONAL £119.00	
DIRECTORY OPUS £29.95	
DIGI-VIEW MEDIA STATION £39.00	
BARS + PIPES PROFESSIONAL £179.00	
MORPH PLUS £149.00	
MIRACLE Piano tutor (Hardware/Software) £245.00	
IBM EMULATOR Emulates a PC on the Amiga £39.00	
VISIONARY Adventure creation language £53.00	
MINI OFFICE Integrated package £39.00	
REAL 3D TURBO/PROFESSIONAL £199.00	
PROFESSIONAL PAGE V2.1 with tutorial video £115.00	
PROFESSIONAL PAGE V3.0 New Version £129.00	

HARDWARE

COMMODORE 386 Bridgeboard For 1500/2000 £399.00
ROM V2.04 AND ECS DENISE each £29.00
A570 CD ROM for A500 £289.00
MBX 4Mb 32 bit ram with 68881 co-pro for A1200 £299.00
PCMCIA Card 2Mb for A600 or A1200 (16 bit) £129.00
PCMCIA Card 4Mb for A600 or A1200 (16 bit) £189.00
GVP PC EMULATOR (for GVP A500 hard drives) 16Mhz £195.00
A530 40 MHz Accelerator with 120 Mb hard drive with 1 Mb ram £749.00
DCTV 24 Bit Graphics Board £399.00
GOLDEN GATE 386/25 Bridgeboard for 1500/2000/3000 £425.00
TV TUNER for Philips and Commodore monitors £69.00

PRINTERS

STAR LC24/100 Mono.....24 pin inc free lead £195.00
STAR LC100 9 pin colour inc. free lead £175.00
STAR LC20 9 pin mono inc. free lead £132.00
CITIZEN PROJECT Inkjet mono printer inc. free lead £359.00
HP DESKJET 550 COLOUR inkjet inc free lead £569.00
CITIZEN SWIFT 9 COLOUR 9 pin colour printer inc free lead £175.00
CANON BJ10 EX bubble jet printer inc free lead £219.00
STARJET SJ48 bubble jet printer inc free lead £225.00
HP DESKJET 500 inkjet inc free lead £349.00
HP DESKJET 500 COLOUR inkjet inc free lead £479.00
CITIZEN 200 COLOUR 24 pin printer inc free lead £239.00
CITIZEN 240E COLOUR. 24 pin printer inc. free lead £275.00

MEMORY

SUPRA RX500 8Mb RAM BOARD FOR A500/500+	
With 1Mb £92.00	With 2Mb £117.00
With 4Mb £185.00	With 8Mb £285.00
A500 512K With Clock £29.00	
A500+ 1Mb £32.00	A600 1Mb £47.00
ROM 1.3/2.0 Sharer With Switch (Rom 1.3 £22.00) £12.00	
ROM 1.3/V 2.0 Sharer by Keyboard reset (Rom 1.3 £22.00) £22.00	

MODEMS & FAX

Supra 14400 Fax Modem v32 bis inc. comms software £315.00
Tornado 9600 Fax/Modem (Throughput 38000) £399.00
Supra 9600 v32 Fax/Modem inc. comms software £239.00
Supra 2400 Plus Fax/Modem £149.00
Supra FAX MODEM SOFTWARE £29.00
Supra 2400 Plus Internal Modem for A1500/B2000 £99.00
Tornado 14400 Fax Modem (Speeds up to 57000) £499.00

AMIGA A1500

The A1500 inc. Philips or CBM 1084s or 5 monitor, Twin drives, Dpaint 3, The Works Platinum, Home Accounts, 3 Games + Joystick
ONLY £739.00

AMIGA A500 part exchange available - please phone

ACCELERATORS

Microbotics Accelerator VXL-30, 25MHz £222.00
Microbotics Accelerator VXL-30, 40MHz £351.00
Speed Merchant Doubles Amiga Speed £129.00
GVP 68030 25MHZ WITH 1 Mb RAM £545.00
GVP 68030 40MHZ WITH 4 Mb RAM £779.00
GVP 68030 50MHZ WITH 4 Mb RAM £1090.00

HOW TO ORDER:
Either call our number below with your credit card details, or send cheque/PO or credit card details to our address. Cheques made payable to
THE 16 BIT CENTRE
Prices subject to change without notification.

All prices include VAT and Courier Service

16 BIT CENTRE

**Units 15-17,
Lancashire Fittings Science Village
Claro Road, Harrogate HG1 4AF**

Tel (0423) 531822/526322

**EXTENDED WARRANTY
AND MAINTENANCE
CONTRACTS AVAILABLE
ON ALL ITEMS. PLEASE
CALL FOR FURTHER
DETAILS.**



FLICKER YE NOT

FROM: RICHARD B ARDEN, SHEFFIELD
I have an A1200 plugged into a Philips CM8833 monitor. I've been slowly flicking my way through the manual and have noticed that various monitors can be attached, for example 15KHz, VGA, SVGA, multisyncs and multiscans. Can you give me a simple run down on which does what, and which one is best to go for?

The 15 KHz monitors are very similar to domestic television sets, except they cannot receive TV pictures. Although this means they are limited to about 256 lines on a UK PAL system (less on an American NTSC system) it does mean that they are very good for normal video usage – an important consideration if you want to get into video. However, interlaced graphics (double vertical resolution) will flicker on a 15KHz monitor.



There's a multitude of choices when it comes to deciding which monitor best suits you and your Amiga.

VGA monitors are very closely based on American NTSC TV sets, which means you can miss the bottom or top of your screen when used on an Amiga, so avoid them. SVGA sets work on twice the vertical and horizontal resolutions of VGA, so they seem to be ideal. However, both VGA and SVGA work at 31KHz only – which means they cannot display normal non-interlaced graphics like a 15KHz monitor.

A multisync can usually work at either scan rate, and most multisyncs will automatically lock on to the incoming signal. So multisyncs are really your best option – needless to say, they are also the most expensive. Multiscan monitors work slightly differently, in that they buffer the video signal and display it at twice the normal rate (100 frames a second rather than 50). So multiscans can be a cheap alternative, but most of them don't take separate red, green and blue, or even composite video inputs.

So get a multisync if you need a completely stable display. If you can get one, a second-hand Commodore 1950 is your best buy. The 1960 is not up to the same quality. I use a Kaga Taxan 880 (no longer in production, but a damn good monitor).

However, the story doesn't quite end there. The HAM8 display mode of an A1200 provides enough colour resolution so that interlace graphics produce little noticeable flicker anyway. TV pictures are interlaced and they flicker, but because of the colour resolution you don't normally notice.

Therefore, if you want to do video work, stick to your Philips. If you want to do DTP-style, high-resolution, flicker-free graphics (as well as play games) go for a multisync. If you can't afford a multisync and you don't want to play games too, go for an SVGA.

Workbench

Got a tech spec you can't get your head around, or just not sure what is the best buy? **Pat McDonald** has all the answers...

FOR EFFECTIVE FILMS

FROM: EE FILMCLUB, BELGIUM

We are a group of creative young people who have been into making videos for four years. One of us has an A500 with an A590 hard drive and a KCS PC emulator, which we use for our titles. It's not as easy to choose good colours as people make out!

We want to go a bit further and use the Amiga more. We want to edit tapes, do some special effects, and use it for a bit of music too. So I guess we need a digitiser and a genlock. We need equipment that works with both VHS and Super VHS (S-VHS) and some extra software.

All the video equipment we use is Panasonic. Maybe an A1200 would be a good idea. What do you think? Obviously everything must be compatible with that machine – we have about £2,000 to spend before we start shooting a movie in France. So on to the questions:

1) Does the Genlock + from Roctec work with S-VHS and the A1200?

With S-VHS, no. With the A1200, yes (but get a separate power supply for the genlock). However, the Genlock + isn't very good in terms of the signal quality it gives.

2) Does *Morph Plus* run on the A1200? How about the A500?

Morph Plus will run on either machine with quite a bit of extra memory (and you will need to upgrade the chip RAM of the A500 to at least 1Mb). To get the best results you should have at least 4Mb of memory when you are using *Morph Plus*.

3) Can you suggest some software for creating special effects?

DeluxePaint IV – if you do get an A1200, wait for *DeluxePaint IV AGA*. There is no better program (see the review of it on Page 132). Oh, and you will also need a good operator – try advertising for good local *DPaint* artists. Sorry, ours are booked.

4) We do all the editing by hand – is there a good and cheap system for controlling the videos with the computer? We're not sure whether our equipment uses the Lanc controller standard.

Syntronix Systems do an Amiga-based video edit controller, and many other bits and pieces of video kit too. One of their more useful boxes is an S-VHS to RGB converter, for viewing S-VHS movies on a standard 15KHz monitor. You can contact them on 0332 298422. Panasonic equipment generally doesn't use Lanc – instead, it has a special five pin connector called, funnily enough, the Panasonic five pin.

If you want to do planned edits, then an edit deck which can store the cuts will probably be much cheaper – the Videonics 'Thumbs Up' TU-1 is especially good, and can handle S-VHS and VHS equipment. It costs £200. For about £180, the Panasonic EC-1EWE is much simpler to operate, but



Videonics' 'Thumbs Up' TU-1 gets the 'thumbs-up' for its storing capabilities of planned edits. It's great!

you can only do one cut at a time.

5) What is a single frame controller and do we need one?

A single frame controller will enable you to make per-

Continued overleaf

B FOR BART BUG

FROM: EDWARD LUI, CLEVELAND

In *Amiga Format* issue 43, you said that the Bart demo had a bug in the Great Wall of China section – if you hit too many obstacles then the game stops. I discovered that if this happens to you and you hit the B key, then you can continue with the game. If you want to, you can hold on to the fire-button to fly through the air and over all the obstacles!

Thanks mate. I wonder if it's B for Bug?

It's a real B..... when Bart can't leap over the Great Wall of China, but you needn't get bugged any more.

AMIGA Arcade Issue 43

THE SIMPSONS... BART'S WORLD

Bart's back! And this time he's having more fun than ever in this amazing playable demo from Accolade!

Ever-popular cartoon star introduces a great way to learn in this enchanting demo from Jumping Bean

NODDY'S PLAYTIME

1Mb needed • All Amigas • 1Mb needed

BASIC ERROR

FROM: BRIAN TUCKER, HAILSHAM

Having just purchased a GVP 40Mb hard drive with 2Mb of fast RAM for my A500, the problems have started. Hopefully you can help – please?

1) I have a disk named HHINFO with information on (Basic listings mostly). I wanted to put it on to my hard drive. I copied a drawer on to the hard disk partition called Work, renamed it to HHINFO then opened Shell and typed:

```
Copy HHINFO all to Work:HHINFO
```

That didn't work, so I tried:

```
Copy DF0: all to Work:HHINFO
```

In both cases when I try to open either of the two directories contained on the disk I get AmigaBasic error 205. I spoke with a local computer outfit who suggested I try to assign the drawer, so I typed this into Shell:

```
Assign HHINFO: Work:HHINFO
```

When I tried it, the machine told me that it couldn't

find Work:HHINFO. This is happening with all my data disks – what am I doing wrong?

Nothing obvious, but it always pays to make sure that you have an actual directory – just clicking and dragging icons is not always good enough, and the Assign command couldn't find the directory. So first, type this:

```
Makedir Work:HHINFO
```

Then if you don't get a message saying that the directory already exists, your former efforts should work. I prefer to use more understandable syntax – it helps if someone is looking over your shoulder, like this:

```
Copy all from DF0: to Work:HHINFO
```

2) Having successfully installed some games on to my hard drive, *Eye of the Beholder 2* will not run. The strange thing is that it installs and runs fine on an A1200! Any help would be appreciated.

It's got to be because there isn't enough chip RAM available to load the game – I had exactly the same problem. First, make sure that all your hard disk partitions are mapped into F for Fast RAM, and not C for Chip or E for Either. To conserve even more chip RAM, hold down the Ctrl and D keys while the start-up



Eye of the Beholder 2 is very intensive on chip RAM – if you haven't got enough then it won't load.

sequence is going – it should abort. Then type these two lines, pressing return after each:

```
Loadwb  
Endcli
```

You will be left with a very plain Workbench, but you should be able to run the game. Remember to close all unnecessary windows, since this saves a little bit more chip RAM. The system you have has 512K of chip RAM, while an A1200 has four times as much – 2Mb.

fect edits, every time, if your camcorder and VCR are single frame capable. No, you don't need one. Many independent producers use decks which are only accurate to two or three frames – although the cuts are not as predictable, you don't really want to spend most of your money on one VCR, do you?

Having said that, most 8mm camcorders and recent domestic VCRs do not produce a glitch when you edit – they have enough recording heads to handle perfect edits. The point is that you cannot predict, down to the frame, exactly when the edit will happen.

One dodge around this (which you probably already know) is to 'black' your tapes – record a blank signal over them first. The simplest way to do this is to leave the lens cap on your camcorder. If you edit too late, then you get black frames on your films – the trick is to start recording earlier than you need. Which means you lose a little of the pace of professional editing, but you don't pick up the price tag.

A600 FOR ADULTS

FROM: KEVIN LEWIS, SALISBURY

I own a C64. I'd like to sell it to make way for an A600. But recently I have heard several bad things about the 600 that are beginning to put me off. I'd like your opinion on a few points, as I might just



The A600 – not just kid's stuff. Better for beginner's than an A1200 though (that's a real complex machine).

buy an A500 so as to have a decent machine.

1) Is it true that the A600 cannot run games?

Some games which work on an A500 do not work on the A600. However, this only applies to games released before the A500 Plus came out (late 1991) – everything since then should work fine.

2) If so is it worth getting an A500 Plus just because it can run games?

Although it looks different to an A600, inside the A500 Plus is much the same design, so no. However, if a game or program uses the numeric keypad (the cluster on the right-hand side of most keyboards) then those functions will be unavailable on an A600, because it doesn't have a numeric keypad. For the most part we are talking flight simulations.

3) Is it true that the A600 can't copy programs?

Yes and no. Standard disks usable through Workbench (like the Coverdisk) can be backed-up without a problem. Like other Amigas, if you want to back-up copy protected games, then you will need some extra bits and pieces. But no back-up system is 100 per cent effective. If you want such a system, stick with the C64 and a tape-to-tape player, and then work out why nobody is writing games for the C64 anymore!

4) I have also heard that the A600 is actually worse than the old A500, and that it is the only reason why Commodore released the A1200. Is this true?

It depends on whether you want a games machine or a usable computer. Workbench 2 is much, much better than the 1.3 version supplied with the A500. True, if all you want to do is play old pre-1991 games, then the A500 is better. If you ever want to grow up and use a computer properly, the A600 is much better.

JUST KID'S PLAY

FROM: C R McCLEAN, CO ANTRIM

I am a teacher of children who have special educational needs. I have found that, for these chil-

dren who have difficulty with reading and writing, the computer and printer are invaluable educational tools.

In school I use a BBC Master computer, and an Epson dot-matrix printer. I have an excellent program called *Infant Writer* for this machine, which is very simple to use, and it produces a printout which is quite large and very easy to read.

So far, I have not been able to find a similar program for the Amiga. I use a Seikosha 24-pin dot-matrix with this. The Opal 12 medium font used with *Notepad* is not bad, but just not good enough. What I need is a simple, unfussy program to enable the children to type and print out sentences and short paragraphs. Is there one?

Yes, it's called *KidsType*, it costs £24.95 and you can get it from GeniSoft (0753 686000). Also, phone Deja Vu (0942 495261) and get a catalogue. These people do a lot of very cheap software which could prove invaluable in your work. *The Word Factory* from Deja

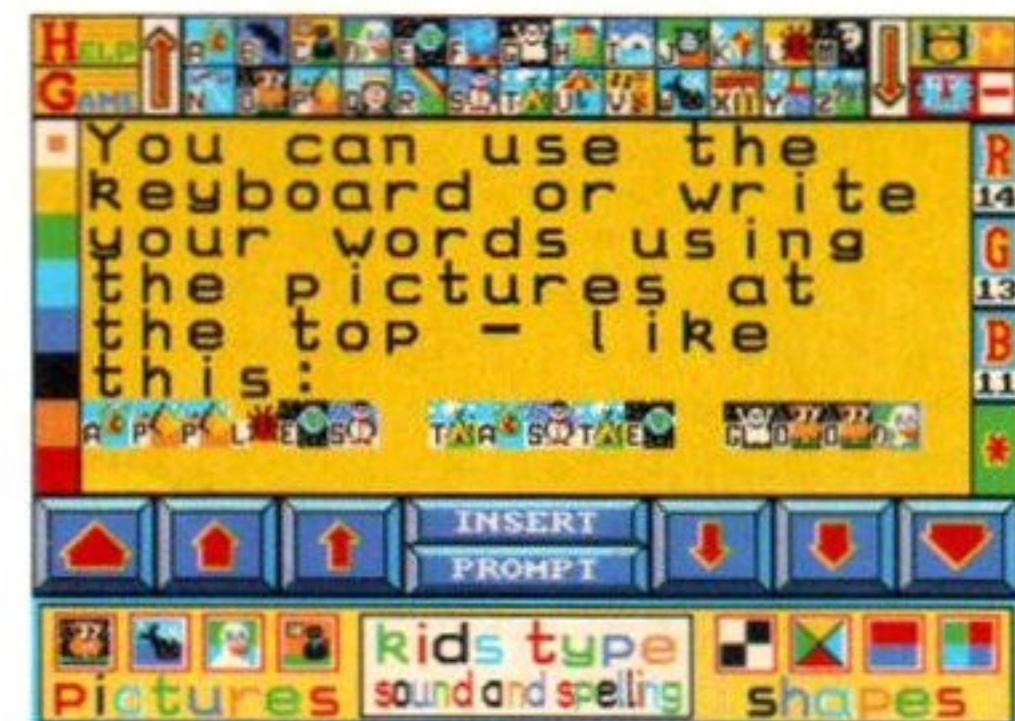

Children will be keen to learn when they use *KidsType* – it's simple and easy to use.

Vu is especially good.

MONEY MATTERS

FROM: DARREN A FENN, HUYTON

After having received a Star LC20 as a much wanted present (thank you!) I started writing some letters and doing some notes on your *Amiga Format* Collection *Scribble!* program.



Scribble! – one of the most popular of the Coverdisk Collection – but it won't print properly without a driver.

However, I've come up with a small problem. When I want to type a figure of money on the screen, it's no problem. But when I want to type a pound sterling (£) symbol, this is what actually gets printed out:

££££20.00

Could you tell me why *Scribble!* does this, as if I print out a pound sterling symbol with any other piece of software there aren't any Ys with dots over them?

Erm, you did copy the right printer driver from the Extras disk on to your Workbench, didn't you? And then set the driver through Preferences? I would tell you how to do this right now, but I seem to be heading for the end of the page. Here's a deal – if you haven't worked out how to do this by next month, I'll print a full explanation in the next issue. Best I can do for the moment... Oh, Marcus hath decreed another page for Workbench. Lucky for you he keeps moving the goal posts in the grand game.

Here's how it works. On a Workbench disk there's a drawer called Devs. Inside the drawer is another drawer called Printers. You can't see these on Workbench 1.3, but you can see them on Workbench 2 or higher by selecting Show/All files from the Windows menu. Workbench 3 users – there is a slight bug in the Workbench preferences, so you are going to have to wait until next month.

Anyway, all the printers for Workbench are kept on the extras disk – again in a drawer called printers. You have to copy the driver that you want (EpsonX or Epson X{CBM MPS 1250} work on the majority of printers) from the Extras disk into the devs/printers drawer on your Workbench disk. There is a handy utility on Workbench 1.3, called Install_Printer (it's in the Prefs drawer) and for 1.3 owners, I recommend you use that – just type in the name of the printer driver and swap the disks when requested.

For Workbench 2 owners, it's even easier. All you have to do is load Workbench, Show/All files, insert the Extras disk, double click on its icon, and double click again on the Printers drawer.

Scroll through the list of printers – it can take some time to find the one you want. Click on the icon and hold down the mouse button – you can drag the icon around. Move the pointer to the RAM disk icon and let go. The printer driver will be copied to the RAM disk.

Now look at the Devs drawer on Workbench (remember, you have to Show/All files to see it). Inside the drawer you will find another drawer, called printers. Drag the printer driver icon from the RAM disk to the printers drawer in the Devs drawer. Now

Techno Babble

Do you know how to talk techie speak? Well, if you don't then this little bit of jargon-busting should sort you out!

Accelerator: hardware expansion that gives your Amiga a faster CPU. Often used with maths-intensive software where a standard processor is too slow, for programs called 'raytracers' which literally trace the rays of light which bounce around a scene to produce a picture. Also used to considerably speed up flight and other kinds of simulations.

Anim Brush: a brush is a small section of a graphic screen, cut out with a paint program like *Deluxe Paint*. Anim brushes are different small images with the same dimensions – for instance, a bird flapping its wings or an eye blinking.

Blitter: BLock Image TransFER device. Used for copying large areas of memory from A to B, or to combine different areas into one single image. Widely used to generate large graphic shapes in computer games.

Bridgeboard: Commodore's own IBM emulating device, featuring a complete PC computer on a single card. Only fits A1500 and above machines – enables use of standard PC cards.

Chip RAM: memory accessible by the custom chips (Paula, Agnus, Denise) as well as the processor. Used to store all graphics and sounds. Can be used by programs too – with speed slow downs.

CLI: Command Line Interface. The program which enables you to type commands into AmigaDOS for standard operations like copying files or getting a directory. Shell is more commonly used now.

Copper: co-processor. Used to generate subtly coloured backgrounds – this device is built into the Agnus chip and it can alter colours while the screen is being generated. Executes instructions at the same time as the processor.

CPU: Central Processing Unit. The decision-making chip, the one that tells everything else what to do. It can be interrupted by custom hardware if its programs are in chip RAM.

Fast RAM: memory that's only accessible by the processor. Programs stored here run faster than those in chip RAM – hence the name.

Frame grabber: device for capturing live video data and converting it into computer picture data. Doesn't require a still video signal. Usually gives much better results than a video digitiser, which does the same job, except that the video must be paused.

Freezer cartridge: quasi-legal device for examining programs while they are running. Usually with many useful built-in utilities which help overshadow its dubious origins.

Hard drive: basically a big disk for keeping Workbench and all the serious software that you use. Works much faster than a floppy disk. More and more games are becoming installable on to a hard drive.

IFF: Interchange File Format. A standard way of storing pictures and sounds, invented by Electronic Arts and adopted by Commodore. A single standard – practically all art programs can load and save pictures in this form.

Kickstart: the name of the set of programs which are run when the Amiga is turned on. Also contains many library functions for use by programmers. Latest release is Kickstart 2.04. Other releases; 1.3, 1.2, 1.1.

PD: Public Domain. Literally, software that is the property of everybody. PD disks can be freely copied by anyone, and you can also distribute them to whoever you want. The correct term is 'Freeware'. 'Shareware' (try before you buy) and 'Licenseware' (commercial and non-distributable) also come under the same rough heading.

ROM: Read Only Memory. Memory that cannot be altered. Widely used as the starting programs for computer systems that have just been turned on – ROMs remember things permanently.

RAM: Random Access Memory. Memory that can be altered and re-altered many times. Typically, it does not remember what it contains when the computer's power is switched off.

Scanner: hardware device for reading flat pictures from posters, newspapers and so on, and converting them into computer graphics. Often used in desktop publishing to read in previously published images.

Script file: a set of commands which you would otherwise have to type into the CLI or Shell by hand, saved as a text file. Learning how to use Shell or the CLI involves learning how to write script files.

Shell: more up-to-date version of CLI. Works in exactly the same way, but enables some flexibility in what commands are called via the 'alias' function. Also gives some hot-key combinations to enable some editing of previously entered commands.

Sound Sampler: hardware device that converts electrical music signals (typically from a tape or CD player) into computer sound. Can also be used with a microphone to capture live sounds.

Sprite: a graphic object that is independent of the screen. On the Amiga, sprites are limited in size and colours. Typically used for mouse pointers, alien missiles, and so on.

Startup-sequence: the name of the script file, contained in the S directory, which is executed after a disk has booted. Typically contains just the name of a program to auto-run, but can be very complicated. Whatever the nature of the file, it must always be called Startup-sequence and live in the S directory.

Workbench: the set of programs which set up a graphical 'point-and-click' interface on the Amiga. Much more friendly than the CLI or Shell, but not as flexible. Always has to be loaded from disk, which is slow but does enable much customisation. Workbench 2 requires a Kickstart 2 ROM. Workbench 1.3 requires a 1.3 ROM, 1.2 needs a 1.2 ROM and so on.

Zorro: this the generic name for the Amiga's expansion connector. The A500, A500 Plus and A1000 had the original Zorro I; the A1500s and the 2000s have Zorro II; and the A3000 has Zorro III. They are not compatible, hence the different expansions for different machines. The new A600 has a PCMCIA connector instead.

Take Control!

Stuart Tavener's voltage controller design is AMOS controlled, fairly easy to build and cheap. **Pat McDonald** takes you through the instructions...

AMIGA FORMAT

190

MARCH 1993

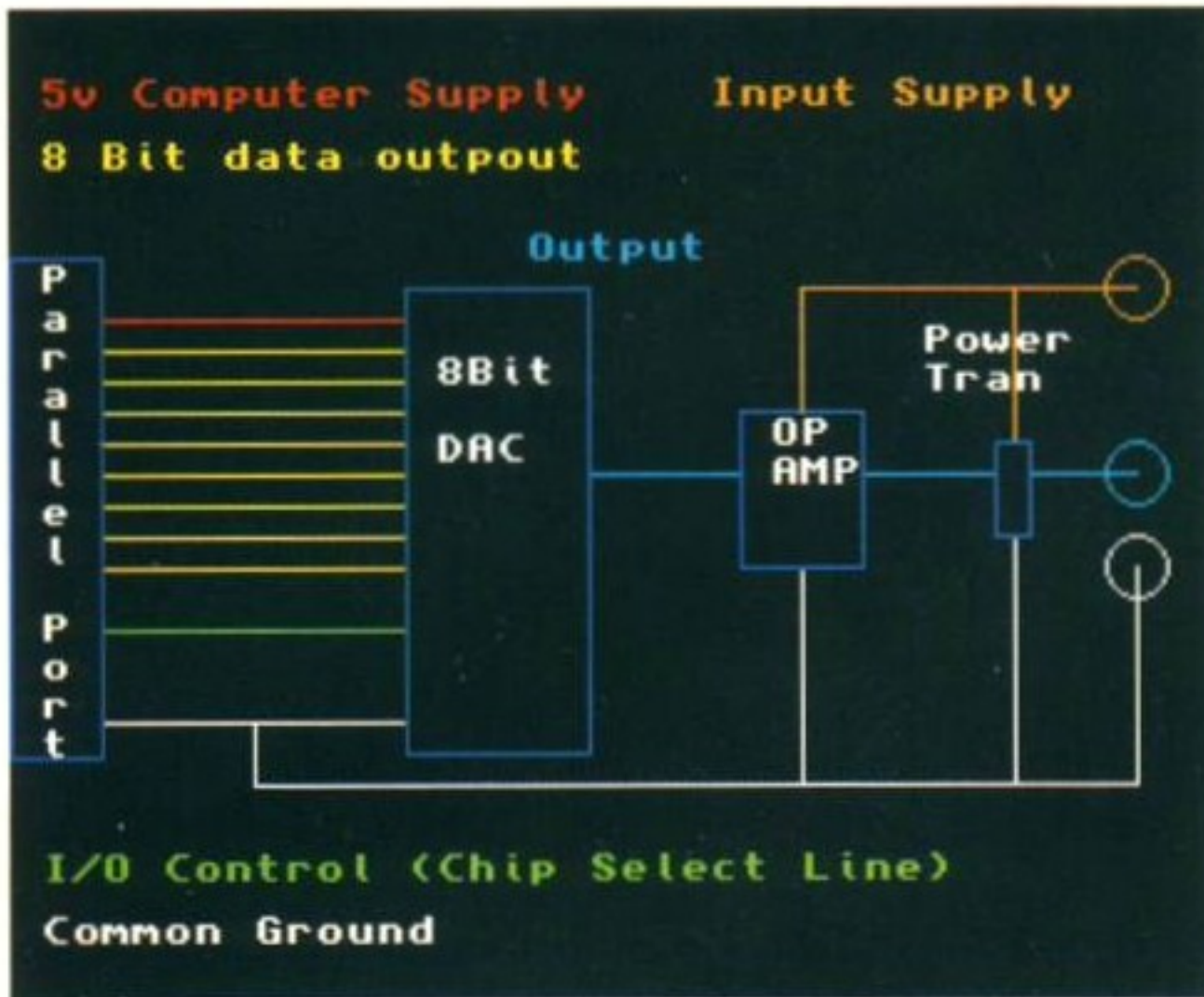

EVERY MONTH, WE receive dozens of requests from information technology students asking how they can go about building equipment to control hardware devices with the Amiga. Well here is one such project. On the Coverdisk, you will find most of what is presented here, together with the illustration for printing out. Assuming of course that you have, or know someone with a printer.

Building the circuit should present very few problems to a hobbyist, and indeed it's a good first project for those who know the theory, but have never actually built a circuit. You can either design a printed circuit board, or mount all the components on stripboard and connect the pins as described.

This is something we leave up to you – if you're a pupil at school, I'd recommend asking a Physics or Info Tech teacher for some advice on how to fit all the components together. If you're an adult and don't have a clue how to build it, try asking local TV repairmen (or poor electronics students) if they could build it for you.

This is a picture, which together with the words on this page should give you a rough idea of how it works. Your Amiga plugs into the left, and what you are trying to control goes into the right. The actual circuit is the bit in the middle, which translates the computer digital signals into analogue power signals to drive hardware.

HOW IT WORKS

This whole project is designed to plug into your Amiga's parallel port (always connect things with the computer turned off). Different values, between 0 and 255, are pumped straight into the DAC (Digital to Analogue Converter) chip. The DAC chip translates this into a voltage, between 0 and 2.5 volts.

This value is read by the amplifier chip in two stages – the first just gives out what it takes in, the second gives a value between 0 and 30V. This voltage is used to switch the power transistor to a given voltage.

It may seem unnecessary to have the first amplifier stage and the power transistor in there. The reason for the op-amp (optically isolated amplifier) is to make sure that no nasty voltages get passed back to the Amiga – it's there to isolate things. For good measure, the DAC also contains an isolator circuit (IC) – but it's wise to build a certain redundancy level into any circuit.

The power transistor is there to switch an outside power source (you have to supply this) between 0 and 30 Volts. The amplifier cannot give a high current output – there's only so much power available to the parallel port of an Amiga, and overloading it will knacker your computer. So stick to the circuit given and don't try to cut corners!

TECHNICAL NOTES

The DAC connects straight through to the Amiga's parallel port because it is micro-computer compatible and operates at the same voltage levels. The IC is not static sensitive so no special handling precautions are needed, although you shouldn't heat up the device if you're soldering it straight on to the board. It's a much better idea to solder a chip socket on to the board, and plug the DAC chip into that.

Either of the I/O lines 10, 11, 12 can be used to select the chip, but the program must be altered for each line, because they are at dif-

ferent addresses in the Amiga's memory map. Check the AMOS listing in the Serious-Stuff drawer on the Coverdisk. Pins 6 and 7 are voltage references for the DAC. I have told it to use its own reference level of 2.5 volts, so the maximum the DAC can output will be 2.5 volts. It can't output high current levels so a buffer stage is needed to stop the amplifying op-amp draining current from the DAC.

The first op-amp is just a voltage follower or buffer. It follows the input voltage, draining nearly no current because it has a high impedance. It can output the voltage totally separate of the input voltage and current, and so isolates the computer. Miss it out at your peril! The second op-amp amplifies the 0-2.5v from the DAC (via the buffer) and is amplified by the amount set by the preset (the 100k Potentiometer). It is much easier to vary the gain if a multi-turn potentiometer is used.

This output voltage can be between 0 to 30 volts DC. 30 volts is the maximum because it is the op-amp's maximum working voltage. Check the power transistor used can handle up this voltage. The last component is the power transistor. It supplies the same voltage as dictated by your AMOS program, but can supply more current when necessary. The TIP31C can supply up to 2 Amps. More capable transistors can be used but I find this to be ample.

The transistor can be directly soldered in if done quickly, but it can be mounted in some type of socket/holder. The output is then taken between the Emitter and ground, and can be used to power different applications including motors, solenoids, buzzers, lights and many more output type devices. I hope that this covers most of the workings of the circuit.

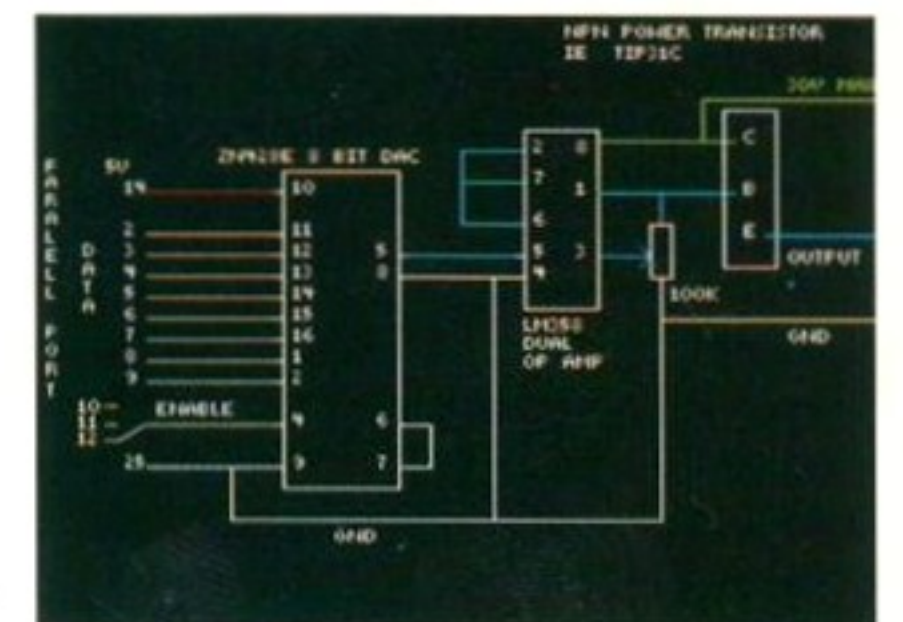

This is how all the components actually link together. Take great care when making sure that a wire goes from one place to another – it's easy to make a mistake. Check and double check before you plug in and turn the power on.

WHAT YOU WILL NEED

Description	Type	Quantity	Cost
8 Bit Latching DAC	ZN428E	1	£5.75
Dual Op-Amp	LM358	1	£0.28
IC Socket	16 Pin	1	£0.10
Power Transistor	TIP31C	1	£0.48
Variable Resistor	100k MultiTurn	1	£0.80
Note 1			
Parallel Port Plug	25 Way D-type	1	£0.68
Connecting Cable	20 Way Ribbon Cable	1 Metre	£0.72
Note 2			
Circuit Board	Varies		
Note 3			
Output Connector	Various	1 or more	
Note 4			
Total Cost			£8.86

Note 1. Multi-turn Cermet Presets are the best type to go for because they are compact and reliable.

Note 2. Only 11 wires are needed from the computer but ribbon cable is only available in 10 and 20 sizes, so some are spare.

Note 3. Depends upon the availability of different boards. Stuart designed his own printed circuit board, but stripboard (Veroboard) will work fine. Consult an electronics enthusiast if in doubt.

Note 4. Depending on its usage will depend upon the connector. Remember, you will need your own power supply to power the last part of the circuit and your own output devices.

All parts are available from Maplin Electronics – but do check out a catalogue before you order, as prices can change (both up and down) within days. Maplin can be contacted on 0702 554161.

ONLY THE BEST COMPUTER SOFTWARE

If you do not see a title you require ring for 30% off RRP

HIGHLY RECOMMENDED AFG - AMIGA FORMAT GOLD			
AH37-Thunderhawk (AFG)	£19.99	Fascination	£18.99
Air Land and Sea (AFG)	£91.99	Freede	£18.49
B.A.T. (AFG)	£16.49	Free Wheel	CALL
Battle Command (AFG)	£15.99	Fantastic Worlds	£99.99
Battle Isle (AFG)	£18.99	Gunship 2000	£21.99
Carl Lewis Challenge	£15.99	Hero Quest 2	CALL
Championship Manager	£16.49	History Line (AFG)	£21.99
Chuck Rock (AFG)	£16.99	Humans	£18.99
Civilization (AFG)	£91.99	Indiana Jones Fate of Atlantis (Arcade)	£15.99
Crazy Cars 3 (AFG)	£15.99	Indiana Jones Fate of Atlantis (Adventure)	£23.99
Dune	£19.99	Joe and Mac	£16.49
Dynablaster (AFG)	£19.99	KGB	£18.99
Espana Games	£18.99	Kick Off 2	CALL
Eye of the Beholder 2 (AFG)	£92.99	Krusty's Fun House	£16.99
F15-Strike Eagle 2 (AFG)	£91.99	Legends of Kyrandia	£99.99
F19-Stealth Fighter (AFG)	£18.99	Legends of Valour	£93.99
Fire And Ice (AFG)	£15.99	Lemmings 2	CALL
Formula 1 Grand Prix (AFG)	£91.99	Lethal Weapon	£15.99
JW Whirlwind Snooker (AFG)	£18.99	Nick Faldo Golf	£21.99
J. Madden American Football (AFG)	£15.99	Nicky Boom	CALL
Kick Off 2 (AFG)	£19.99	Nigel Mansell	£18.99
Laser Squad (AFG)	£12.99	No Greater Glory	£23.99
Links (AFG)	£93.99	No Second Prize	£16.99
Lure of the Temptress (AFG)	£19.99	Noody's Playtime	£16.99
Megalomania + First Samurai (AFG)	£90.99	Paladin 2	£18.99
Night + Magic 3 (AFG)	£95.99	Pinball Fantasies (AFG)	£18.99
PGA Tour Golf (AFG)	£18.99	Piracy	£19.49
Populous 2 (AFG)	£91.99	Populous - The Challenge Games	£9.99
Railroad Tycoon (AFG)	£91.99	Premier Manager	£15.99
Robocod (AFG)	£15.99	Premier	£15.99
Secret of Monkey Island 2 (AFG)	£93.99	Rampart	£15.99
Space Crusade (AFG)	£15.99	Reach for the Skies	£19.49
Wizkid (AFG)	£15.99	Road Rash	£15.99
		Sabre Team	£15.99
		Scrabble Deluxe	£20.99
		Second Samurai	CALL
		Sensible Soccer 93	£15.99
		Shadowlands	£18.49
		Shadow Worlds	£15.99
		Shadow of the Beast 3	£18.99
		Shuttle	£21.99
		Sim Earth	£25.99
		Sleep Walker	£16.99
		Street Fighter 2	£17.99
		Tear Away Thomas	£15.99
		Tiny Sneaks	£15.49
		Traders	£15.99
		Treasures of the Savage Frontier	£20.99
		Troddlers	£15.99
		Trois	CALL
		Universal Monsters	£16.99
		WWF Wrestle 2	£15.99
		Ween	£18.49
		Wing Commander	£21.99
		Zool (AFG)	£15.99
		Zyconix	£16.49

NEW TITLES

3D Construction Set	£31.99
AVBB Harrier	£91.99
Air Support	£15.99
Alien 3	£16.99
Amberstar	£18.49
Bills Tomato Game	£18.49
Bug Bomber	£15.99
Bunny Bricks	£15.99
Caesar (AFG)	£18.99
Campaign	£21.99
Combat Air Patrol	CALL
Cool World	£15.99
Cytron	£18.49
Delek Attack	£11.99
Dark Queen of Krynn	£20.99
Darkeed	£26.99
Doodlebug	£15.99
Dragons Lair 3	£21.99
Exodus	CALL
Fatal Strokes	CALL
Euro Soccer	CALL

TEL: 0272 401315/401316

MON-FRI 9.30am-6.30pm SAT+SUN TIMES VARY, Answerphone at all other times



O.T.B. COMPUTER SOFTWARE

7 CLEEVE WOOD RD, DOWNEND, BRISTOL BS16 2SF

All prices include VAT. UK postage add £1.00. Access and Visa accepted.

Please allow 7 days for cheques.

Prices subject to change without notice.



PHILIPS 8833 MKII

EX-DEMO
REFURBISHED AS NEW

£150.00

This price includes cable, delivery and V.A.T.

AMIGA A600 / A1200 HARD DISK DRIVES

Internal 2.5" IDE interface

20 Meg	£99.00
60 Meg	£205.00

This price includes cable, delivery and V.A.T.



TEL. 081 330 7533
FAX. 081 330 4838



COMMONSIDE LTD.

Unit 13, 193 Garth Road, Morden, Surrey SM4 4LZ

Price Busters!!

Graphics & General

AmigaVision	44.99	Hi Speed Pascal	64.99
AntiA	24.99	Home Accounts 2	36.99
Art Department Pro 2	129.99	Quarterback 5.0	39.99
Big Alternative Scroller	34.99	SAS C V6	199.99
Big Alternative Scroller 2	54.99	Turbo Print Pro 2.0	39.99
Broadcast Titler 2	149.99		
Deluxe Paint 4.1	54.99		
Charts & Graphs	59.99		
Expert Draw	49.99		
Expert 4D Jr	39.99		
Font Grabber	19.99		
Gallery - NEW!	39.99		
Gold Disk Office 2	79.99		
Hotlinks	49.99		
Imagine 2.0	169.99		
Maxiplan 4.0	39.99		
Morph Plus - NEW!	129.99		
Personal Finance Manager Plus	19.99		
Personal Font Maker	29.99		
Presentation Master	149.99		
Professional Calc	99.99		
Pro Draw 3.0	89.99		
Real 3D Beginners	99.99		
Real Things - Dogs	19.99		
Scala 500	64.99		
Take 2	34.99		
Video Director	99.99		
Vidi Amiga 12	84.99		
Vista Pro 2	49.99		
XCAD 2000	89.99		
XCAD 3000	279.99		

Hardware

Data Switch	19.99
Kick Back with 1.3 ROM	39.99
Colourburst	249.99
1.5Mb RAM with Clock	82.99
Invision Plus/Live	399.99
Flicker Fixer 2 A500	199.99
Naksha Mouse	22.99
Optical Mouse	29.99
Pendle 8802 inc Ext Cable	149.99
RocGen Genlock	84.99
RocGen Plus	129.99
RocLite Drive	54.99
RocKey	249.99
Podscat Graphics Tablet	179.99
Star LC200 Colour Printer	169.99
Star LC24-200 Mono Printer	189.99
Touch Screen for Amiga	229.99
3 Button Track Ball	34.99
Zydec Trackball	29.99
Zydec Amiga Drive	49.99
Zydec A500 1Mb RAM Card	44.99
Zydec A600 1Mb RAM Card	44.99
Sharp JX100 Mono Scanner	349.99
Sharp JX730 Colour Printer	899.99

Music & Sound

AD1012/Studio 16 Card	399.99
Aegis Sound Master	89.99
Audio Engineer Plus 2	149.99
Music X 1.1	49.99
Pro Midi Interface	19.99
Stereo Master	29.99
Techno Sound Turbo	29.99

DTP & Wordprocessing

Excellence 3.0	39.99
Final Copy 2 - NEW!	64.99
Kindwords 3.0	34.99
Mini Office	39.99
Page Setter 2	34.99
Page Stream 2.2	129.99
Pen Pal	34.99
The Publisher - NEW!	39.99
Protext V5.5	99.99
Transwrite	29.99
Wordworth 2.0 - NEW!	79.99
Works Platinum	34.99

Post & Packing £1.50 - Securicor £5.00
48 hour despatch - Cheques 7 days
Access and Visa accepted
(Cheques should be made payable to Softstore)

SOFTSTORE, PO Box 1720,
Slough SL3 0YX

0753 683336

Answerfile

Everybody who comes into contact with the Amiga has thousands of questions. Find out some answers with **Pat McDonald**.

Q I was rather confused by LGP Farmer's letter in *Amiga Format* 43, which seemed to indicate that the PC880B second disk drive was not compatible with the A1200. I'm confused because I bought such a drive and it works fine with the A1200 – so what's the full story?

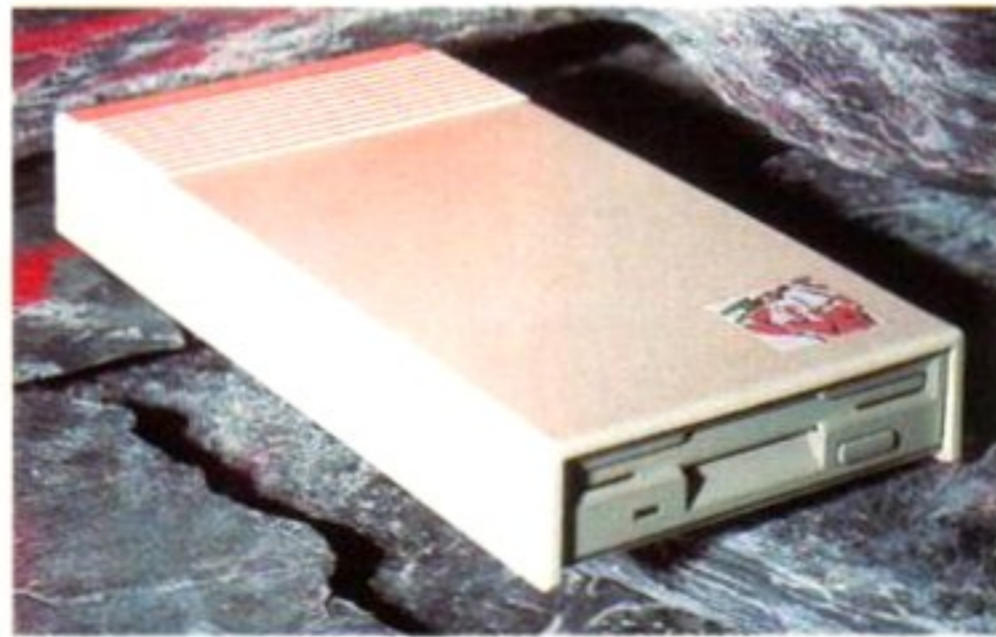

The Power Computing PC880B – once incompatible with the A1200, but current versions work fine. Just as well, since it's one of the better kinds of external floppy drive.

A Power have found that early examples of their PC880B drive do have compatibility problems with the A1200. The problem is in fact small and intermittent, but annoying all the same. Newer drives, typically less than one-year-old, are unaffected, and drives suffering from the problem can be made compatible by Power Computing for the sum of £15.

Q I seem to have either a virus or a duff Amiga – I keep getting Software Failure messages with Kickstart 2, and Guru Meditations with 1.3. I've checked all my disks with the SuperKillers disk from Safe Hex International, but no virus is ever found. What do you think the problem is?

A There might be a virus on your SuperKillers disk. It certainly used to be the case that a virus was put on to teach new users to be paranoid – later versions still have a virus on them, although usually it is neutered (incapable of spreading).

Some people think it's a laugh to alter virus killers so that they actually create viruses on your disks – neither Safe Hex International or I do this, but I mention it for those who got their virus killers from small PD libraries who can be a bit sloppy about such things.

Q What is a Guru Meditation?

A Exactly the same thing as a Software Failure – a program is trying to get the Amiga to do something that it cannot, like look at non-existent memory, divide a number by zero (the answer is infinity, which takes a long time to calculate), read a word from an odd numbered address or its simply overloading it with too many tasks.

The reason it's called a Guru Meditation is because when an Amiga falls over, it generates two numbers. The first number is the error code, the second number is where the error occurred in memory. The idea is that you send the codes to the programmer, who meditates over them (possibly using the optional Meditation Board – I'm not kidding) to find out why the program failed in the first place.

Commodore thought it was a bit silly, so you don't get Gurus on Workbench 2 or higher. Spoilsports.

Q I have a mini SCSI hard drive which I would like to fit in my A1200. Is this possible with an interface board? Where would I buy one?

A It is theoretically possible, but as SCSI drives are complex and expensive, why don't you trade it in for an IDE type drive? It's going to be a few months yet before SCSI interfaces come out for the A1200, so you are probably better off not waiting.

Q When I do a screen dump to my dot-matrix colour printer, the results are terrible – can they be improved?

A Yes they can, but you must understand that a dot-matrix colour printer with only four colour ribbons has an uphill struggle to reproduce a 4096 colour (or more with the AA chipset) Amiga screen. A company called Care Electronics (0923 672102) can provide you with *Flexidump 2*, which is capable of producing much better screen dumps than the standard drivers, for £39.95 – but don't expect miracles.

Q Where can I get information on creating custom bootblocks?

A Public Domain libraries. Either phone around or collect a few up-to-date catalogues – there are at least 10 Bootblock construction kits out there, but I wouldn't recommend any of them unless you are fairly conversant with how the Amiga works.

Q I have an A1200 – is the *Faster Vista* offer still open from Coverdisk 33?

A The offer is still open (I see no reason to close it) but the *Faster Vista* program doesn't work without an FPU (Floating Point Unit – a chip that does fractional maths much quicker than the processor). So unless you've got an FPU, don't bother!

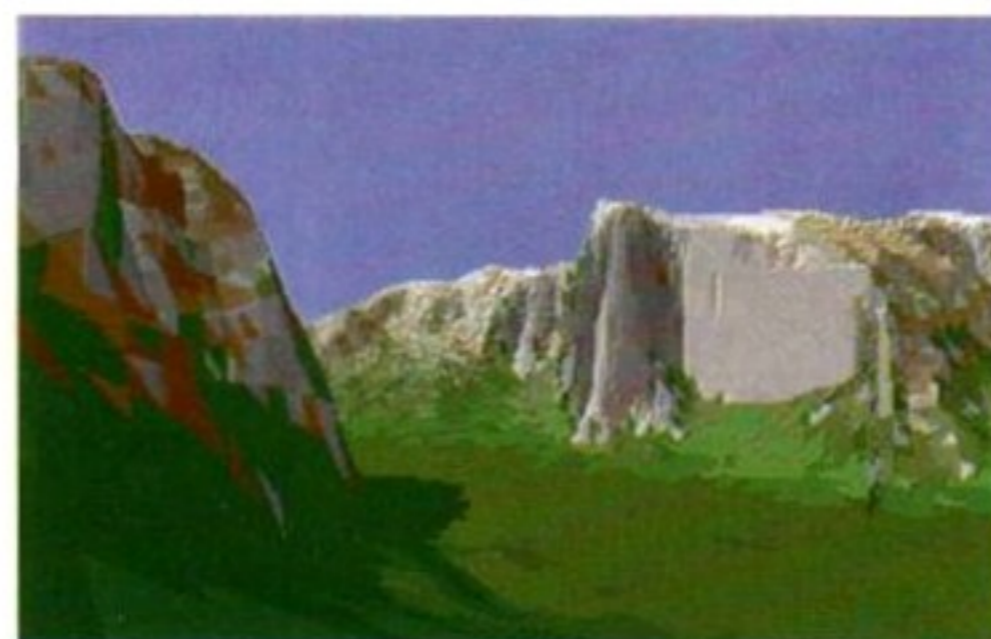

Vista, the first Coverdisk Collection program, can still be exchanged for an FPU version – but unless you have an FPU fitted, don't bother!

Q How do I print out drawings from *IntroCAD*?

A Load Workbench first. Then put in the *IntroCAD* disk and click on the icon. There was not enough space on the *IntroCAD* disk to include the printer device and its associated files – but you should count your blessings, the commercial disk didn't even autoboot!

Q How can I get Kickstart 1.3 for my Amiga 1200, to give greater compatibility with older programs?

A There is now a Public Domain disk called *Kick1.3*, that maps the old 256K Kickstart into chip RAM, so programs which need the old Kickstart ROM will work on an A1200 or A600. It's widely available from many libraries, but it still doesn't give full compatibility.

Q Where can I get some driver software for a lightpen? Making the thing was a doddle in comparison to finding some decent software!



The Trojan light pen works with most programs as a mouse – but it's useless without some driver software.

A Trojan, who make the Trojan Lightpen, may sell the software separately for about £20. It works best on Workbench 1.3 or 2, and you can contact them on 0554 777993.

Q How come some programs work on the A600, but not the A1200?

A Three reasons. Some programs which work on a 1Mb chip RAM system go belly up when they see 2Mb of chip RAM as fitted to an A1200 (this is fairly rare with post '91 software). Some software doesn't like the 68020 chip fitted to the A1200 – games like *Super Monaco Grand Prix* were designed totally around the 68000 chip, with no thought as to the future of the Amiga. Shame!

Finally, there are still minute differences between the Kickstart 3 ROM and Kickstart 2 ROM as fitted in the A600. These are mostly invisible (most games don't use the ROM anyway) but they still cause the occasional hiccup.

Q Do the batteries ever wear out on battery backed clocks?

A If the battery isn't rechargeable, then yes it will go flat every couple of years. Rechargeable batteries will automatically charge up when the Amiga is switched on, they are fairly bulky and have three solder connectors. Flat lithium batteries, while having

quite a long life span, do go flat. Lithium batteries are usually clipped on to A500 trapdoor RAM expansions, and can easily be replaced (that is if you can buy a compatible type locally).

Q Why don't some IDE hard drives work on the A1200?

A Two reasons. 3.5-inch IDE drives are too big to fit in the supplied mounting plate (some companies fit this type using their own mounting plates). Also, special cables are needed to connect them, and they take more power than a 2.5-inch drive.

Secondly, some 2.5-inch drives (especially the larger sizes) do not spin up to speed until they are accessed. This means that, although such hard drives can be fitted and used with an A1200 or A600, they will not autoboot. One solution is to fit a secondary reset circuit inside the computer, which makes it take a few seconds longer to reset – just enough time for the hard drive to get up to speed.

Q Where can I get a printer driver for the Hewlett Packard Deskjet 550C colour printer?

A WeServe do such a driver for about £10 – you can call them on 0705 325354. Also, a guy called PJ Warren, whose address is Watton House Farm, Bridport, Dorset, DT6 5JZ, has recently set up a quite extensive printer-driver service. He charges £1 per driver, including postage and packing.

Q Why is the Commodore power supply so duff? It doesn't just look bad, it's usually got really poor capacity, blows up at the drop of a hat and invariably breaks when dropped.

A Look pal, if you can design a better one, tell Commodore about it. UK HQ is at The Switchback, Gardner Rd, Maidenhead, SL6 7XA.

Q Can I use any CD-ROMs in an A570 CD-ROM drive or a CDTV? Can I use any ISO 9660 CDs in such units?

A No. Only CD-ROMs designed specially for the Amiga (CDTV is, when all is said and done, an Amiga) will work in these units. However, you can read all ISO 9660 formatted disks in the units – using Shell to copy files on to floppies.

You cannot run programs from foreign CD systems, but you can read any text files or convert pictures into the IFF Amiga standard using a suitable utility like *Art Department Professional*.



Although CD-ROM drives for different computers are incompatible, CD-ROM disks can be read by different systems. So you could use this A570 to read PC CD-ROMS. You can't run any programs, but you can look at text.

In-depth explanation No 12: CDTV Compatibility



When people are deciding between a CDTV and a CD-i, the deciding factor is often the fact that CDTVs can run a certain amount of Amiga software (assuming they have a floppy disk drive fitted). However, CDTVs cannot run all Amiga software – read the following points to gain insight on making a CDTV run more Amiga programs than has previously been possible!

1 One feature of the CDTV which persuades people to buy one (rather than a Philips CD-i unit) is the ability to use the rather large amount of Amiga floppy software. However, quite a bit of it will not work, for the following reason – the CD drive takes up 60K of memory, which reduces the amount of memory left for other programs. As a consequence, many of the better 1Mb programs will not work.

2 Disabling the CD drive is nowhere near as straightforward as, say, unplugging a floppy disk drive (or an A570 CD-ROM unit). Because there have been a few different revisions of the CDTV (which are all externally identical) then one of two different methods has to be used. Both of them work, but the second is better than the first.

3 The first works on nearly all CDTVs, but it invalidates your warranty, assuming you have one. Unscrew the case (don't forget the screws on the back) and lift the cover forwards. Locate the chip marked 'Odd' – if it is soldered to the board, then you have a very early unit and you should put it back together. Everybody else, gently lever the chip out of the socket from either end. Keep it safe in polystyrene or foam packaging.

4 You now have a CDTV which can't run Amiga CDs! However, 99 per cent of 1Mb programs should work on it and you can still play music CDs via the remote control or the front panel. Thanks to SJ Lunn of Spalding for this method – it's not brilliant but it does work on practically all machines.

5 If any companies want to start making sockets with a switch on the Select line, that would make life simpler. All you would have to do is take out the chip, put it in the socket and plug the socket where the chip came from. By flicking the switch (with the power turned off) you could choose whether you wanted a CDTV or an Amiga.

6 The second method is to check the inside of your CDTV with the illustration above. If you have a JP15 on the board, with a little jumper block on, move the jumper to bridge the middle and the other pin. Your CD drive will be disabled and you can use much more Amiga software. Thanks to Paul C Willows from Doncaster for that.

7 If you can get the bits, then wiring a switch to JP15 is an absolute doddle. You can just solder straight on to the pins, but it's a much better idea to solder the leads to a socket capable of fitting on to the three pins, and run three wires to a switch outside the machine. A suitable part would be Maplins FK97F, which costs less than £1. Maplins can be contacted on 0702 554161.

8 The reason why some software will still not run is because CDTVs have no fast RAM (memory usable only by the processor). Instead, all their memory is chip RAM (memory usable by the graphics, sounds and processor chips). The practice of writing fast RAM-dependent programs has always been frowned upon, but people still do it nevertheless.

9 One obvious solution is to fit some fast RAM to the CDTV, but this is not at all easy. There isn't a dedicated expansion bus on the CDTV, as you will find on all computers like the Amiga. The only possible way to do it (as I understand it) is to fit fast RAM directly to the processor socket – which is not easy, because space is very limited around that area.

10 So, there you have it. Next month I'll show you how to make Philips CD-i compatible with the Amiga. You will need; a large lump hammer; a bucket of blue steam; a sticky Commodore logo; and 14,000 gallons of multicoloured custard. And if you believe this last point, you'll believe anything (the rest of it's true though).

FED UP WAITING?



COMPUTER MATES (UK) LTD.

JUST ADD £2.00 TO YOUR TOTAL ORDER FOR A GUARANTEED * NEXT DAY DELIVERY TO YOUR DOOR

(* ORDERS MUST BE PLACED BEFORE 3.30pm excluding weekends)

All disks can be supplied formatted and ready to use for any IBM machines for as little as 4p per disk.

CHEQUES/POSTAL ORDERS TO:
COMPUTER MATES (UK) LTD.
PINWOOD STUDIOS, IVER HEATH
BUCKS, SL0 0NH

TEL: 0753 553535 (3 lines) FAX: 0753 553530

ALL PRICES INCLUDE V.A.T. & DELIVERY

FUJI FILM BRANDED DISKS

5.25" (360K) £5.00	5.25" (1.2 MEG) £7.00	3.5" (720K) £6.50	3.5" 2 MEG(1.44) £12.00
-----------------------	--------------------------	----------------------	----------------------------

LOOK GREAT DEALS ON FUJI

3.5" MF2DD 5 BOXES DISKS ONLY	£29.50
3.5" MF2DD 10 BOXES 100 DISKS ONLY	£55.00
1.44 MF2HD 5 BOXES 50 DISKS ONLY	£50.00
1.44 MF2HD 10 BOXES 100 DISKS ONLY	£95.00

AND £2.00 OFF ANY STORAGE BOX WITH PURCHASE PRICE OF £6.50 OR MORE

COMPUTER PAPER

2000 SHEETS PER BOX 80gsm	1 BOX	2 BOXES	3 BOXES
A4	£21.00	£38.00	£55.00
A3	£39.00	£75.00	£110.00

NEW JUST APPOINTED DEALER

DATA CARTRIDGES



GOLD MASTER BRANDED
2 FOR 1 LIFE TIME WARRANTY

	1 MEG MF-2DD	2 MEG MF-2HD
1 BOX	6.50	13.00
2 - 5 BOXES	6.00	12.50
6 - 10 BOXES	5.50	12.00

DC300A	£17.05	DC6320	£24.00
DC300XL	£17.50	DC6525	£28.00
DC300XLP	£15.50	DC1000 10Mb	£16.50
DC300EXL	£18.70	DC1000 20Mb	£16.50
DC600A	£15.50	DC2000	£13.50
DC6150	£17.50	DC2080	£16.50
DC6250	£24.00	DC2120	£16.50

QUANTITY DISCOUNTS: PLEASE CALL OR FAX

3.5" MITSUBISHI BULK MEDIA LIFE TIME WARRANTY

	DSDD	DSHD
50 Disks	£23.00	£35.00
100 Disks	£42.00	£65.00
200 Disks	£77.00	£127.00
500 Disks	£177.00	£297.00
1000 Disks	£330.00	£590.00

INCLUDES LABELS

NOTE: The above disk are based on > 55% clipping level, cheaper disks are available - please call.

COMPUTER MATES BRANDED DISKS

2 FOR 1 LIFE TIME WARRANTY

3.5" DISKS

	DSDD	DSHD
50 Disks	£23.00	£37.00
100 Disks	£47.00	£71.00
200 Disks	£87.00	£139.00
500 Disks	£202.00	£327.00

SPECIAL OFFERS THIS MONTH

LOOK SAVE YOUR EYES

12" or 14" COLOUR OR MONO FILTER SCREEN	Only £13.99
SAVE YOUR EYES	£25.00
Optical Glass Filter 14"	£25.00
Optical Glass Filter 20"	£35.00
12" or 14" TILT & TURN WITH HANDY KNOB	£15.95
MONITOR STAND	£15.95

PRINTER STANDS 5 DIFFERENT TYPES

PRINTER STAND (Feet)	£8.00
80 or 132 COLUMN	£5.00
IBM PRINTER LEADS	£5.00

JOYSTICKS ALL MACHINES P/C
LABELS 5.25" OR 3.5" (5.25" WITH W/P)
100 £1.00, 1000 £8.00. SINGLE OR MULTICOLOUR AVAILABLE

PRICE BREAKTHROUGH ON HAND HELD VIDEO GAMES



GAMES AVAILABLE AT ONLY **£12.99**

P.52 Sea Battle, Grand Prix, Challenger Tank, Brain Power, Carrier, Linear Racing, Super Block, Snake, Hashblock/Eagleplan, Honey Bee, Space Fighter, Alien, Tennis Pro, Olympic Trails, Police Bust, Pacboy, Block Buster

£39.99 inc.
SUPPLIED WITH:
* CRYSTBALL GAME
* BATTERIES
* STEREO EAR PHONES

SPECIAL PACK OFFER
BUY 4 GAMES - CHOOSE ANY OTHER TITLE FREE

5.25" BULK DISKS

Packed in 25's with Envelopes, Labels, Lifetime Warranty

	48tpi	96tpi	HD
25 Disks	£8.50	£8.75	£12.00
50 Disks	£16.00	£16.25	£23.00
100 Disks	£28.00	£27.25	£36.00

1000+ PLEASE CALL

MICE/TRACKERBALLS

PS2 MOUSE	£21.00
AMIGA/COMMODORE	£19.00
ATARI MOUSE	£19.00
ATARI/AMIGA TRACKBALL	£22.00
MOUSE MAT	£2.50
MOUSE POCKET	£2.50
MOUSE STAGE	£10.00
MOUSE MAT HARD	£3.50
PAPER TRIMMER	£5.00

COMPUTER DESK...£90.00



COMPUTER CHAIR...£40.00

QUICKSHOT JOYSTICKS

MULTI SYSTEM

QS11A Turbo 2	£9
QS149 Intruder 1	£25
QS128F Maverick 1	£14
QS155 Aviator 1	£27.50
QS131 Apache 1	£7
QS130F Python 1	£9.50
QS127 Starfighter Pair Remote Control	£36.50
NINTENDO	
QS130N Python 2	£9.50



Up to £3.00 OFF above Joysticks with another purchase above £15.00

STORAGE BOXES

3.5" DISK CAPACITY	5.25" DISK CAPACITY	STACKABLE BOXES
140.....£11.50	140.....£9.00	Disk Name Cap
120.....£9.50	120.....£8.50	3.5" Banx 80.....£12.99
100.....£7.90	100.....£7.50	Dual Banx 5 130/180.....£14.99
80.....£7.50	50.....£6.50	3.5 Bimby 200.....£18.99
50.....£6.50		5.25 Bimby5 200.....£18.99
40.....£6.00		

BIMBY BOXES CAN ALSO HOLD 3 2.8" VIDEO TAPES, CARTRIDGES
ALL ABOVE BOXES LOCKABLE + 2 KEYS.
£2 OFF BOXES WHEN ORDERING 100 BULK DISKS OR MORE
3.5" or 5.25" 10 Cap...£1.50, 5 Cap...£1.15, 1 Cap...50p
Cardboard Disk Masters...£150/1000 or £25/100

DUST COVERS

AMIGA/ATARI	£6.00
12" or 14" MONITOR	£6.00
80 or 132 PRINTER	£6.00
LAZER PRINTER	£6.00
84 or 102 KEYBOARD	£6.00
TOWER CPU	£6.00

DUST COVERS FOR MOST SYSTEMS - PLEASE CALL

CLEANING ACCESSORIES

MINI VACUUM CLEANER	£7.00	HEAD CLEANER 3.5" or 5.25"	£2.50
MONITOR CLEANING SOLUTION	£3.00	ALL THE ABOVE & MORE	£11.00
3" CLEANING KIT	£3.00		

DATA SWITCH BOXES

CENTRONICS OR SERIAL	2 WAY	15.00
4 WAY	DATA SWITCH LEADS	.8.00 each

COPY HOLDERS

A4 Desk Top Anglepoise	£15.99	Paper Clip Monitor Side	£4.00
A4 Anglepoise G-clamp	£15.99	Paper Clip Monitor Top	£5.00
A4 Desk Top	£8.00		

LOOK!

VIDEO TAPES, £180, LIFETIME WARRANTY, 3 HOURS
10 FOR £20; 50 FOR £90

RETAIL PACKED BLUE BOX DISKS

ALL BLUE BOX DISKS ARE COMPLETELY PACKAGED IN BLUE PRINTED CARDBOARD BOXES WITH LABELS. 100% GUARANTEED FOR LIFE

3.5" 720K-880K	3.5" 1.44 Meg	5.25" DISKS
MF-2DD 10's 1 Meg	MF-2HD 10's 2 Meg	M-2D 48TPI 360K
1 Box.....£5.00	1 Box.....£8.50	1 Box (10).....£4.00
MF-2DD 30's 1 Meg	MF-2HD 30's 2 Meg	M-2DD 96TPI 720K
1 Box (30).....£14.00	1 Box (30).....£21.50	1 Box (10).....£4.75
BAMBI-2DD 1 Meg	BAMBI-2HD 2 Meg	M-2HD 1.6 Meg H/D
25 Disks in 25 Capacity Storage Box	25 Disks in 25 Capacity Storage Box	1 Box (10).....£5.00
1 Box.....£14.00	1 Box.....£21.00	

10% DISCOUNT GIVEN ON 10 BOXES OR MORE

CALL SAM OR PAT NOW! ON 0753 553535

FED UP WAITING?

ALL ORDERS ARE NORMALLY DELIVERED TO YOU WITHIN 48 HOURS

HOW TO CONTACT AMIGA FORMAT

You can be certain of getting your enquiry to the magazine dealt with, but only if you make sure you're addressing your letter to the right person or place.

- We can never give personal replies by mail, so don't send us a stamped-addressed envelope.
- We can under no circumstances give personal replies by fax, so please don't ask us to.
- We are available for enquiries by telephone every Tuesday between 10.30am and 6pm, and we'll be happy to talk to you then.
- Our advertising department can help with problems concerning companies who advertise in the magazine if you phone during normal office hours.
- Our subscriptions service and the **Amiga Format** Mail Order department are not in the same building. They can be contacted on 0458 74011.

WORKBENCH

If you have any problems with the technical side of your Amiga, with hardware or serious software, Pat McDonald will try to answer you in the mag. Or, if you have any advice for others or any handy tips to share, send it in and you could win a prize.
WORKBENCH, **AMIGA FORMAT**, 30 MONMOUTH STREET, BATH BA1 2BW.

GAMEBUSTERS

If you've just found the cheat mode, mapped out the levels or found all the passwords for the latest game, send the info to Nutts and you could win a prize. Or, if you're stuck, ask Helping Hand for advice – or solve someone else's problem and win a prize!
ANDY NUTTALL, GAMEBUSTERS **AMIGA FORMAT**, 30 MONMOUTH STREET, BATH BA1 2BW.

LETTERS

The letters pages are there for you to air your views and share your opinions: please remember not to ask questions that should be in Workbench! Marcus is looking for thought-provoking or entertaining letters, the shorter the better. Prizes given for the best two.
LETTERS TO THE EDITOR, **AMIGA FORMAT**, 30 MONMOUTH STREET, BATH BA1 2BW.

COMPETITIONS

To enter a competition, write the answers and your name, address and phone number on the back of a postcard or a stuck-down envelope and send it in. You can enter as many times as you wish, but all entries must be posted separately: don't put several entries in one envelope together, or include entries with letters to any other part of the mag.
COMPETITION, **AMIGA FORMAT**, 29 MONMOUTH STREET, BATH BA1 2DL.

SPECIAL OFFERS

If you've ordered something from the **Amiga Format** Mail Order section and you've got a problem, please remember that we on the magazine don't deal with it at all. Write to Mail Order at our Somerton address or telephone 0458 74011.
AMIGA FORMAT MAIL ORDER, THE OLD BARN, SOMERTON, SOMERSET TA11 7PY.

SUBSCRIPTIONS

Similarly, if you move house and want to make sure your copy of the magazine catches up with you, or if you have any other subscriptions enquiry then write to: **AMIGA FORMAT** SUBSCRIPTIONS, THE OLD BARN, SOMERTON, SOMERSET TA11 7PY.

FAULTY COVERDISKS

The disks are duplicated and stuck on the magazine by a firm we employ for that specific purpose. If you have a faulty disk, send it to them enclosing an SAE. We don't keep stocks of disks, so we can't help.
DISCOPY LABS, UNIT A, WESTMARCH, LONDON ROAD, DAVENTRY, NORTHANTS NN11 4SA.



Letters

Hi! and welcome to the bit of Amiga Format where we take a back seat, and let you have your say. Whatever it is you want to talk about, just get it off your chest and down on to paper. If it's of interest to us, or more importantly, of interest to other readers, you could see your name in lights, up there on the hoardings over Broadway. Oh! all right then, in bold type right there under your ideas and opinions. So send your letters to us at this address:

Letters, **Amiga Format**, 30 Monmouth Street, Bath BA1 2BW.

DOES SIZE MATTER?

Why did you change the size of the magazine on Issue 26? Why have you changed the size of the word *Format* on the cover and why do other magazines sometimes review games a month before you do?

Jonathan May, Headcorn

You have got a long memory. The reason we changed the size of Amiga Format's pages a year-and-a-half ago was because, despite what Dr Ruth may say, we really do believe that bigger is better. We thought that we could fit more advice, tips and info in every issue, and that has to be better for you the readers. The reason we made the word Format on the cover bigger was that one or two other magazines had changed their logos so that they were more like our own, and some readers were actually buying the wrong magazine by mistake. So we made the Format bit of our name bigger to avoid confusion.

The reasons why we sometimes review games after other magazines are twofold. Firstly, and most simply, different magazines go to the printers at different times of the month, so sometimes a game's release date simply falls at a time that is convenient for one mag, but too late for another. More importantly, some magazines review games that aren't finished, or review games 'on site'. This means that they go to the software house, or the software house comes to them for a day, and they play the game for a while, do some screen grabs, then write the review.

Amiga Format will not do either of these things. We know how much games cost, and we will not judge a

game without giving the finished version several days of play. Only then do we believe that we can make an advised recommendation to you.

JUST SAY NO!

PRIZE

I am writing to tell you that I spotted an Amiga on television. It was on BBC1's *Casualty* on Saturday 9 January. There was a black Zipstick joystick plugged into it and *Fantasy World Dizzy* was on screen. "I didn't buy you that for games, you know!" said the girl's mum. The girl by the way, was taken to casualty because she took a huge overdose of paracetamol and ended up with liver damage. My advice to her is to stop eating drugs like sweets and practice her gaming a bit more, then she might be able to get off the first screen of *Fantasy World Dizzy*.

Chris Hamilton, Grangemouth

And we agree with you wholeheartedly, everybody knows that only dweebs take overdoses instead of playing computer games on their Amiga. You, Chris are the absolute, total, last and final person to win a prize for spotting an Amiga on TV. OK, get that folks? If you see a Commodore home computer on the goggle box, we simply don't care, they're far too common now. If on the other hand you manage to spot one on a proper shown-at-the-cinema motion picture, we may be persuaded to bung you a prize. The Hollywood Amiga hunt is on.

Continued overleaf

The Gallery
Sponsored by **MAX**
Graphics

Got a picture you're proud of? Send it in, see it in print and win an *Amiga Format* binder! Since Letters is where you get to contribute your words, we thought it would be the perfect place to see your pics on display too. The best image every month will win a huge (and we're talking big here) poster print out, courtesy of Max Graphics of Cardiff – worth a massive £80. Send your entries on a floppy disk to The Gallery, *Amiga Format*, 30 Monmouth Street, Bath BA1 2BW.



Ranma by Eugenio and Edoardo Perinelli of Verona.

PIRATE PD

Recently, I heard of a group of text files on a disk which went under the name of Jolly Roger, I heard that it was 'excellent', and so I was naturally curious. I was, however, appalled when I booted the disk, and even more so when I read some of the files on it. I believe that a document similar to this was published a few years ago, and was immediately banned. The files are of a truly terrorist and criminal nature, including how to make bombs, how to make LSD and how to commit credit-card fraud. This must break an astounding amount of laws, and I felt it necessary to take some action. I hope that you can at least be responsible enough to issue a warning, especially to parents.

Anonymous

We saw this disk a few months ago, and decided that giving it coverage in our Public Domain column was likely to attract people to it. After all remember the Frankie Goes To Hollywood affair, where their previously unheard of single Relax shot to number one when Mike Read banned it from breakfast Radio One.

In this case however, we do think that we should draw the attention of people and, as you say, particularly parents to this disk. You have been warned.

SEUCK ME

I have made a SEUCK game. How can I get it sold as Public Domain? What do you think of the Acorn A3010 in competition with the A1200?

Neil Seepujak, Sheffield

You can't get your program sold as PD, the whole idea of PD is that you give it away. But if you want your game distributed for free, simply send it to a few of the PD houses - some addresses are on our PD pages (185-190), and if it's any good, within months you'll find it spreading here, there and everywhere. If it's very good, you may even see it reviewed in PD Update.

The Archimedes... competition, what competition?

THIS PARROT IS DEAD

How dare you compare Monty Python and Beadle's About in the same sentence. I am referring to the terrible first paragraph of the Lemmings 2 Coverdisk section in the January issue.

I am sorry, but if this happens again, I shall be forced to send the Spanish Inquisition round with the soft cushions and the comfy chair!

Fred, the dead parrot

Here at Amiga Format we dare do anything, even compare the absolute best and worst of British TV comedy in one succinct turn of phrase. And if you threaten us again we will be forced to send Jeremy Beadle round to dig up your garden, and crash your mum's car.

BRAVE NEW WORLD

In the December issue you had an article on virtual reality. This was a very good piece of reporting, and very forward thinking.

One thing that struck a chord with me when I was reading this, though, was an article in *Amiga Format* on the new chip set that enables full-frame video on CD. Your idea explored the notion of an interactive TV channel, so that viewers could select from a library of videos to watch.

My point is that with fibre optic technology, would it be possible to create a centralised VR system? Optical fibre opens up the world of interactive home use because data travels at the speed of light. You can now have a non-delayed conversation with someone in America via this technology. Data travels down these fibres at a rate of 2.5GBytes a second.

Imagine a time in the future where one could go along to a computer store and buy a headset, gloves and a subscription to a Virtual Board, then go back home and plug the set straight into a wall socket. They could then link up with other users on the system and go do battle in some Virtual Fantasyland. Just think, in a few years gaming on a centralised A6000VR machine could well be possible.

Colin Ford, Watford

It's a nice idea, isn't it Colin, but a few optical fibres and the MPEG chip set are not going to make it an actual reality. Networked VR is still a long way off, and it isn't just data transfer that is the problem. Processing power is also a major hurdle that would have to be tackled. Each player's position, direction of view, and motion has to be calculated both relative to the virtual environment, then relative to other players. Today's VR systems have enough trouble calculating just one player in relation to the environment. So rather than a central A6000, even if, as its name suggests, it were powered by a Motorola 68060 chip, running mutual virtual reality, it would more likely be a Cray MXP.

We're not rubbishing your idea though, we just think you are looking a long way into the future. But then, when I bought my Vic-20 (3.5K of RAM and an external tape drive) I never thought that 14 years later I would be buying a 32-bit computer with 2Mb of RAM and a built-in disk drive. So, who knows? Maybe a VR network is only a few years away?

SEGA POWER

I have just bought a Quick Shot Python joystick, and on the bottom there is a switch that you have to change depending on the system that you use it with. I was playing *Project-X* with my new joystick and I changed the switch from A for Amiga users to D for Sega Mega Drive users to see what would happen. I pressed both

Continued overleaf

1200 WORDS ON

I read with interest your review of the new A1200 (I read it in *Smiths*), but would like to point out the deliberate mistake.

You forgot to list most of the disadvantages - still the crappy old two-channel per speaker sound and a low-density disk drive. The low-density disk drive is obviously to make sure A4000 owners never see software on HD disks, and to ensure the user gets maximum disk swaps per program.

How you can let Commodore get away without even a hint of disapproval is totally beyond me. Does Kelly Sumner pay you vast amounts of money not to criticise them or something?

I think I speak for the majority of Amiga owners when I say this. I don't buy *Amiga Format* for the sole reason that you arse-lick Commodore. When are your writers going to start writing their real views? Surely you have a large enough circulation to survive without Commodore's approval.

Feel free to try and defend yourself - I will understand if you don't.

Paul Markham, Stone

Having read the review in Smiths, Paul, you obviously didn't have time to study it carefully. Rather than defend Commodore's decision to omit the items you have described, we analysed their reasons for doing so. We concluded that the inclusion of an improved sound chip and high-density drive would have taken the A1200 above the desirable £399 price point.

Rather than sucking up to Commodore, we did what we always do, and expressed our own opinion, which is that the A1200 is the best home computer for the price. You assert that you do not buy Amiga Format merely for our sycophantic attitude to Commodore, if you were reading (what will be) someone else's copy in Smiths, it seems you don't buy it at all.

I've bought a new A1200, and so far I am very happy with it, having found that about 85 per cent of my existing software to be compatible with it.

However one thing that really annoys me is that the A1200 is supplied with less than half the documentation of the A4000. The user guides for AmigaDOS, ARexx and hard drives should also be included. I contacted Commodore and they are unable to supply copies of these manuals.

Surely if Commodore want the A1200 to be treated as more than a souped-up games machine, then the least they could do is supply full documentation for it.

Vince Suttle, Giggleswick

Absolutely right there Vince, how can any user be expected to get the most from this amazing machine without the AmigaDOS and ARexx manuals? We suspect, though, that when Commodore say they are unable to supply the appropriate man-

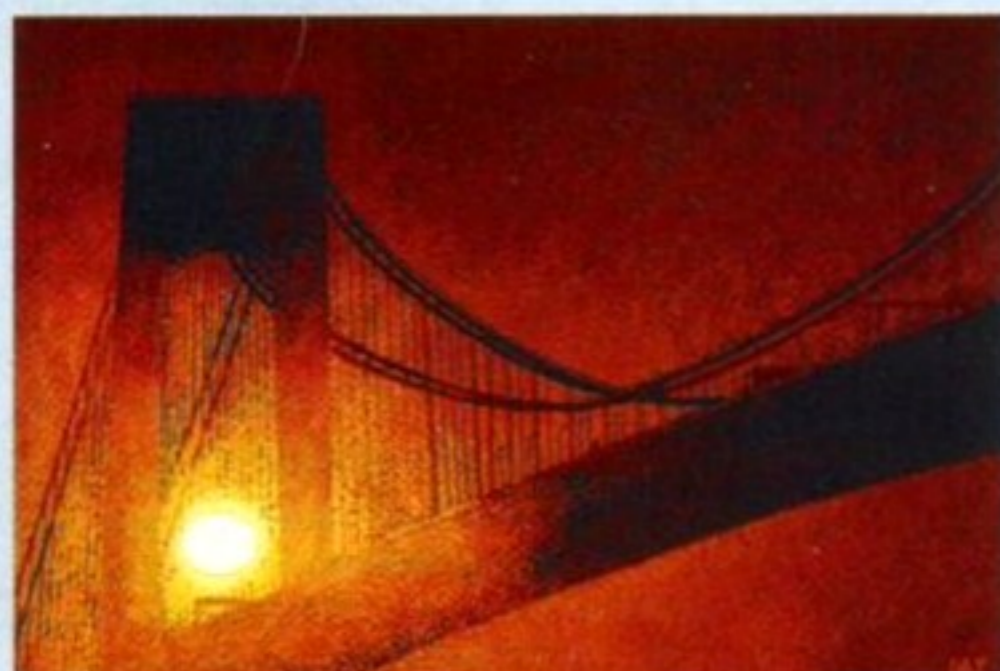

Sunset Bridge by Barren Barwise of Doncaster.



Beep by Neil Casini of Nottingham.



Noonan as a lemming by Michael Rose of Newbury.

THE AMIGA 1200

uals, they actually mean that they are unwilling to. Let's face it, they publish them in the first place. The hard disk manual is a necessity with the A4000, but not for the A1200. We would hope that when A1200HDs do become available the said manual will be included. Maybe Commodore have something to say on the subject.

Having seen numerous pictures of the new A1200 and A400, I can't help noticing that they both have newly designed mice. I would have thought that you could have at least mentioned it since the old design was extremely unreliable. Even after cleaning, mine sometimes refuses to move at all, and my left button is almost as bad as the right one, which sticks repeatedly. I've seen letters complaining about the old mouse in your mag.

C Taylor, Hebden Bridge.

It's not surprising that you have seen letters slugging the old Commodore rodent, we always thought it was a dog (I hope you're reading this Mr Markham). The new one is much better, and it was remiss of us to omit mentioning it in our reviews of the new machines. Our only defence is that we were so bazzagrammed by the other incredible features that we overlooked this small but vital feature. While the new mouse is a vast improvement, you still can't beat a good third-party mouse like the Golden Image, Naksha or MegaMouse.

Just what are Commodore doing? It seems to me that they have no idea of which direction their products are going.

The 1Mb A600 sells for £299 and the 2Mb A1200 sells for £399. At first the price difference may seem quite big, but pay out for another 1Mb of memory for the A600 and it brings the price dangerously close to the A1200. I can't help feeling that there are a few recent A600/CDTV owners fed up with Commodore. The A1200 is the way ahead, and Commodore should see that all machines are up to this spec.

Jason Theobald, Billericay

I have bought an A600 thinking that it would be an interesting upgrade to the Plus. But after reading the December

issue of your mag, about the A1200, I am left wondering what Commodore are trying to do. Are they trying to cheat us out of our money, then bring out a much better computer for the same price as the A600 cost just a few months ago? Now the A1200 is out how do Commodore expect me to sell my A600? Are Commodore using the A600 as the C64 of the Nineties?

Paul Hudson, Hedgesford

We've had a few letters like this, and they really disappoint me.

Owners of Ford Escorts don't write in to Autocar and Motor slugging Ford off every year when they announce an extensive range of improvements in the new model range. Hi-fi owners don't howl in annoyance in letters to What Hi-Fi when Nakamichi bring out a new cassette deck with more features than theirs. So why are so many people upset that Commodore have shown a firm commitment to keeping the Amiga up to date? If the Amiga isn't constantly updated and improved it will fall behind, become less attractive to developers, who will then stop producing software for it. Unlike a car or stereo system, Commodore can't just add electric windows or surround sound to the Amiga; when it's updated it has to be a fairly thorough process. Otherwise there would be hundreds of different configurations of machine, and the software incompatibility problems would be gargantuan.

By launching the AGA chipset Amigas, Commodore haven't abandoned A500/Plus/A600 owners, instead they have revitalised the market, and ensured that those machines will be supported with software for years to come.

As for the A600 being the C64 of the Nineties... The C64 has survived for over 10 years, selling strongly for the entire duration, notching up total sales of over one million units. The A600 would be doing very well to match, or even get close to this incredible success story. And remember that C64 software was only compatible with the C64 itself (we'll ignore the C128). The A600 can make use of software written for the A500 before it, and the A1200 in the future.

We say... if you own an Amiga, you're lucky. You're part of a big family.

Next month Issue 45 April 1993

Just what is multimedia anyway?



A picture. If you get lots of these, add some sound and make them all work at the press of a button, you've got yourself a multimedia thing. But what are you supposed to do with it? We find out how multimedia is changing your life, and you don't even realise it.

Everybody knows what multimedia is, right? I mean it's... well it's got to do with CDs and high-end workstations doing... erm. OK, so not everybody knows what multimedia is, or what it can do. But in the next few years it's going to be creeping into your life through the back door. So we're going to find the guys who know all about it and ask them the difficult questions. Like: what is multimedia? How can we do multimedia at home? And what can multimedia do for us, the Amiga owners? So join us next month as we blow the lid off the biggest buzzword in modern computing.

The great AF IDE guide

If you've got an Amiga 600 or an Amiga 1200, you may have noticed it's got a hole in it. Oh yes it has, just take a look at the left-hand side of it. All right, it's more of a slot than a hole, but it's called an IDE port. Next month we'll be looking at what they are, what you can do with them (ie expand your Amiga), and how much they cost.

Waiting for you at your local shop
from **March 11!**



The Opposing Tide by The Hairy One of Saltash.

The
Sponsored
by
Graphics

GALLIE

of the fire-buttons and the top button was still the fire-button, but the other button chose the special weapon, so I didn't have to press the spacebar. This makes the game a lot more playable, and it may work for other games involving magic, power-ups etc.

Simon Askham, Leicester

He's right you know, we tried it with a Sega joyypad and it works. Oh no! I can see weeks of frenzied Project-X playing ahead, just like when the game first arrived in the office.

ST USER

Please could you give me some insults for Atari ST owners because I am sick of hearing 'ST this, ST that'. Oh yeah and which is better, the A1200 or the Falcon? I also saw an Amiga in *Wayne's World* when Garth was sending Cassandra's video to the record executive.

Peter McKearney, Dungannon

You mean you know some people who still own an ST? Then again, I suppose they find them a bit difficult to get rid of these days.

The Falcon is better than the A1200, Epic was the best game of last year, The Sun goes round the Earth, and Wayne's World was a crap film... NOT!

PD PROMO

Some time ago you told us Commodore were going to launch a big promotion campaign for the Amiga, and I did see some posters with an A600 on them, telling us it's not just a console. But a poster doesn't say much, does it? Both Nintendo and Sega know this and are advertising in an aggressive way on TV. That's what Commodore should be doing; don't tell us what the Amiga can do, show us and let us hear it! There's no way any console or PC could compete for the price.

Why don't Commodore ask a few non-professionals to create a commercial using only Amigas and Amiga software. It should be cheap to make, and really show off the capabilities of the Amiga. Let's have a contest in Europe for Amiga owners to produce a good commercial. A programmer, video-artist, composer and gamer could really make a great Amiga commercial together. And the competition itself would have great promotional value. They could then run the winning video on channels with a young and broad audience (MTV, superchannel etc).

With the launch of the A1200 and A4000 Commodore are finally ready for the Nineties, but maybe it's time to show the rest of the world.

Kurt Decoene, Wevelgem, Belgium

A fine idea. It is often said that the Amiga has succeeded despite Commodore's marketing, rather than because of it. Though to be fair to Commodore they did come up with a TV commercial that wasn't half bad just before Christmas.

But the machine is so powerful that it really ought to be given a chance to sell itself. A self-booting, rolling, promotional demo on every A1200 on display in the Dixons stores around the country would be a good start. The guys who wrote the State of the Art demo, reviewed in PD Demo Zone on Page 185, could no doubt knock up something rather special. The Amiga's strong position in the video/effects/morphing fields really give strength to your proposal. And the youth lifestyle mags have just got on to the street cred of PD demos and their excellent rave soundtracks. So come on Commodore, give these demos a chance. Sega and Nintendo have created huge media attention for machines with all the creative potential of a console.

DEAR AMIGA POWER

We would just like to complain about...

- The use of women as objectives to reach the end of games, it is disgusting!!
- The absence of strip poker games for females and homosexuals.

We are glad to see...

- That your magazine is priced correctly.
- That *Rainbow Islands* was included in the top 100 games.
- That the bloke in the cell next to us had his letter about *Rainbow Islands* printed in one of the recent editions
- That staples are not used in binding your magazine because we aren't allowed sharp implements.

Hannah Lectore, Jenny Toolles and Shona Legge

We would like to say that...

■ *It is disgusting, but since there are more (lots more) male, heterosexual Amiga gamers than of any other sexual orientation, it's probably predictable. I think you'll find this answers both of your first two points.*

We are glad that you're glad about the other things.

- *Our magazine is priced correctly, I just looked on the front of the issue.*
- *What top 100 games? I'm not quite sure what you're talking about, but *Rainbow Islands* certainly deserves to be in any round-up of all time great Amiga games.*
- *Erm... what letter? did you by any chance mean to send this to Amiga Power?*
- *Amiga Format doesn't use staples either, it's called perfect binding.*

FRENCH LETTER

Could you please tell me where to find your magazine

on the French territory? Is that impossible or must I subscribe to *Amiga Format*?

Patrick Suberville, La Réole, France

Nous avons vu pendant plusieurs vacances dans votre pays qu'on peut acheter Amiga Format - enfin, dans les grandes villes, vous êtes sur de le trouver. Si vous n'arrivez pas encore à le trouver, Patrick, je crois qu'il serait plus simple de faire un abonnement. Comme ça, vous êtes sur de recevoir un numéro d'Amiga Format tous les mois et aussi vous vous sauvez la peine de chercher partout dans les tabacs. Qui plus est, vous recevez tous les mois du fantastique software qui est tout à fait gratuit.

NO JOY STICK

I just want to say how annoyed I was when I saw that the A1200 had the same useless 9-pin joystick ports as the the now ageing A500. I believe that many people would like to see multi-button joysticks or joypads on the Amiga, which have at least three or four fire-buttons with separate functions. This would make action games, beat-em-ups and shoot-em-ups more enjoyable.

I strongly suggest that you and your readers write to Commodore and advise them to relaunch the A1200 with joystick ports with this capability.

Stephen Ray, Harrow Weald

*Stephen, go get a Sega Mega Drive, you know the one, the console that has joypads with three fire-buttons. Now take a look down the hole that the joypad plugs into, and count the pins. I think you'll find there are nine, just like the old-fashioned out-of-date, almost prehistoric ones on the A1200. Now read the letter entitled *Sega Power* on Page 204. You see it's not the number of pins that's at fault, it's the type of joystick that people buy, and the way the software is written to support multiple joystick buttons. The thing is that since most Amiga owners have crappy one button joysticks, few games support more buttons.*

EVERYONE'S A WINNER BABE

THE AMIGA FORMAT NODDY COMPETITION

Winners of a full set of BBC Noddy books, courtesy of The Jumping Bean Company are Andy Brown of Hythe, I Purdy of Leamington Spa, V Lindsay-Addy of Leytonstone, R Pound of Southampton, Owain Perry of Pontypool, Kira Phillips of Looe, Emma Newton of Newcastle upon Tyne, Hannah and Frances Osis of Chichester, Sally Purvis of

Kent and Samantha MacDonald of Witham. We hope you enjoy the books.

RAVING COMPO

The two lucky winners of a Casio MIDI keyboard and a copy of the Rave software are Ian Southwood of Salisbury and Mr D Clifford (surely not the one who was in Creedence Clearwater Revival) of Great Yarmouth. Ten not quite as

lucky runners-up are M Lieberman of Hornchurch, Laurence Robbins of Bishopstortford, Darren Tremaine of Maidstone, Darren Baskill of Sheffield, Peter Cowburn of Otley, Matthew Rhodie of Barnsley, Paul Atkins of Retford, Karl Foster (no! not the ex-editor of the *Amiga Format Specials*) of Leicester, H Johnston of Kingsteignton and H Harris of Bristol.

Spot the shot 44



Simply identify the game that this small portion of a screenshot is from, write the answer on a postcard with your name and address and send it in to us.

The address is Spot the Shot 44, *Amiga Format*, 30 Monmouth St, Bath BA1 2BW. The first correct entry out of the hat every month will win a fabulous *Amiga Format* T-shirt!



The winner of Spot the Shot 42 is Mr MH Thomas, who is from Bolton. As usual the prize is a very wonderful *Amiga Format* T-shirt, which he can wear down the local pub to the chagrin of all his friends.

ADVERTISERS INDEX

Power Computing.....	IFC,3,141,202,IBC.....	0234 843 388	Harwoods.....	100-103,143.....	0773 520 252
Ocean.....	36,80,OBC.....	061 832 6633	Datagem.....	106.....	071 608 0624
Core Design.....	9.....	0332 297797	Europress Software.....	109.....	0625 859 444
Entertainment International.....	11.....	0268 541126	Softstore.....	111,191.....	0753 686 000
Intermediates.....	12-13.....	0279 600 770	WTS.....	112-113,175.....	0582 491 949
The Producers.....	14.....	0480 496 446	Ad Energy.....	117.....	
Digital Integration.....	18.....		Grapevine.....	117.....	0101 914 357 2424
Psygnosis.....	21,73.....	051 709 5755	Kontax.....	117.....	0628 773212
Software Expressions.....	22.....		ZCL.....	118-119.....	0543 414817
1st Computer Centre (Leeds).....	26-27.....	0532 319444	Software Supreme.....	120.....	081 365 0344
Digita.....	28.....	0395 270273	Datel Electronics.....	125-127.....	0782 744707
Siren Software.....	33.....	061 724 7572	Mac Format.....	128.....	0225 442244
Phoenix.....	34-35.....	0532 311932	Novatech.....	130.....	0705 664 144
Domark.....	41.....	081 780 2222	Battleaxe.....	134-135.....	0603 261060
Amiga Format Specials.....	42-43.....	0225 442244	Future Music.....	140.....	0225 442244
Poste Haste.....	44.....	0227 764204	Trilogic.....	144-145.....	0724 691 115
Software Demon.....	48.....	0736 331 039	MD Office Supplies.....	148.....	0689 861 400
Gasteiner.....	49.....	081 365 1151	Indie.....	150-153.....	0606 43860
New Horizon.....	52.....	0989 750 260	Gold Disk.....	156.....	0101 310 320 5080
Diamond Computers.....	53-58.....	0703 232777	Evesham Micros.....	160-161.....	0386 765500
Microprose.....	63,87.....	0666 504326	MJC.....	164.....	0462 481166
Direct.....	64.....	0908 379550	Ladbroke.....	166.....	0689 861400
316 Supplies.....	66.....	0446 421316	Eagle Software.....	167.....	081 361 2733
Inovatronics.....	67.....		United PD.....	170-171.....	0983 529594
Audition.....	70-71.....	0780 55888	Direct Computer Supplies.....	175.....	0630 311 471
We Serve.....	74.....	0705 325354	17 Bit Software.....	176.....	0924 466982
System Compbac.....	75.....		PD Soft.....	179.....	0705 566933
Yew Tree.....	75.....		Anglia PD.....	180.....	0394 2833494
Dataplex.....	75.....	0753 53557	PD Warehouse.....	180.....	081 290 6140
Sidmouth Software.....	75.....	0395 67073	Barkman.....	183.....	081 541 5941
Games Master.....	76-77.....	0225 442244	Owl Associates.....	183.....	0543 250377
Rubysoft.....	78.....	071 381 8998	Omnidale.....	183.....	0332 291219
Silica.....	79,93,97,107,129,157.....	081 309 1111	Artworks.....	183.....	0469 588138
Brighton Computer Supplies.....	82-83.....	0273 506269	Walkabout Music.....	183.....	0726 813 807
Amiga Power.....	84,85,104.....	0225 442244	Selectafont.....	183.....	0702 202835
Hobbyte.....	88-89.....	0727 56005	Amiga Shopper.....	184-185.....	0225 442244
ACS.....	92.....	091 455 4300	16 Bit Centre.....	186.....	0423 526322
RC Simulations.....	92.....	0272 550900	Only The Best.....	191.....	0272 401315/6
Kosmos.....	92.....	0525 873 942	Commonside.....	191.....	081 3307533
Krisalis.....	92.....	0709 372 209	Computermates.....	194.....	0753 631101
Talking Birds.....	95.....	0702 523 607	Snap.....	199.....	0703 457111
LCL.....	96.....	0491 579345	Romford Computer Centre.....	200.....	0708 735006
Firecrest.....	96.....	0875 850028	Analogic.....	200.....	081 541 4671
Premier Mail Order.....	96.....	0268 271172			

PREMIUM BULK 3.5" DS/DD DISKS

25	10.99
50	20.50
100	36.99
250	84.99
500	164.99



ALL DISKS ARE FULLY GUARANTEED AND ARE COMPLETE WITH LABELS

3.5" SUPERIOR LOCKABLE DISK BOXES

100 Capacity	4.49
120 Capacity	6.49

3.5" PREMIUM DISKS WITH OUR BOXES

100 Cap. box + 50 3.5" DS/DD	24.49
120 Cap. box + 100 3.5" DS/DD	42.99
90 Cap. Bank box + 50 3.5" DS/DD	29.49

3.5" BANK BOX - 90 CAPACITY

A SUPERB PRODUCT WHICH IS BOTH LOCKABLE AND STACKABLE

ONE	9.95
TWO	18.95
THREE	26.95



SNAP COMPUTER SUPPLIES LTD

HOTLINE

0703 457111



RIBBONS - POST FREE

Full Mark Brand	2 off	4 off
	PRICE EACH	
Citizen 120D/124D Swift 24	2.75	2.55
Citizen Swift 24 Colour (Compat)	12.95*	
Panasonic KXP1080/1123/1124	3.25	3.05
Star LC10/LC20	2.60	2.40
Star LC10-4 Colour	5.90	5.70
Star LC24-10	2.95	2.75
Star LC24-10 Colour (Compat)	9.95*	
Star LC200	3.00	2.80
Star LC200 Colour (Compat)	9.95*	
Star LC24-200	2.95	2.75
Star LC24-200 Colour (Compat)	9.95*	
Ribbon re-ink	12.95	

Minimum order - 2 ribbons, except those marked with an asterisk *

ACCESSORIES - POST FREE

Amiga External Drive	49.99
A500 1/2MB upgrade with clock	23.99
A500 1/2MB upgrade without clock	21.99
Mouse Mat	2.99
Mouse Holder	2.99
Roll 1000 3.5 Disk Labels	8.99
Amiga A500 dust cover	3.50
Phillips monitor cover	3.99
Star LC10, Star LC20 covers	
Star LC24-10, Star LC24-200 covers	3.99

All products are subject to availability - All prices include VAT. Please add £3.50 p+p for disks and boxes. E&OE.

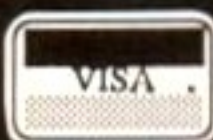

SNAP COMPUTER SUPPLIES LTD Fax: 0703 457222
Unit 16, The Sidings, Hound Rd, Netley Abbey, Southampton SO3 5QA



ROMFORD COMPUTER CENTRE

PLEASE SEND CHEQUES/PO/ACCESS/VISA NO AND EXPIRY DATE TO: ROMFORD COMPUTER CENTRE, 72 NORTH STREET, ROMFORD RM11DA.
POST & PACKING INCLUDED EXCEPT NON-EEC COUNTRIES. PLEASE ADD £5.00 PER ORDER FOR AIR MAIL.

TELEPHONE ORDERS: 0708-735006/7.

CALLERS WELCOME MON TO SAT 10AM - 4PM

ITEMS MARKED # ARE NOT YET AVAILABLE AND WILL BE SENT ON DAY OF RELEASE.

TITLE	PRICE	TITLE	PRICE	TITLE	PRICE
1st Division Manager	6.99	Eye Of Beholder 2	22.99	Pang	6.99
3D Con Kit 2	29.99	F16 Combat Pilot	8.99	Panzer Kick Boxing	6.99
A Train #	22.99	Falcon	11.99	Parasol Stars	16.99
A320 Airbus	24.99	Falcon 3 #	24.99	Pathway To Power #	19.99
Addams Family	16.99	Fatal Strokes #	19.99	PGA Tour Golf +	19.99
Adventurers	14.99	Fire And Ice	16.99	Pinball Fantasies	19.99
Air Warrior	23.99	Fire Force	16.99	Piracy #	19.99
Alien 3 #	19.99	Flashback #	phone	Populous 2	20.99
Amos	32.99	Flight Of Intruder	11.99	Premiere	16.99
Amos 3D	16.99	Football Crazy	phone	Prince Of Persia	6.99
Amos Creator	29.99	Football Director 2	16.99	Puffy's Saga	6.99
Amos Pro	44.99	Football Manager 3 #	14.99	Putty	16.99
Apidya	9.99	Formula One GP	22.99	Quest And Glory	14.99
Aquatic Games	17.99	Frontier (Elite 2) #	22.99	R Type 2	6.99
Arabian Nights #	phone	Fun School 2 (6-8)	6.99	Ragnarok #	19.99
Archer Maclean Pool	19.99	Fun School 2 (8+)	6.99	Railroad Tycoon	22.99
Arsenal FC #	16.99	Fun School 2 (U6)	6.99	Rainbow Islands	6.99
AVB-B Harrier	22.99	Gadget Twins #	16.99	Rampart #	phone
B17 Flying Fortress #	22.99	Goblins 2	21.99	Reach For The Skies #	22.99
BC Kid #	16.99	Gunship 2000 #	22.99	Road Rash	17.99
Bills Tomato Game #	17.99	Guy Spy	18.99	Robocop	6.99
Birds Of Prey	22.99	Harpoon	22.99	Robosport #	phone
Black Crypt	17.99	Heimdall	12.99	Secret Of Monkey Island	17.99
Bubble Dizzy	6.99	Indy Jones Atlantis Adventure	25.99	Secret Of Monkey Island 2	24.99
Campaign	22.99	Int Rugby Challenge	17.99	Sensible Soccer 92/93 Ed	16.99
Champ Manager	16.99	Jaguar XJ220	14.99	Shadow Of The Beast 3 #	21.99
Chuck Rock	7.99	James Pond 3 #	16.99	Shoot Em Up Con Kit	6.99
Chuck Rock 2 #	14.99	Jimmy Whites Snooker	19.99	Shuttle	19.99
Civilization	22.99	John Madden Football	17.99	Smash TV	6.99
Combat Classics	19.99	KGB #	23.99	Soccer Kid #	phone
Covert Action #	22.99	Legends Of Valour #	22.99	Spellbound Dizzy	6.99
Crazy Cars 3	16.99	Lemmings 2 The Tribes #	17.99	Sports Masters	phone
Curse Of Enchantia	16.99	Leathal Weapon	19.99	Street Fighter 2	19.99
Demoniak	10.99	Lionheart #	19.99	Stun Runner	6.99
Desert Strike #	19.99	Lotus Challenge 3	16.99	Super Hang On	6.99
Dizzy Collection	16.99	Lotus Esprit Turbo	6.99	The Manager	19.99
Dizzy Panic	6.99	Lure Of Temptress	19.99	Transarctica #	phone
Doodlebug	14.99	Magicaland Dizzy	6.99	Trivial Pursuit	6.99
Dragons Lair 3	22.99	McDonald Land #	16.99	Trolls #	phone
Dream Team (Simp WWF T2)	19.99	Mini Office	44.99	Turican 2	6.99
Dune	19.99	Motorhead #	19.99	Turtles-Coin OP	9.99
Dungeon Master & Chaos	21.99	Myth	9.99	Uridium 2 #	17.99
Dynablasters	19.99	New Zealand Story	6.99	Voyager	6.99
Easy Amos	26.99	Nick Faldo Golf #	phone	Wing Commander	23.99
Epic	19.99	Nicky Boom #	phone	Wizkid	16.99
Eye Of Beholder	19.99	Nigel Mansell W Champ	18.99	WWF Euro Rampage	16.99
		No Second Prize #	19.99	Zool	16.99

LEMMINGS 2 ...£19.99

DREAM TEAM
SIMPSONS, WWF,
TERMINATOR 2.
ONLY £19.99

CURSE OF
ENCHANTIA
ONLY £16.99

WORD PROCESSING:- PRICE

Excellence 3.0	56.99
Kindwords 3.0	36.99
Penpal	51.99
Protex 5.5	94.99
Quickwrite	28.99
Scribble (Platinum)	26.99
Wordworth 1.1	79.99
Word Perfect 4.1	139.99

SPREADSHEETS:-

Advantage	69.99
Maxiplan 4.0	34.99

ACCOUNTING:-

Arena Accounts	79.99
Home Accounts 2	39.99
Per. Finance Man	24.99

BUNDLES:-

Compendium 6	29.99
Works Platinum	59.99

PROGRAMMING:-

Amos the Creator	32.99
Amos 3D	22.99
Amos Compiler	19.99

ANALOGIC
ANALOGIC
ANALOGIC

Analogic Computers (UK) Ltd
Unit 6, Ashway Centre,
Elm Crescent
Kingston-upon-Thames
Surrey KT2 6HH

Telephone Mon-Fri 9am-7pm

Sat 9am-5.30pm

081-546 9575

Tel/Fax: : 081-541 4671

REPAIRS WHILE-U-WAIT !!

- * AMIGA A500 REPAIRS WITHOUT DIAGNOSTIC FEES
- * FIXED CHARGES
- * FAST TURNAROUND
- * MANY REPAIRS DONE WHILE-U-WAIT
- * WE PROVIDE PICK-UP SERVICE FOR REPAIRS FOR ONLY £5.00 + VAT

£49.95
including NEXT DAY
DELIVERY by
COURIER SERVICE

COMPUTERS

A600	POA
A600 + HD	POA
A1200	£399.95

MONITORS

CM 8833II	POA
SC 1435	£199.95
Philips 15" TV/monitor, remote control + scart cable	£239.00
Philips 15" TV/monitor, as above plus Fast text	£269.00

ACCESSORIES

Amiga 512K RAM +clock	£24.95	Mouse Mat	£4.95
Amiga Plus 512K RAM	£34.95	Dust Cover	£4.95
Amiga Plus 1 Meg	£49.95	Super Pro Zipstick	£14.95
Amiga/Atari Squik Mouse	£14.95	Amiga Power Supply	£39.95
Amiga Scart Cable	£14.95	10 Sony Blank Disks	£9.95
Rom Sharer	£19.95		

FLOPPY DRIVES

1 Meg 3.5" internal	£44.95
1 Meg 3.5" external	£59.95



* All prices include VAT and NEXT DAY DELIVERY subject to availability
* Fixed charge for repair does not include disk drive replacement nor keyboard
* All prices subject to change without notice * We reserve the right to refuse any Amiga repair

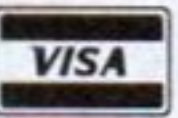

Software



If you have a game, or serious program that doesn't work when you get it home from the shop, take it back, as soon as possible, and remember to keep your receipt. Some shops are often not keen to accept software back because they think people just take it home, pirate it then take it back for exchange. If you do do this kind of thing, shame on you, and if you do have problems, you deserve them.

If you've had a game for a while and it goes wrong, send the disks, but not the manual and packaging, back to the software house who publish the games, and they will replace them for you. There may be a small charge for this service, but it'll be a lot cheaper than buying a new copy of the game.

If you need a cheat or tip for a game, make sure you've checked out the GameBusters section of **Amiga Format**. If there's nothing in there, then write to Andy Nuttall at the address on Page 195.

Telephone numbers

If you need the telephone number of a software or hardware company, why not look for a review of one of their products in **Amiga Format**. We print the numbers of all the serious soft and hardware companies, and from next month we'll print the games companies' numbers too. Or why not buy a copy of the **Amiga Format Special Complete Software Guide**, inside which there is a massive list of virtually every software company (both games and serious) in existence, with addresses too – it's an invaluable reference. Otherwise, why not try the directory enquiries, it is their job after all. Otherwise why not try the directory enquiries, it is their job after all.

Give us a call

Here at Amiga Format we have always tried to help our readers as much as we can, including taking your telephone calls every Tuesday. But before you ring us, there may be an easier way of getting the information you need...

Coverdisk



OK, we admit it, the Coverdisk is our responsibility, we made it and we're here to help you if it's giving you a problem. But before you ring us up – hold on a second. Have you read the Coverdisk pages fully? We get loads of people ringing us to say their Coverdisks don't work, and when we ask the hard questions, the ones that have to be asked, it turns out they simply haven't bothered to read the instructions on the coverdisk pages. OK, OK! I know you're anxious to get playing with all the excellent

software on your disk, but Pat spends a lot of time writing those instructions to help you get the most from your Coverdisk, so you could at least read 'em.

If you should be so unlucky as to get a faulty disk, send it to the address printed on the Coverdisk pages, and they'll replace it for you. Don't ring us, because we'll just tell you to send it to them anyway.

Hardware

Computer hardware isn't cheap, and if you buy a piece of kit, you have a right to expect it to work correctly. This is your right by law, and if your hardware isn't working from new, you can have a replacement or your money back. But we can't give you either, but the shop you bought it from can, so call them. If they won't help, and most will, call your Trading Standards Office.

If you have problems with older hardware, call the manufacturer. Most have a technical support line. Remember, they made the thing in the first place, so they probably have a better idea what could be wrong than even the **Amiga Format** team.

If you buy a piece of hardware from a show, or a similar event, then make sure you keep hold of your receipt. We get lots of call from people saying that they have bought some kit, but they don't know who from. If you don't know, how on Earth can we be expected to work it out?

If you need some technical help, send your letter to Pat McDonald, Workbench at the address on Page 195 of this issue.

If all else fails

The information on this page is intended to help you. I mean there's no point ringing us if all we're going to do is tell you to ring someone else, or read the instructions on Page six, now is there? But if you have read the information above, and tried those avenues first, and you are still stuck, we will try and help you. Give us a call on Tuesday, between 10 am and 6 pm Please try to remember, we're very busy bringing you Amiga format, so if you can get your information through one of the methods suggested above, please do. But if you're really stuck, we are there for you.

Amiga Format Issue 44

EDITORIAL CONTRIBUTORS

Jason Holborn
Tim Smith
James Leach
Brian Larkman
Phil South
Huw Llewellyn
Ed Ricketts
Andy Lowe
Sarah Tanser
Andy Hutchinson
Trenton Webb

PHOTOGRAPHY Ashton James, Bradford-on-Avon;

COLOUR ORIGINATORS Phoenix Repro
PRINTERS Chase Web, St Ives PLC, Plymouth

NEWS TRADE DISTRIBUTION UK

Future Publishing 0225 442244
NEWS TRADE DISTRIBUTION OVERSEAS:
MMC Ltd 0483 211222
CIRCULATION DIRECTOR Sue Hartley 0225 442244



Home of Britain's finest magazine.

AMIGA FORMAT

Amiga Power • Amiga Shopper •
ST Format • Sega Power • Mega
Super Play • Games Master • Total
Future Music • Amstrad Action •
Your Sinclair • Commodore Format
PC Answers • PC Plus • PC Format
PCW Plus • Cycling Plus
Mountain Biking UK • Needlecraft •
Classic CD • Crosstitch

Your guarantee of value

This mag comes from Future Publishing, a company founded just seven years ago but now selling more computer magazines than any other in Britain. We offer:

Better advice. Our titles are packed with tips, suggestions and explanatory features, written by the very best in the business.

Stronger reviews. We have a cast-iron policy of editorial independence and our reviews give clear buying recommendations.

Clearer design. You need solid information fast. So our designers highlight key

elements by using charts, diagrams, summary boxes, and so on...

Greater relevance. At Future, Editors operate under two golden rules:
● Understand your readers' needs.
● Then satisfy them.

More reader interaction. We draw on readers' contributions, resulting in the liveliest letters pages and the best reader tips. Buying one of our magazines is like joining a nationwide user group.

Better value for money. More pages, better quality – magazines you can trust.

Award winning innovative products from Power Computing Ltd

A2000 Hard Cards

GVP Series 2 HD

- Up to 8Mb SIMM RAM on-board
- Supports external SCSI devices
- 14MHz SCSI controller

Bare	£129		
40QMB 0MB	£249	80QMB 0MB	£349
40QMB 2MB	£299	80QMB 2MB	£399
40QMB 4MB	£349	80QMB 4MB	£449
40QMB 8MB	£429	80QMB 8MB	£539

Nexus Hard Card



- Up to 8MB RAM on-board

Bare	£129		
40QMB 0MB	£249	80QMB 0MB	£349
40QMB 2MB	£299	80QMB 2MB	£399
40QMB 4MB	£349	80QMB 4MB	£449
40QMB 8MB	£429	80QMB 8MB	£539

Bare SCSI Hard Drive

40 Quantum ..	£179	80 Quantum ..	£229
---------------	------	---------------	------

(Suitable for GVP G-Force, GVP HD or Nexus HC)
Other sizes of HD available, please call

RAM Expansion

- Aries A1500 / A2000 RAM

2MB	£129	6MB	£209
4MB	£169	8MB	£249

Macintosh Emulator

"This really is the best emulator we've seen for the Amiga. It behaves just as if you really were using a Mac"

Amiga Format Sept 1992

AMax-II Plus

- Amiga 1500 and above
- Runs Mac software
- Runs System 7
- Full support for all SCSI Mac peripherals and the ability to read Mac disks in your drives
- 68020/68030 compatible
- AppleTalk emulation
- Can use Amiga ECS
- Easy to install

AMax-II Plus£229
(Mac ROM chips required)

24-Bit Colour

OpalVision

- 24-bit graphic card
- 16.8 million colours available
- Operates in all standard Amiga resolutions
- VLSI Microcode graphics co-processor
- Double buffered 24-bit and 15-bit animation is available in all resolutions
- 'Palatte-mapped' design updates screen colours in real-time. Fade pictures in and out and change their palettes
- Equipped with 1.5MB of display RAM
- Auto-config for NTSC or PAL
- Available for all Amigas

Software included

OpalPaint

- 24-bit painting and image processing

OpalPresents

- Presentation program
- Control OpalVision images, Amiga graphics and live video
- Includes fades, effects etc.
- Many more features

King of Karate

- 24-bit computer game
- Exciting karate competition
- Demonstrates OpalVision capabilities

OpalVision£699
More information available
OpalVision roaster chip available soon

Monitors

"For a monitor of this quality, the CM8833 is worth every penny"

Amiga Format Sept 1992

"The 4FG is an absolutely smashing monitor that beats every competitor"

Amiga Format Sept 1992

Philips CM8833 Mk2

- With cable
- Available with Lotus Turbo Challenge 2
- On-site maintenance

CM8833 Mk2£199

NEC Multisync 4FG

- For use with Flicker Fixers
- Very high quality
- Built-in degausser
- 15" Screen

NEC Multisync 4FG£549

Optical Hard Drive



- Manufactured by Power Computing
- 128MB on one optical disk
- Read and write optical disks
- 40ms running speed
- Built-in power supply
- High power cooling fan
- 25-way and 50-way SCSI ports
- Thru'port built-in
- SCSI ID switch
- Compatible with major SCSI controllers

128MB optical drive (Internal)£729
128MB optical drive (External)£999
128MB 3.5" optical disk£39.95 each
SCSI controller card
for A1500 / A2000£129
(Compatible with Amiga, PC, and Mac. A SCSI controller is required on the Amiga and PC)

Floptical Disk Drive

- Stores 20MB on one 3 1/2" disk
 - Cost effective mass storage unit
 - Can be used as a 1.44MB floppy with Amiga DOS and AMAX
 - AMAX compatible with DMI Mac driver
 - Packs an entire back-up onto one floppy
 - Additional disks available
 - Internal version for A1500/2000/3000
 - External version for A500
 - SCSI Interface required
- Internal A2000 kit£289
Internal A3000 kit£289
External A500 kit£389
A1500£599

Accelerator

GVP G-Force

- 68030 accelerator board
 - 68882 Maths co-processor
 - DMA SCSI controller on-board
 - 68000 fall-back mode
 - Only CPU slot is used
 - Internal and external SCSI connector
 - Converts to hard card with Hard Drive mount kit
 - 32-bit RAM as standard
- 25MHz 1MB RAM£529
40MHz 4MB RAM£759
50MHz 4MB RAM£1249
Hard drive mount kit£35

Tel 0234 843388

Printers

All printers include cables and next day delivery

Star Printers

- LC200 colour£199
- LC24-200 mono£239
- LC24-200 colour£289

Citizen Printer

- Swift 24e£279
(includes colour kit and AMI)

Epson Printers

Laser

- EPL-4000£639
- EPL-4300£799
- EPL-8100£1349

Inkjet

- SQ-870£509
- SQ-1170£629
(132 column printer)

Dot Matrix

- LQ-570£289
- LQ-1070£449
(132 column printer)



- LQ-100£209
- LX100£189

Supra Modems

- Supra Fax Modem Plus£129
- Supra Fax Modem v32Bis£275
- Supra Modem 2400 (External)£75
- Supra Modem 2400 ZIplus (Internal)£134
- Supra 9600£210

Miscellaneous

- Power Mouse£15
- Optical Mouse£29.95
- Replacement optical mouse mat£9.95
- 10 Maxell disks, optical mouse, Zipstick£45
- Maxell multi-colour disks (10)£9.95
- Floppy disks bulk£POA
- Aviator 1 joystick£35
- Intruder 1 joystick£29.99
- Maverick 1 joystick£15.99
- Python 1 joystick£9.99
- Apache 1 joystick£7.99

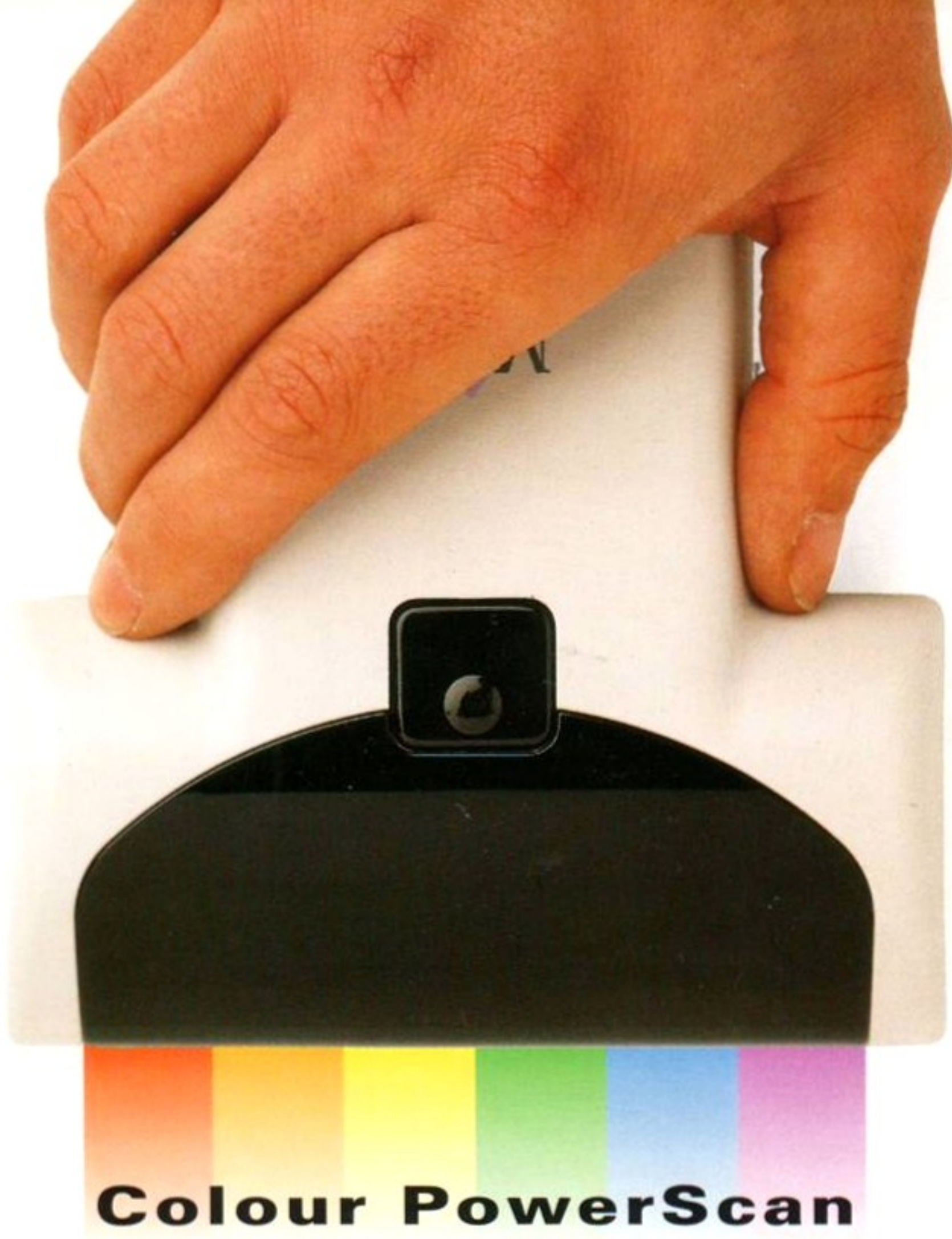

The Power Computing colour hand-held scanner for the Amiga is now available. This scanner offers the following features

- 4096 colours
- 50-400 DPI
- 4 Scanning modes
- Text
- Greyscale
- Colour halftone
- Colour

The Amiga interface plugs into an A1500/A2000/A3000/A4000 expansion slot with a separate version which connects to the expansion connector of the A500/A500+. The A500 version has a through-port which is compatible with all Amiga 500 expansion peripherals.

The software supplied with this scanner is the new PowerScan Professional 3, which also supports the greyscale scanner and will be available as an upgrade to existing users of PowerScan for £15.

Colour PowerScan v3.0 features

- Real-time 'True-feel' scan option in colour halftone mode
- Images are stored internally as 12-bit graphics, not HAM. This means that no quality is lost due to the Amiga only being able to display HAM images in 4096 colours

- Images are displayed as HAM pictures
- HAM images may be loaded from disk and edited using PowerScan 3
- Image size that can be handled is limited only by the amount of memory available
- Memory does not have to be chip memory as in many art packages
- Images can be saved in various file formats
- View whole image function
- Scale/rotate/skew image or clipboard by any amount
- Crop image
- Clean up, lighten or darken image
- Variable zoom mode
- Draw freehand, lines, circles, boxes and polygons in various fill patterns, brush sizes, paste modes, or with the clipboard image
- Clipboards may be scanned directly, or any shape can be cut from the main image
- The software is compatible with all Amigas
- Supports Workbench 2 and ECS screen modes

Colour PowerScan now available

New v3.0 Scan software

- PowerScan Colour v3.0£239
- PowerScan Greyscale v3.0£115
- PowerScan v3.0 software upgrade ...£15

The Amiga can only display 16 greyscales

POWER

Award Winning Manufacturers
Power products come with full technical support

Order Form

Name

Address

Postcode

Tel. No.

Description

Credit Card No.

Expiry Date

Signature

I enclose cheque/PO for £

Tel 0234 843388
Fax 0234 840234

Power Computing Ltd
Unit 8 Railton Road
Woburn Road Ind. Estate
Kempston Bedford
MK42 7PN



Established 1985

Specifications & prices subject to change without notice
All trademarks acknowledged, VAT included

(UK mainland only)
48Hr delivery £2.50 24Hr delivery £4.50
Parcel post delivery £1
(Not for orders over £50)

GET READY 4 THE INVASION

PLAY
THE
GAME
FOR...



COMIC RELIEF

HAVE AT LAST GRASPED THE FACT THAT ALL THE PEOPLE WORTH COMMUNICATING WITH THESE DAYS BUY COMPUTER GAMES - AND IT'S A REVELATION WHICH THEY HOPE IS GOING TO MAKE THEM A BLOOMING FORTUNE TO PLOUGH INTO BRILLIANT PROJECTS IN AFRICA AND THE UK.

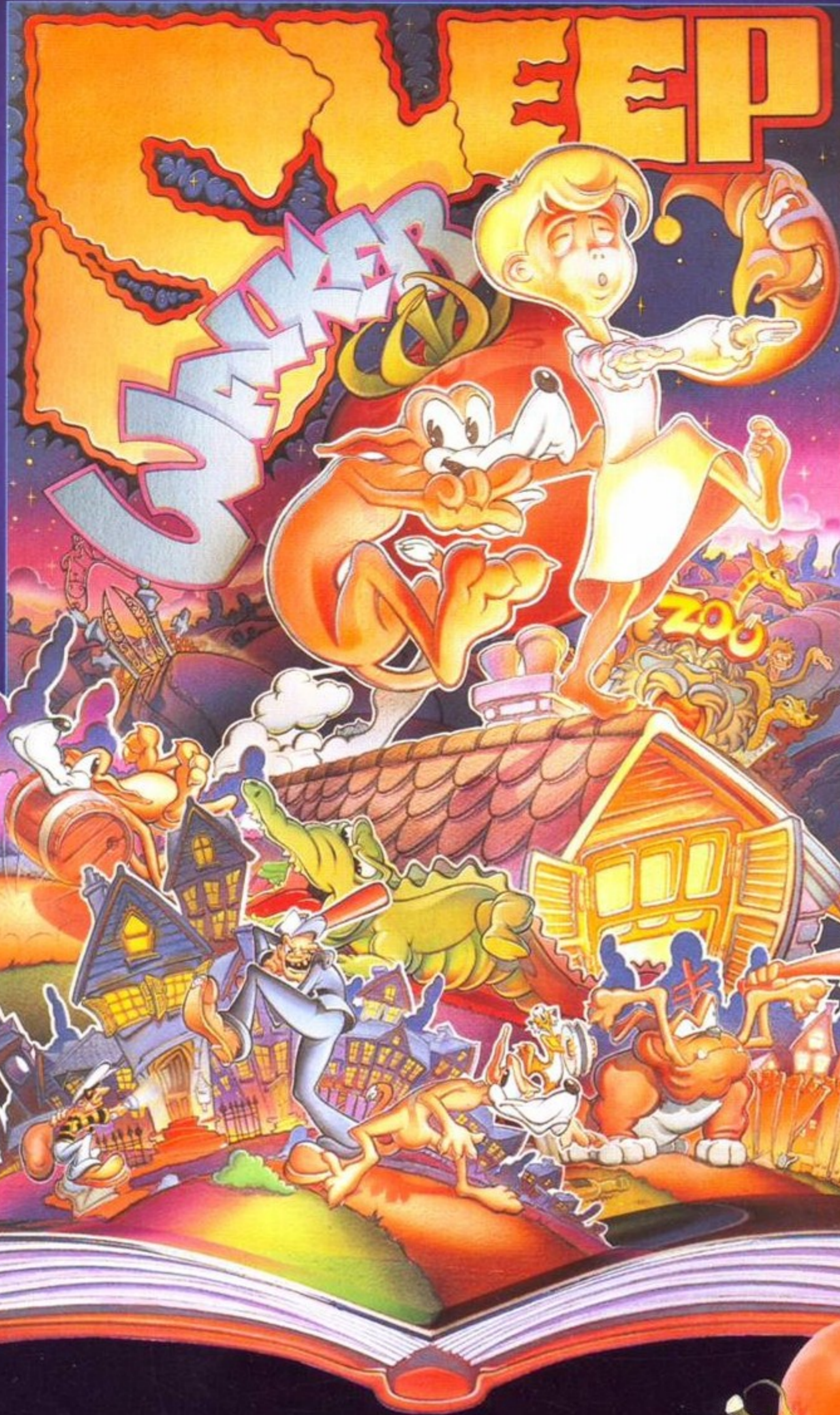

HERE ARE SOME IDEAS ON HOW YOU CAN GET ONTO THE SLEEPWALKER SPONSORSHIP TRAIL: BUY SLEEPWALKER - A DECISION YOU WILL NEVER REGRET - THE GAME IS VOICED BY LENNY HENRY, AND WORKED ON BY SOME OF BRITAIN'S FINEST COMIC MINDS (and a couple of gits who happened to be round that evening). A DONATION FROM THE SALES OF SLEEPWALKER WILL GO DIRECT TO COMIC RELIEF.

TAKE PART IN THE GREAT SLEEPWALKER CHALLENGE, WHICH WILL BE INVADING ALL THE BIG RETAIL CHAINS DURING THE WEEKS BEFORE RED NOSE DAY - MARCH 12th 1993. ORGANISE YOUR VERY OWN SPONSORSHIP CHALLENGES LIKE: BEATING YOUR HIGHEST SCORE - TAKE ON YOUR DAD, OR YOUR TEACHER, OR EVEN YOUR SCHOOL IN A SLEEPWALKER CONTEST. DREAM UP YOUR OWN HIDEOUS CHALLENGE TO HARRANGUE YOUR FRIENDS.



C64 (DISK & CASS.)

ATARI (STE ONLY)

CBM AMIGA

IBM PC



OCEAN SOFTWARE LIMITED · 2 CASTLE STREET · CASTLEFIELD · MANCHESTER · M3 4LZ
TELEPHONE: 061 832 6633 · FAX: 061 834 0650